

554

SCIENTIFIC LIBRARY



UNITED STATES PATENT OFFICE

GOVERNMENT PRINTING OFFICE

11-8825



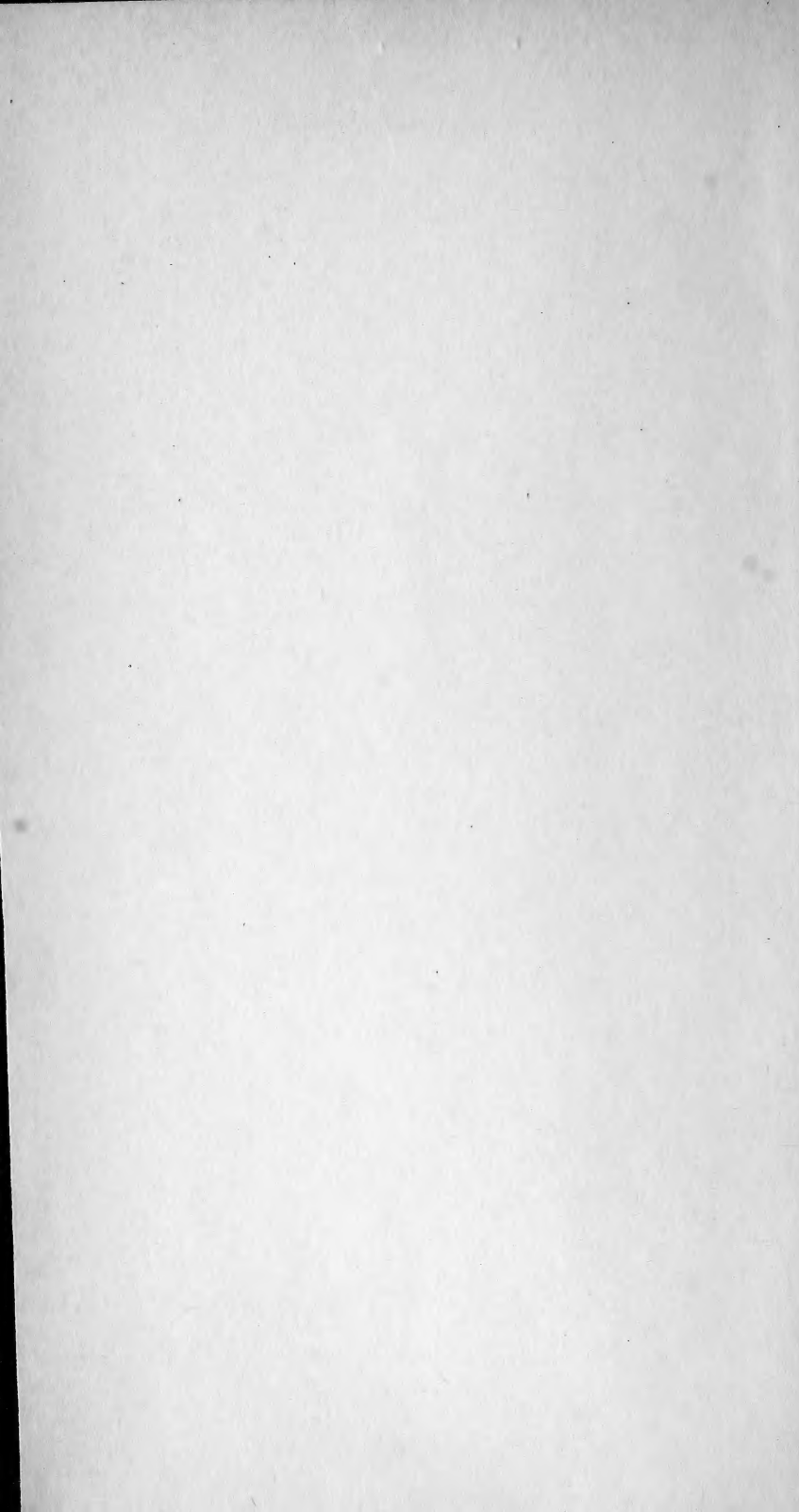

4
104980
Int
99

THE
LONDON, EDINBURGH, AND DUBLIN
PHILOSOPHICAL MAGAZINE
AND
JOURNAL OF SCIENCE.

CONDUCTED BY

SIR OLIVER JOSEPH LODGE, D.Sc., LL.D., F.R.S.
SIR JOSEPH JOHN THOMSON, O.M., M.A., Sc.D., LL.D., F.R.S.
JOHN JOLY, M.A., D.Sc., F.R.S., F.G.S.

AND

WILLIAM FRANCIS, F.L.S.

“Nec araneorum sane textus ideo melior quia ex se fila gignunt, nec noster
vilior quia ex aliénis libamus ut apes.” *JUR. JUR. Polit. lib. i. cap. 1. Not.*

VOL. XXXIX.—SIXTH SERIES.

JANUARY—JUNE 1920.

18209

LONDON:

TAYLOR AND FRANCIS, RED LION COURT, FLEET STREET.

SOLD BY SMITH AND SON, GLASGOW;—HODGES, FIGGIS, AND CO. DUBLIN;—

AND VEUVE J. BOYVEAU, PARIS.

Q1. P5

“Meditationis est perscrutari occulta ; contemplationis est admirari
perspicua Admiratio generat quæstionem, quæstio investigationem,
investigatiō inventionem.”—*Hugo de S. Victore.*

—“Cur spirent venti, cur terra dehiscat,
Cur mare turgescat, pelago cur tantus amaror,
Cur caput obscura Phœbus ferrugine condat,
Quid toties diros cogat flagrare cometas,
Quid pariat nubes, veniant cur fulmina cœlo,
Quo micet igne Iris, superos quis conciat orbes
Tam vario motu.”

J. B. Pinelli ad Mazonium.

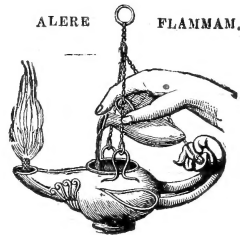

CONTENTS OF VOL. XXXIX.

(SIXTH SERIES).

NUMBER CCXXIX.—JANUARY 1920.

	Page
Capt. A. C. Egerton on the Determination of Chemical Constants	1
Prof. F. A. Lindemann on the Significance of the Chemical Constant and its Relation to the Behaviour of Gases at Low Temperatures	21
Prof. W. C. McC. Lewis on an Unsolved Problem in the Application of the Quantum Theory to Chemical Reactions.	26
Mr. D. L. Hammick on Latent Heat and Surface Energy.—Part II.	32
Dr. L. Silberstein: Contribution to the Quantum Theory of Spectrum Emission: Spectra of Atomic Systems containing a Complex Nucleus	46
Major W. T. David on the Calculation of Radiation emitted in Gaseous Explosions from the Pressure-Time Curves ..	66
Major W. T. David: An Analysis of the Radiation emitted in Gaseous Explosions	84
Mr. Loyd A. Jones on a Method and Instrument for the Measurement of the Visibility of Objects	96
Mr. Satyendra Ray on the Equivalent Shell of a Circular Current	134
Prof. C. V. Raman and Mr. Ashutosh Dey on the Sounds of Splashes. (Plate I.)	145
Prof. A. Anderson on Fresnel's Convection Coefficient	148
Mr. F. F. Renwick on the Fundamental Law for the true Photographic Rendering of Contrasts	151
Prof. I. W. D. Hack: A Table of the Radioactive Elements which indicates their Structure	155
Prof. W. B. Morton and Mr. T. C. Tobin on the Construction of a Parabolic Trajectory and a Property of the Parabola used by Archimedes	157

NUMBER CCXXX.—FEBRUARY.

	Page
Dr. L. Silberstein on the recent Eclipse Results and Stokes-Planck's Ether.....	161
Sir Oliver Lodge on a Possible Structure for the Ether.....	170
Prof. A. Anderson on the Spheroidal Electron.....	175
Dr. Norman Campbell on the Adjustment of Observations. I.	177
Dr. J. Prescott on the Buckling of Deep Beams. (Second Paper.) With an Appendix by Mr. H. Carrington.....	194
Miss Alice Everett on a Simple Property of a Refracted Ray.	223
The late Lord Rayleigh on Resonant Reflexion of Sound from a Perforated Wall	225
Dr. D. N. Mallik and Prof. A. B. Das on the Quantum Theory of Electric Discharge	233
Dr. G. Rudolf on Latent Heat and Surface Energy	238
Notices respecting New Books :—	
J. de Graaf Hunter's The Earth's Axes and Triangulation.	239

NUMBER CCXXXI.—MARCH.

Mr. G. A. Hemsalech on the Excitation of the Spectra of Carbon, Titanium, and Vanadium by Thermelectronic Currents. With special Reference to the Cause of Emission of Light Radiations by Luminous Vapours in the Carbon Tube Resistance Furnace. (Plates II.—V.)	241
Mr. E. T. Bell on Parametric Solutions for a Fundamental Equation in the general Theory of Relativity, with a Note on similar Equations in Dynamics	285
Mr. J. Tykocinski-Tykociner on the Mandelstam Method of Absolute Measurement of Frequency of Electrical Oscillations	289
Mr. L. C. Jackson on Variably Coupled Vibrations: Gravity-Elastic Combinations. Masses and Periods equal. (Plates VI. & VII.)	294
Mr. Také Soné on the Magnetic Susceptibilities of Hydrogen and some other Gases.....	305
Mr. Gilbert Cook: An Experimental Determination of the Inertia of a Sphere moving in a Fluid	350
Mr. F. Bates on a New Cadmium-Vapour Arc Lamp	353
Mr. S. P. Owen on Radiation from a Cylindrical Wall.....	359
Dr. L. Silberstein on the Measurement of Time—a Rejoinder to Dr. N. Campbell	366

Prof. J. Joly and Mr. J. H. J. Poole: An attempt to determine if Common Lead could be separated into Isotopes by Centrifuging in the Liquid State	372
Prof. J. Joly and Mr. J. H. J. Poole on the Effect of Centrifuging certain Alloys while in the Liquid State.....	376
Notices respecting New Books:—	
J. H. Jeans's Problems of Cosmogony and Stellar Dynamics	377
Prof. R. W. Wood's Researches in Physical Optics. Part II. Resonance Radiation and Resonance Spectra.	379
Prof. L. C. Karpinski, H. Y. Benedict, and J. W. Calhoun's Unified Mathematics	380
Prof. H. Lamb's An Elementary Course of Infinitesimal Calculus.....	381
Proceedings of the Geological Society:—	
Mr. H. Hamshaw Thomas on some Features in the Topography and Geological History of Palestine	383

 NUMBER CCXXXII.—APRIL.

Prof. W. E. Adeney and Mr. H. G. Becker on the Determination of the Rate of Solution of Atmospheric Nitrogen and Oxygen by Water.—Part II.	385
Dr. A. D. Fokker on the Contributions to the Electric Current from the Polarization and Magnetization Electrons.....	404
Prof. J. Kunz: An Elementary Theory of the Scattering of Light by Small Dielectric Spheres	416
Prof. R. W. Wood on Light Scattering by Air and the Blue Colour of the Sky.....	423
Prof. F. Slate: An Alternative View of Relativity	433
Mr. H. T. Flint: Applications of Quaternions to the Theory of Relativity.....	439
Dr. F. W. Aston on the Constitution of Atmospheric Neon. (Plates VIII. & IX.)	449
Intelligence and Miscellaneous Articles:—	
On the Equation of State, by Megh Nad Saha and Satyendra Nath Basu	456

 NUMBER CCXXXIII.—MAY.

Prof. W. M. Hicks on the Spectrum of Copper	457
Prof. A. O. Rankine on the Relation between Illumination and Electrical Conductivity in Selenium	482
Prof. Q. Majorana on Gravitation: Theoretical and Experimental Researches	488

CONTENTS OF VOL. XXXIX.—SIXTH SERIES.

	Page
Mr. J. S. G. Thomas on the Hot-wire Anemometer: its Application to the Investigation of the Velocity of Gases in Pipes. (Plates X.—XIII.)	505
Prof. C. V. Raman on a Mechanical Violin-Player for Acoustical Experiments. (Plate XIV.)	535
Mr. C. G. Darwin on the Dynamical Motions of Charged Particles	537
Major W. T. David on the Specific Heat of Carbon Dioxide and Steam	551
Mr. Iolo Jones on the Period and Decrement of an Oscillatory Electrical Circuit provided with a Short-circuited Secondary.	553
Prof. E. C. C. Baly on Light Absorption and Fluorescence.—V. The so-called Molecular Rotational Frequencies of Water.	565
Dr. Harold Jeffreys on Turbulence in the Ocean	578
Prof. A. O. Rankine and Dr. L. Silberstein on Propagation of Light in a Gravitational Field	586
Prof. F. Horton and Miss A. C. Davies on Critical Velocities for Electrons in Helium	592
Prof. H. S. Carslaw on Bromwich's Method of solving Problems in the Conduction of Heat	603
Dr. F. W. Aston on the Mass-Spectra of Chemical Elements. (Plate XV.)	611
Prof. A. Anderson on the Advance of the Perihelion of a Planet, and the Path of a Ray of Light in the Gravitation Field of the Sun	626
Notices respecting New Books:—	
Dr. A. N. Whitehead's An Enquiry concerning the Principles of Natural Knowledge	629
Sir Napier Shaw's Manual of Meteorology. Part IV. The Relation of the Wind to the Distribution of Barometric Pressure	631
Prof. A. W. Stewart's Stereochemistry	632

NUMBER CCXXXIV.—JUNE.

Sir J. A. Ewing on the Specific Heat of Saturated Vapour and the Entropy-Temperature Diagrams of certain Fluids	633
Prof. W. L. Bragg on the Crystalline Structure of Zinc Oxide.	647
Dr. G. Green on a Fluid Analogue for the Æther	651
Dr. A. H. Compton on Radioactivity and the Gravitational Field	659
Mr. R. Hargreaves on the Difference between Magnetic and Electric Energies as a Pressure	662
Mr. W. G. Bickley on the Diffraction of Waves by a Semi-infinite Screen with a Straight Edge	668

CONTENTS OF VOL. XXXIX.—SIXTH SERIES.

vii
Page

Mr. G. H. Livens on the Mathematical Relations of the Magnetic Field	673
Dr. H. J. S. Sand on the Cadmium-Vapour Arc Lamp.....	678
Sir J. J. Thomson on Mass, Energy, and Radiation	679
Miss Aniela Muszkat on the β -Recoil.....	690
Prof. R. Whiddington on the X-ray Spectra of the Elements.	694
Notices respecting New Books :—	
Dr. E. K. Rideal and Dr. H. S. Taylor's Catalysis in Theory and Practice.....	697
Dr. A. Macfarlane's Ten British Physicists	697
Proceedings of the Geological Society :—	
Prof. J. E. Marr on the Pleistocene Deposits around Cambridge.....	698
Index	700

PLATES.

- I. Illustrative of Prof. C. V. Raman and Mr. Ashutosh Dey's Paper on the Sounds of Splashes.
 - II.-V. Illustrative of Mr. G. A. Hemsalech's Paper on the Excitation of the Spectra of Carbon, Titanium, and Vanadium by Thermelectronic Currents.
 - VI. & VII. Illustrative of Mr. L. C. Jackson's Paper on Variably Coupled Vibrations.
 - VIII. & IX. Illustrative of Dr. F. W. Aston's Paper on the Constitution of Atmospheric Neon.
 - X.-XIII. Illustrative of Mr. J. S. G. Thomas's Paper on the Hot-wire Anemometer.
 - XIV. Illustrative of Prof. C. V. Raman's Paper on a Mechanical Violin-Player for Acoustical Experiments.
 - XV. Illustrative of Dr. F. W. Aston's Paper on the Mass-Spectra of Chemical Elements.
-

ERRATUM.

Page 169, line 13. For "per unit mass of matter" read "per unit mass of the ether."

THE
LONDON, EDINBURGH, AND DUBLIN
PHILOSOPHICAL MAGAZINE
AND
JOURNAL OF SCIENCE.

JAN 17 1920
[SIXTH SERIES.]

JANUARY 1920.

I. *Note on the Determination of Chemical Constants.*
By ALFRED C. EGERTON*.

Introduction.

UP till recently, the value of the integration constant of the vapour-pressure formula, known as the "chemical constant," has generally been considered to be about 3 (in absolute units). From affinity measurements, hydrogen appeared, however, to have a lower value (given in Nernst's 6th edition Theoretical Chem. as 1.6) while other substances such as iodine had a higher value about 4.0. The point arose whether the constant depended on the nature of the element; Sackur (*Ann. d. Phys.* xl. p. 67, 1913) and Tetrode (*ibid.* xxxviii. p. 434, and xxxix. p. 255, 1912) developed an expression, $i = \ln \frac{(2\pi m)^{3/2} \kappa^{5/2}}{h^3}$, wherein the constant is considered to be related to the atomic weight. Lindemann (*Phil. Mag.* vol. xxxviii. p. 177, 1919) has shown also from dimensional considerations that the integration constant of a monatomic substance should be equal to a universal constant plus one and half times the logarithm of the atomic weight.

It is of importance, therefore, to determine as accurately as possible the chemical constants of several monatomic elements. For this purpose, a careful calculation of the chemical constant of mercury has been made and the vapour

* Communicated by Prof. F. A. Lindemann.

pressures of zinc and cadmium previously investigated (Phil. Mag. vol. xxxiii. p. 33, 1917) have been used to deduce their chemical constants and give additional support to the validity of the result, which is in close agreement with the above theoretical expression.

Method of Calculation.

Most of the chemical constants have been calculated according to the formula :

$$\log p = -\frac{\lambda_0}{4.571T} + 1.75 \log T - \frac{\epsilon T}{4.571} + C,$$

where λ_0 is the molecular latent heat at absolute zero,
 ϵ is an individual constant (depending on change of spec. heat with temp.),
 C is the "chemical constant."

The constant 1.75 was derived from the assumption that at the lowest temperatures the molecular heats of all gases are 1.5 greater at constant volume and 3.5 greater at constant pressure than the molecular heats of the corresponding condensation products. Nernst's more recent work on specific heats shows such an assumption to be completely unjustifiable. Calculation of the constants λ_0 and C therefore by means of such a formula gives values which are without physical significance, and further the errors introduced by the necessity for combining the errors of temperature measurements in order to deduce the value of the constant, might render the final result liable to a serious discrepancy from the true value.

The vapour-pressure formula, derived directly from the Clausius-Clapeyron relation, $\lambda_T = RT^2 \frac{d \ln p}{dT}$, and $\lambda_T = \lambda_0 + \int_0^T C_p dt - \int_0^T c_p dt$, can be truly represented as follows :

$$\log_{\epsilon} p = -\frac{\lambda_0}{RT} + \int_0^T \frac{dT}{RT^2} \int_0^T (C_p - c_p) dT + i,$$

where $(C_p - c_p)$ is the difference of molecular heats of the vapour and the condensation product. As the molecular heat of the vapour remains constant 4.963 to the lowest temperatures, this becomes

$$\log_{\epsilon} p = -\frac{\lambda_0}{RT} + \frac{C_p}{R} \log T - \int_0^T \frac{dT}{RT^2} \int_0^T \left(c_v + \frac{9\alpha^2 v T}{\kappa} \right) dT + i. \quad (1)$$

The molecular heat of the solid can be integrated by

means of Debye's formula or Nernst-Lindemann's formula, and for temperature T higher than $(\beta\nu/T=1)$ it makes an inappreciable difference which of the two is employed.

The integration of the conversion term, derived from $c_p = c_v + \frac{9\alpha^2 v T}{\kappa}$ (where α is the linear coefficient of expansion, v the atomic volume, and κ the compressibility), is not so readily obtained. But it has been found sufficiently accurate to assume that $c_p = c_v + aT^{3/2}$, as suggested by Magnus and Lindemann (*Z. Elektrochem.* xvi. p. 269, 1910). As $\frac{9\alpha^2 v T}{\kappa} = aT^{3/2}$, it follows $a \propto T^{1/4}$, and this has been found to be approximately the case over a wide range of temperature for such substances as copper and silver, where the variation in coefficient of expansion with temperature has been measured. This holds at ordinary temperature up to fairly high temperatures. On the other hand, at very low temperatures where $c_v = aT^3$, a will vary as T^3 , provided, as is probable, $\frac{v}{\kappa}$ is a constant. The term $aT^{3/2}$ is a useful approximation, and the constant a can be obtained either from measurement of α , v , and κ at a definite temperature, or from the specific heat measurements compared with those calculated from Debye's formula.

The formula (1) given above, on integration, becomes

$$\ln p = -\frac{\lambda_0}{RT} + \frac{C_p}{R} \ln T - \frac{9}{4} \frac{\beta\nu}{T} + 3/2 [\ln(e^{\beta\nu/T} - 1) + \ln(e^{\beta\nu/2T} - 1)] - \frac{4}{15} \cdot \frac{a}{R} \cdot T^{3/2} + i,$$

which may be written more conveniently :

$$\log p = -\frac{\lambda_0}{4.571T} + 2.5 \log T + \frac{1}{4.571} \left[\frac{A_T - A_0}{T} \right] - 0.0583 aT^{3/2} + C, \quad (2)$$

where the term*

$$\left[\frac{A_T - A_0}{T} \right] = -\frac{3}{2} R \cdot \left[\frac{3}{2} \cdot \frac{\beta\nu}{T} - \ln(e^{\beta\nu/T} - 1) - \ln(e^{\beta\nu/2T} - 1) \right].$$

* The values of $-\left[\frac{A_T - A_0}{T} \right]$ and $\left[\frac{U_T - U_0}{T} \right]$ for different values of $\beta\nu/T$ are given in Pollitzer's 'Die Berechnung Chemischer Affinitäten' 1912, and the corrections to be introduced due to use of Debye's equation instead of the Nernst-Lindemann equation are to be found in *Sitzber. Akad. Wiss.* lii. p 1176 (1912).

For the determination of the chemical constants, therefore, $\beta\nu$, a , and two values of p must be known or one value of p and the value of λ_0 .

λ_0 can be obtained from λ_T and the molecular heat according to $\lambda_T = \lambda_0 + \int_0^T C_p dt - \int_0^T c_p dt$, or:—

$$\lambda_0 = \lambda_T - 4.963 T + 3/2 RT \left[\frac{\beta\nu/T}{e^{\beta\nu/T} - 1} + \frac{\beta\nu/2T}{e^{\beta\nu/2T} - 1} \right] + 2/5 aT^{5/2}$$

$$= \lambda_T - 4.963 T + T \left[\frac{U_T - U_0}{T} \right] + 0.4 aT^{5/2}. \quad \dots \quad (3)$$

Unless λ_T can be measured with accuracy directly, it has to be obtained from two or more measurements of the vapour pressure. Values of λ_T can be obtained at various temperatures from the vapour pressure by the Clausius-Clapeyron relation, and an average value of λ_0 can be so derived with fair accuracy. In dealing with a liquid, the latent heat of fusion (f_m) must be added to the molecular heat (c_p) term, the latter would be integrated to the melting-point according to the formula for the solid, and thereafter measurements of the change of atomic heat of the liquid (c_p) must be obtained and integrated to the desired temperature at which the vapour pressure is measured.

Discussion of Errors.

On differentiating formula (2),

$$\frac{dC}{dT} = -\frac{\lambda_0}{4.571 T^2} - \frac{2.5}{T} + \frac{1}{4.571} \left[\frac{A_T - A}{T} \right] \frac{1}{T} + 3/2 (0.0583 a T^{1/2}),$$

if λ_0 and $\beta\nu$ are known with accuracy, it is clear the higher the temperature the less the error in the determination of the constant C , provided the gas laws are applicable to the vapour.

On the other hand, as it may more often be convenient to eliminate λ_0 , and determine C from two values of p at two temperatures T_1 and T_2 , it will become of great importance to choose the two temperatures as widely separated as possible, otherwise the error may become great. Starting with two equations of the above form, the subtraction would lead to:

$$C = \frac{T_1}{T_1 - T_2} \log p_1 - \frac{T_2}{T_1 - T_2} \log p_2 - 2.5 \left\{ \frac{T_1}{T_1 - T_2} \log T_1 - \frac{T_2}{T_1 - T_2} \log T_2 \right\} - \frac{1}{4.571} \left[\frac{A_1 - A_2}{T_1 - T_2} \right] + 0.0583 a \left[\frac{T_1^{5/2} - T_2^{5/2}}{T_1 - T_2} \right];$$

and if C be differentiated with respect to T_1 :

$$\frac{dC}{dT_1} = \frac{T_2}{(T_1 - T_2)^2} \log \frac{p_2}{p_1} - 2.5 \left\{ \frac{T_1 - T_2 \log T_1/T_2 - T_2}{(T_1 - T_2)^2} \right\} \\ + \frac{1}{4.571} \frac{A_1 - A_2}{(T_1 - T_2)^2} + 0.0583 a \left[\frac{3/2 T_1 - 5/2 T_2 T_1^{3/2} + T_2^{5/2}}{(T_1 - T_2)^2} \right].$$

From which it is clear, that in order to reduce the error $\frac{dC}{dT}$, $T_1 - T_2$ must be as large as possible and T_2 as small as possible.

Neglecting the last two terms, because $(A_1 - A_2)$ is small and a is a very small constant, about 10^{-5} , it is seen that, if T_1 and T_2 are separated by about 50° and T_2 is about 250° and $\log \frac{p_2}{p_1}$ about 2, $\frac{dC}{dT}$ will be about 0.2, and so, supposing the constant to have a value of about 1.5, the error may be 40 per cent. for a one per cent. variation in T_1 . Thus the accuracy with which the vapour pressure must be measured, particularly regarding the fixing of the correct temperature, is very important, if true values of the constants are to be obtained.

Chemical Constant of Mercury.

These considerations will now be applied to the determination of the chemical constant of mercury. There appear to be no other cases in which the vapour pressure and specific heat of a monatomic substance have been measured with the same accuracy.

A number of determinations of the vapour pressure of mercury have been recorded. Those of Hertz, Ramsay and Young, Callender and Griffiths, Pfaundler, Morley, Gebhardt, Cailletet, Colardeau, and Rivière have been discussed by Laby (*Phil. Mag.* Nov. 1908), who concluded that the following formulæ summarized the work of these investigators, and gave the closest approximation to the true vapour pressures:—

From 15° to 270° C.,

$$\log p = 15.24431 - 2.367233 \log \theta - \frac{3623.932}{\theta};$$

and from 270° to 450° C.,

$$\log p = 10.04087 - 0.7020537 \log \theta - \frac{3271.245}{\theta}.$$

In 1909, Knudsen (*Ann. d. Phys.* (4) xxix. p. 179, 1909)

published a series of accurate measurements at relatively low pressures and discussed his results in connexion with those of Hertz, Ramsay and Young, Pfaundler and others. He finally arrives at the formula which agrees with that of Hertz in the value of the 2nd term, and holds up to 270° C.:

$$\log p = 10.5724 - 0.847 \log T - \frac{3342.26}{T}.$$

Smith and Menzies (J. Am. Chem. Soc. xxxii. p. 1434, 1910) have carried out accurate measurements of the vapour pressure of mercury from 250° C. upwards and arrive at the expression:

$$\log p = 9.9073436 - 0.6519904 \log T - \frac{3276.628}{T}.$$

The value for the boiling-point obtained from these vapour-pressure measurements 356.95 ± 0.1 C. agrees very closely with that obtained by Callender & Griffiths 357.05; whereas Knudsen's formula leads to a boiling-point 355.1 C. The following table gives a few points calculated from these formulæ:—

TABLE I.

T° abs.	Laby.	Knudsen.	Smith & Menzies.
630 B.Pt.	760.4 (ii)	787	760
473	17.81 (i)	17.41	17.22
373	0.276 (1)	0.2715	0.2794
273.4	0.00016 (1)	0.0001846	0.0002073
234.2 M.Pt.	—	0.000001970	0.000002354

Above 250° C. the values obtained by Smith and Menzies are probably correct within 0.2 per cent.; between 250° and 150° C. the data somewhat conflict, and the nearest value probably lies between that of Knudsen and that of Smith and Menzies, while at the lower temperature it seems probable (taking into consideration also Hertz and Pfaundler's results) that Knudsen's figures are within at least 0.5 per cent.

The extrapolation to the melting-point is reasonable, as there is no sufficient change in the specific heat of the liquid between 0° C. and the melting-point as would lead to an appreciable change in the value of the constant of the formula.

Haber and Kerschbaum (*Zeit. Elektrochem.* xx. 1914) have determined the vapour pressure of mercury at 20° C. by the quartz-fibre manometer and obtain a value 0.00126. At this temperature, Knudsen's formula would give the vapour pressure as 0.00119. As Haber's figure is the weighted mean of only two series of determinations (with values 0.00115 and 0.00130 respectively) it can hardly be asserted that Knudsen's values are too low, but it perhaps may be said that the true values are not lower than those given by the Knudsen formula.

$$\text{As } \lambda_T = RT^2 \frac{d \ln p}{dT},$$

and above 250° C.:

$$\log p = 9.9073436 - 0.6519904 \log T - \frac{3276.628}{T},$$

and below 150° C.:

$$\log p = 10.5724 - 0.847 \log T - \frac{3342.26}{T},$$

differentiating and multiplying by RT^2 ,

above 250° C.:

$$\lambda_T = 14976.35 - 1.2924 T,$$

and below 150° C.:

$$\lambda_T = 15277.46 - 1.6812 T.$$

Now, $\lambda_T = \lambda_0 + (C_p^g - c_p^l) T$, if c_p^g and C_p^g are constant.

The following graph gives the variation of c_p^l with temperature as determined by Naccari (*J. de Phys.* (2) viii. p. 612, 1889), by Barnes and Cooke (*Phys. Rev.* xvi. p. 65, 1903), and others.

The mean value at the lower temperatures is about 0.0331, so that $\lambda_T = \lambda_0 - (6.64 - 4.96) T = \lambda_0 - 1.68 T$, which agrees with the constant derived from the Knudsen vapour-pressure formula. Although the value of c_p^l decreases (to 140° C. according to Barnes), it does not do so sufficiently rapidly to account for the value 1.2942 in the equation for λ_T obtained from the Smith and Menzies formula, and it seems probable therefore that c_p^l can no longer be considered nearly constant.

Fig. 1.

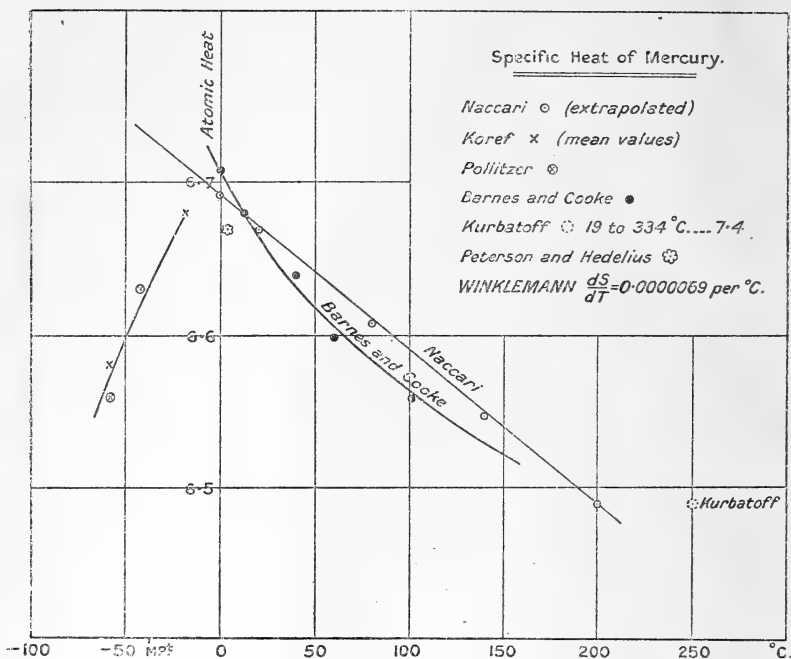

The following table is calculated from the above expressions for λ_T :—

TABLE II.

T.	Smith & Menzies.	Knudsen.
630	14161	14218
473	14364	14482
273	14623	14818
234.2	14673	14884

The molecular latent heat at the boiling-point has been measured directly by Kurbatoff (*Zeit. Physik. Chem.* xliii. p. 104, 1903), who found the value 13600 cal. This value is no doubt less accurate than that obtained as above. Konowaloff (*Zeit. Phys. Chem.* xxxix. 1887) also quotes Regnault, who obtained the value 15500; Traube (*Zeit. Chem.* xxxiv. p. 423, 1903) assumes the mean value 14540 cal. at 360° C.

Now,

$$\lambda_T = \lambda_0 + \int_0^T C_p dT - \int_0^T c_p^s dt - f_m - \int_{T_m}^T C_p^l dT ;$$

where C_p = atomic heat of vapour,

c_p^s = " " solid,

c_p^l = " " liquid,

f_m = latent heat of fusion at melting-point.

Whence

$$\lambda_0^s = \lambda_T^l - 4.963T + \left[\frac{U_m - U_0}{T_m} \right] T + f_m + c_p^l(T - T_m) + \frac{2}{5} a T^{5/2}$$

where $\left[\frac{U_m - U_0}{T_m} \right]$ can be obtained from the tables of the integration of Debye's formula for c_v^s (*Berl. Ber.* lii. p. 1176, 1912), a is the empirical constant for conversion of c_v to c_p , and c_p^l is considered to be constant.

In the case of mercury, from specific heat measurements (Koref, *Ann. d. Phys.* xxxvi. p. 64, 1911; and Pollitzer, *Zeit. Elektr. Chem.* xix. 1912), $\beta v = 97$; $\therefore \beta v / T_m = 0.4142$,

and $\frac{U_m - U_0}{T} = 5.083$.

$$f_m = 555 \text{ (Pollitzer)}$$

$$549 \text{ (Bridgman, Proc. Am. Acad. xlvii. p. 319 et seq., 1911)}$$

$$\text{Mean} = \underline{552}$$

* $a = 21 \cdot 10^{-5}$ (from Pollitzer's measurements of specific heat).

Thus

$$\begin{aligned} \lambda_0^s &= \lambda_T^l - 4.963T + c_p^l(T - T_m) + 1190.5 + 552 + 70.5 \\ &= \lambda_T^l - 4.963T + c_p^l(T - T_m) + 1813. \end{aligned}$$

* As the coefficient of expansion of the solid = 0.00014 at the melting-point (Bridgman, *l. c.*), and $v_m = 14.90$ (density 13.46, Bridgman, *l. c.*), and as $\frac{a^2 v T}{\kappa} = 21 \cdot 10^{-5} T^{3/2}$, the compressibility of the solid (κ)^s would be 2.17×10^{-6} per kg./cm.² (which lies between the values $1.66 \cdot 10^{-6}$ for zinc and $2.3 \cdot 10^{-6}$ for cadmium). The compressibility of the liquid at 0° C. is $3.90 \cdot 10^{-6}$ per kg./cm.², and the coefficient of expansion is 0.00018 and $v = 14.71$, whence a (liquid) would become $17.35 \cdot 10^{-5}$. $C_p^l - C_v^l$ has been determined at 0° C. by Bridgman = 0.805, whence a would be $17.85 \cdot 10^{-5}$.

Between $-35^{\circ}6$ and $-3^{\circ}4$ C. Koref found the mean $c_p^l = 6.68^*$; while between 0° and 200° C. the mean of Barnes and Cooke's and Naccari's results give $c_p^l = 6.58$.

From the values for λ_T given in Table II. the following values of λ_0 can be calculated :—

TABLE III.

T.	Smith & Menzies.	Knudsen.
630	15452	15509
473	15402	15520
273	15341	15536
234.2	15324	15535

Above 250° , the value of c_p is probably not constant; the values obtained from λ_{TB} will be neglected.

The values obtained from the Smith and Menzies formula vary more amongst each other than those of Knudsen, and therefore this formula probably does not express the true vapour pressure at the lower temperatures as well as the latter. The mean of these values, viz. 15530 ± 5 , obtained from the Knudsen formula will therefore be taken as most closely approaching the value for the latent heat of vaporization at absolute zero.

At the melting-point :—

$$\log p = -\frac{\lambda_0}{4.571 T_m} + 2.5 \log T_m + \frac{1}{4.571} \left[\frac{A_m - A_0}{T_m} \right] - \frac{4}{4.571 \cdot 15} a \cdot T_m^{3/2} + C$$

where

$$\lambda_0 = 15530 \quad \text{and} \quad -\frac{\lambda_0}{RT} = -14.507,$$

$$T_m = 234.2 \quad \text{and} \quad 2.5 \log T_m = 5.924,$$

$$\frac{A_m - A_0}{T_m} = -8.133 \quad \text{and} \quad \frac{1}{4.571} \left[\frac{A_m - A_0}{T_m} \right] = 1.779,$$

$$a = 21 \cdot 10^{-5} \quad \text{and} \quad \frac{4}{15} \cdot \frac{1}{4.571} \cdot a T_m^{3/2} = 0.0439.$$

$$p = 0.000001970 \text{ mm. and } \log p = -5.7055 \text{ mm.} \\ = -8.586 \text{ atmos.}$$

* This value is slightly low in comparison with that of other observers (see graph), and the average variation (Winkelmann) 0.0000069 per $^{\circ}$ C. would lead to a value about 6.73 , i. e. $\lambda_{T=273} = 15538$.

Knudsen gives the probable error of the values obtained from his vapour-pressure formula as $0.002 p$ between 0°C . and 15°C ., 0.007 up to 100°C . and 0.012 up to 200°C . The measurement at 0°C . is considered accurate to less than one part in one thousand. The temperature error was less than 0.15°C ., and the value obtained is in all probability not subject to any serious constant error. A confirmation of this figure for the vapour pressure at 0°C . by measurement with great precision would be valuable, as the chemical constant could then be obtained with certainty.

If the values at low temperatures are correct within $\pm 0.002 p$, and if the variation in specific heat is allowed for, then the value of the vapour pressure at the melting-point may vary between 2.00×10^{-6} and 1.95×10^{-6} . The latent heat of vaporization (λ_0) has been shown to be consistent within one part in 3000; the variations in vapour pressure and specific heat might lead to a result for $\lambda_0 = 15530 \pm 15$.

The value of $\beta\nu$ may vary within one per cent., so that the value of the specific-heat term may be 1.779 ± 0.01 .

The melting-point is certainly accurate within 0.1°C .

Hence, inserting in the formula the values obtained :

$$\begin{array}{r}
 +14\ 507 \pm 0.015 \quad -\ 5.924 \pm 0.002 \\
 +\ 1.823 \pm 0.01 \quad -\ 8.586 \pm 0.005 \\
 \hline
 16.330 \pm 0.025 \quad -14.510 \pm 0.007 \\
 -14.510 \pm 0.007 \\
 \hline
 C = 1.820 \pm 0.032
 \end{array}$$

Now $1.5 \log M = 3.453$, and if $1.5 \log M - C = -C_0$, a universal constant, then the value of this constant would be

$$C_0 = -1.633 \pm 0.032.$$

The value calculated from the constants h and k becomes $C_0 = -1.608$; so that the value determined is in complete agreement within the error* (see p. 19).

Now if $C_0 = 1.608$ the chemical constant for cadmium would be $3.076 - 1.608 = 1.468$, and that for zinc would be

* I find a calculation on similar lines to the above has already been published by Nernst, in his book 'Die Theoretischen und Experimentellen Grundlagen des Neuen Wärmesatzes' (1918), which leads to a value $C = 1.83 \pm 0.03$.

2.723—1.608=1.115. In a previous communication (Phil. Mag. xxxiii. p. 193, 1917) results were given of determinations at low pressures of the vapour pressures of solid cadmium and zinc. Although these results were not carried out with the precision necessary to obtain an accurate value for the chemical constants, it seems worth while to inquire whether the constants, deduced above, lie within the limiting values of the constants obtained from the observed results, taking into consideration the experimental errors.

Chemical Constant of Cadmium.

From the mean of the most reliable observations, the following two points are chosen, which lie on the smoothed curve of the vapour pressure :

$$T_1 = 471.8 \pm 1^\circ \text{ abs.}, \log p = -3.54(6) \pm 0.02.$$

$$T_2 = 532.5 \pm 1^\circ \text{ abs.}, \log p = -2.11(8) \pm 0.02.$$

From Lindemann's melting-point formula :

$$\nu = 3.1 \cdot 10^{12} \sqrt{\frac{T_m}{A\nu^{2/3}}}$$

where $T = 594^\circ \text{ abs.},$

$$A = 112.4,$$

$$\nu = 13.0 ;$$

$$\therefore \nu = 3.03 \cdot 10^{12}$$

and $\beta\nu = 147.5$

$$\therefore \frac{\beta\nu}{T_1} = \frac{147.5}{471.8} = 0.31262 ; \left[\frac{A_1 - A_0}{T_1} \right] = -9.592.$$

and $\frac{\beta\nu}{T_2} = \frac{147.5}{532.5} = 0.27700 ; \left[\frac{A_2 - A_0}{T_2} \right] = -10.239.$

Writing $aT^{3/2} = \frac{9\alpha^2\nu T}{\kappa}$, the value of a can be estimated for (say) 291° C.

$$\kappa = 2.25 \cdot 10^{-6} \text{ (mean of Gruneisen's and Richard's results),}$$

$$\alpha = 28.8 \cdot 10^{-6} \text{ (Matthiessen 1866) at } 20^\circ \text{ C.,}$$

$$\nu = 13.0.$$

$$\therefore a = \frac{9 \times (28.8)^2 \times 13.0 \times 291 \cdot 10^{-12}}{4.18 \times 2.3 \cdot 10^{-12} (291)^3} = 5.93 \cdot 10^{-5}.$$

This lies close to the value found for zinc.

The specific heat of cadmium has been measured between $17^{\circ}\cdot 1$ and $92^{\circ}\cdot 2$ C. by Gaede (*Phys. Z.S.* iv. p. 105, 1902); also between -186° and -79° by Behn (*Ann. d. Phys.* (4) i. p. 257, 1900)*. Employing Gaede's results,

$$c_p = 6\cdot 17 \text{ at } 290^{\circ}\cdot 1 \text{ abs.},$$

$$c_p = 6\cdot 36 \text{ at } 365^{\circ}\cdot 2 \text{ abs.}$$

From Nernst and Lindemann's formula, c_v can be calculated, viz.:

$$\frac{\beta\nu}{T_1} = \frac{147\cdot 5}{290\cdot 1} = 0\cdot 509; \quad c_v = 5\cdot 88,$$

$$\frac{\beta\nu}{T_2} = \frac{147\cdot 5}{365\cdot 2} = 9\cdot 404; \quad c_v = 5\cdot 91.$$

Putting $c_p = c_v + aT^{3/2}$,

$$a_1 = 5\cdot 87 \cdot 10^{-5}$$

$$a_2 = 6\cdot 44 \cdot 10^{-5}$$

$$\text{Mean . . . } a = 6\cdot 15 \cdot 10^{-5}$$

Having regard to the need of an approximate figure only, the value $6 \cdot 10^{-5}$ will be taken, which is approximately the mean between the values $5\cdot 93$ and $6\cdot 15$.

Inserting these values in the vapour-pressure formula (2), two equations are obtained from which $C = 1\cdot 65$.

By differentiation, it is found that a change of 2° in the temperature, which is the error in the temperature measurements, should lead to a change in the constant of $\pm 0\cdot 31$, so that the theoretical value $1\cdot 47$ lies within the experimental error $1\cdot 65 \pm 0\cdot 31$.

* Behn deduces from his mean values that

$$\text{at } 194^{\circ} \text{ abs. } C_p = 5\cdot 844 \quad (\therefore C_v = 5\cdot 682),$$

$$\text{at } 87^{\circ} \text{ abs. } C_p = 5\cdot 317 \quad (\therefore C_v = 5\cdot 268).$$

$\beta\nu$ in the first case would be 191 and in the second 138; it seems advisable therefore to take the value obtained from the melting-point formula: $147\cdot 5$.

The chemical constant of zinc can be obtained from the vapour-pressure measurements in a similar manner.

Taking the points :

$$\text{at } 553^\circ \text{ abs., } \log p = -3.35 \pm 0.02,$$

$$\text{at } 625^\circ \text{ abs., } \log p = -1.92 \pm 0.02.$$

The temperature measurements were considered to have a probable error $\pm 1^\circ \text{ C}$.

The value of $\beta\nu$ obtained from the melting-point formula is 234, and that from specific-heat measurements (Koref, *Ann. d. Phys.* xxxvi. 1911, and Pollitzer, *Z.S. f. Elek.* xvii. p. 5, 1911) is 235.

$$\text{At } \frac{\beta\nu}{T_1} = \frac{234}{553} = 0.42312 ; \quad \left[\frac{A - A_0}{T_1} \right] = -8.025,$$

$$\text{and } \frac{\beta\nu}{T_2} = \frac{234}{625} = 0.37440 ; \quad \left[\frac{A - A_0}{T_1} \right] = -8.650.$$

Pollitzer gives a from the specific-heat measurements as $5.4 \cdot 10^{-5}$.

From the coefficient of expansion $= 26 \times 10^{-6} \text{ cm.}$ (National Phys. Laboratory); compressibility $1.69 \cdot 10^{-12}$ per dyne/cm.², and atomic volume 9.22 c.c. , at temperature 291° abs. , a becomes $4.65 \cdot 10^{-5}$.

The value $5.4 \cdot 10^{-5}$ will be used.

Inserting these values for a , $\frac{A_m - A_0}{T_m}$, and p in the vapour-pressure formula, two equations are obtained, from which $C = 1.23$.

As before by differentiation, a change of temperature 2° C . will alter the constant ± 0.26 , so that the theoretical value 1.115 lies within the limits of experimental error.

Values of Chemical Constants.

Both for cadmium and zinc therefore, the result lies within the experimental error and there appears to be no doubt that the chemical constant may be represented by a formula $C_0 + 1.5 \log M$ as shown in the table.

TABLE IV.—Chemical Constants.

	Atomic weight.	Constant.	Probable error.	Constant (calc.).
Mercury.....	200.6	1.820	± 0.032	1.845
Cadmium ...	112.4	1.65	± 0.31	1.468
Zinc	65.37	1.23	± 0.26	1.115

Nernst (*l. c.*) has calculated the constant in two other cases :—

	Atomic weight.	Constant.	Probable error.	Constant (calc.).
A	39·88	0·75	±0·06	0·893
H ₂	2·016	-1·23	±0·15	-1·151

The value of C₀ obtained from all the experimental results and from the probable errors, giving due weight to the observations, is as follows :—

	-C ₀ (obs.)	Weight.
Mercury . . .	1·633	1·0
Cadmium . . .	1·42	0·10
Zinc . . .	1·49	0·12
Argon . . .	1·65	0·53
Hydrogen . . .	1·68	0·21

$$C_0 \text{ mean} = \frac{3\cdot180}{1\cdot96} = -1\cdot622 \quad \text{1·96}$$

This value is slightly higher than the calculated (1·608), but agrees within ·85 per cent.

Latent Heats of Vaporization.

In the paper on the vapour pressure of mercury, cadmium, and zinc already cited, values of λ₀ were given from the relation :

$$p = KT^{-\frac{1}{2}} e^{-\frac{\lambda_0}{RT}},$$

which was found to agree well with the observed results.

Here $\log p = \log K - \frac{1}{2} \log T - \frac{\lambda_0}{RT}$ and it is assumed ($C_p - c_p$) remains constant and equal to unity. This will be approximately the case at ordinary temperatures where $C_p = 2\cdot5R$ and $c_p = 3R$. It follows $\lambda_T = \lambda_0 - T$, as an approximation. The values of λ₀ have now also been obtained from the rational vapour-pressure formula :

$$\log p = -\frac{\lambda_0}{RT} + \int_0^T \frac{dT}{RT^2} \int_0^T C_p dT - \int_0^T \frac{dT}{RT^2} \int_0^T c_p dT + C,$$

which may also be expressed :

$$p = KT^{2\cdot5} e^{-\frac{\lambda_0 + f(T)}{RT}},$$

where $f(T)$ is a function depending on the change of atomic heat of the solid.

If the formula $\lambda_T = \lambda_0 + 4.963T - \int_0^T c_p^s dT - \frac{2}{5} aT^{5/2} \dots$ is differentiated, it will be seen λ is not necessarily a maximum at the absolute zero :

$$\frac{d\lambda_T}{dT} = 4.963 - (c_p^s + aT^{3/2}),$$

which becomes a maximum when

$$c_p^s = 4.963, \quad i. e. \quad \beta\nu/T = 1.95.$$

For mercury, $\beta\nu/T = 97/1.95 = 49^\circ.7$ abs.

„ cadmium, $\beta\nu/T = 147/1.95 = 75^\circ.5$ abs.

„ zinc, $\beta\nu/T = 234/1.95 = 120^\circ.0$ abs.

In order to deduce the above results, the theoretical value of the chemical constant is assumed and the same vapour-pressure measurements are employed, thus for zinc :

$$\begin{aligned} \lambda_0 &= 1.92 + 2.881 + 2.5 \log 625 - \frac{8.650}{4.571} - 0.0583 \\ &\quad \times 5.4 \cdot 10^{-5} \cdot 625 + 1.115 \pm 0.26 \\ &= \underline{31330 + 750}. \end{aligned}$$

$$\begin{aligned} \lambda_{M.Pt.} &= 31330 + 4.963 \cdot 691 - 5.235 \cdot 691 - 2/5 \cdot a \cdot (691)^{5/2} \\ &= \underline{30871}. \end{aligned}$$

$$\begin{aligned} \lambda_{max.} &= 31330 + 4.963 \cdot 120 - 120 \cdot 2.684 - 2/5 \cdot a \cdot (120)^{5/2} \\ &= \underline{31570}. \end{aligned}$$

The values in the last column of the following table are calculated from Nernst's relation :

$$\lambda_0 = T_B 8.5 \log T_B.$$

They agree closely with the values deduced from the vapour pressure*.

The values for λ_0 , $\lambda_{max.}$, and $\lambda_{M.Pt.}$ are given in the table below.

* It may be noted that Nernst's other empirical expression,

$$\lambda_B = 9.5 \log T_B - 0.007 T_B,$$

does not agree nearly so well. It is obvious it is not applicable to high temperatures.

TABLE V.

	λ_0 .	λ_{\max} .	$\lambda_{M.Pt}$.	$\lambda_{B.Pt}$.	$\lambda_{\text{calc.}}$
Mercury.....	15530± 15	15646	14884	14161	14900
Cadmium ...	26770±750	26941	26292	—	26900
Zinc	31330±750	31570	30871	—	31200

Constants of other Metals.

Measurements of the vapour pressure of other monatomic substances which have been made do not lend themselves readily to a calculation of the constant, as most of them would involve a knowledge of the specific heat of the molten metal.

Langmuir and Mackay (*Phys. Zeit.* xiv. p. 1273, 1913, and *Phys. Rev.* 4, ii. p. 377, 1914) have, however, investigated the vapour pressure of solid tungsten, platinum, and molybdenum by measurement of the loss of weight of a heated filament *in vacuo*. Using a vapour-pressure formula of the Hertz type, the results are expressed :

Tungsten, $\log p(\text{mm.}) = 15.502 - 47440/T - 0.9 \log T$.

Molybdenum, $\log p = 17.354 - 38600/T - 1.26 \log T$.

Platinum, $\log p = 14.09 - 27800/T - 1.26 \log T$.

By differentiation,

Tungsten, $= 216850 - 1.79 T$.

Molybdenum, $= 177000 - 2.5 T$.

Platinum, $= 128000 - 2.5 T$.

In the latter cases, if $(c_p - C_p)$ is constant throughout the temperature scale to T° absolute, then the constants 177000 etc. will represent the value of λ_0 ; and as $C_p = 4.963$, c_p is taken as 7.64 in the last two cases and as 6.75 in the case of tungsten. Langmuir and Mackay have applied their results to the formula :

$$\log p = -\frac{\lambda_0}{4.571T} + 1.75 \log T - \frac{\epsilon}{4.571} T + C,$$

and have obtained values for the constants as follows :—

Tungsten 3.5

Platinum 1.5

Molybdenum 4.4

In the case of tungsten, they have assumed a greater atomic heat than given above, about 7.5, which changes the value of λ_0 to 218000.

This is in better accordance with the observations of Corbino (*Atti R. Accad. Lincei*, 1912, xxi. pp. 346 & 188), who finds a value for $C_v = 7.8$, which remains fairly constant over a wide range of temperatures (2000° C.)*.

It has already been pointed out that calculation of the constants in the above way leads to results without physical significance, but the knowledge of the change of specific heat at high temperature is insufficient to permit of the rational method providing a reliable value for the constants of these metals.

In the case of tungsten, from the melting-point formula $\beta\nu$ may be taken as 301.

At 2400° abs.,

$$\frac{\beta\nu}{T} = 0.125 \quad \text{and} \quad \frac{A_T - A_0}{T} = 14.648 \quad \text{and} \quad \frac{14.648}{4.571} = 3.2041.$$

$$a = \frac{9\alpha^2 v}{\kappa T^{\frac{3}{2}}} = \frac{121 \cdot 9 \cdot 7 \cdot 290}{0.275 \cdot 4 \cdot 18 \cdot T^{\frac{3}{2}}} = 0.6 \cdot 10^{-5} \quad \text{and} \quad 0.0583 a T^{3/2} = 0.0411.$$

$$p = 5.0 \cdot 10^{-8}; \quad \log p = -10.182 \text{ atmos.}$$

$$\text{and} \quad \frac{\lambda_0}{4.571 T} = -\frac{218000}{4.571 \cdot 2400} = -19.872;$$

so that

$$C = -10.182 + 19.872 - 8.450 + 3.204 + 0.041.$$

$$\therefore C = 4.48.$$

For platinum, $\beta\nu$ has been measured from the specific heat and has a value 220. From the melting-point, the value 223 has been calculated. Taking $\beta\nu = 220$,

$$\frac{\beta\nu}{2000} = 0.11 \quad \text{and} \quad \frac{A_T - A_0}{T} = 15.372 \quad \text{and} \quad \frac{15.372}{4.571} = 3.363,$$

$$3a = 27 \cdot 10^{-6} \quad (\text{see Nernst, } Z.S. f. Elektrochem. xvii. \text{ p. 819, 1911}),$$

$$v = 9.1,$$

$$\kappa = 0.40 \cdot 10^{-12};$$

* For platinum some measurements of c_p have also been made at high temperatures. Konigsberger (*Verh. d. Phys. Ges.* xiv. pp. 275, 540, 1912) gives the following figures:—

$$\begin{array}{lll} 773^\circ & c_p = 6.57, & c_v = 6.56; \\ 1173^\circ & c_p = 7.39, & c_v = 6.79. \end{array}$$

whence $a = 2.32 \cdot 10^{-5}$ (at 290° abs.).

At 473° , Konigsberger (*l. c.*) gives $\frac{9a^2vT}{\kappa} = 0.207$, so that

$$a = 2.01 \cdot 10^{-5},$$

$$\lambda_0 = 128000 \text{ and } -\frac{\lambda_0}{4.571T} = -14.000,$$

$$p = 0.0001072 \text{ at } 2000^\circ \text{ C.} = -6.851 \text{ atmos.}$$

Inserting these values, as in the above calculation, C becomes 2.36.

Apart from the uncertainty in the value for λ_0 owing to the change in the specific heat, it appears that further experimental work is required before these measurements of the vapour pressures at high temperatures can be used for evaluating the chemical constants of these metals.

Determination of Stephan's Constant.

Professor Lindemann, to whom I am indebted for his kindly advice and assistance and the interest he has taken in this work, has suggested to me that a value for one of the radiation constants might be obtained from the chemical

constant. Thus, Stephan's constant $\sigma = \frac{2}{15} \pi^5 \frac{R}{N^4 c^2 h^3}$,

and $\log_{10} \frac{(2\pi)^{3/2} \cdot K^{5/2}}{N^{3/2} \cdot h^3} = C_0 + 6.0056$ (C.G.S.).

$$\therefore \log_{10} \sigma = C_0 - \log_{10} \frac{15\sqrt{2}}{\pi^{7/2}} \cdot \frac{c^2}{R^{3/2}} + 6.0056.$$

Substituting values:

$$R = 8.306 \cdot 10^7,$$

$$c = 2.9986 \cdot 10^{10},$$

$$\log_{10} \sigma = C_0 - 2.6563 + 6.0056.$$

If $C_0 = -1.622$ (see p. 15)

$$\sigma = 5.27 \cdot 10^{-5} \text{ erg} \cdot \text{cm}^{-2} \cdot \text{deg}^{-4}.$$

If the value obtained from mercury, only, is employed, viz. 1.633 ± 0.032 :

$$\sigma = 5.16 \cdot 10^{-5} \pm 0.37.$$

* If $R = 8.306 \cdot 10^7$, $N = 6.062 \cdot 10^{23}$, $h = 6.57 \cdot 10^{-27}$. Substituting in $C_0 = \frac{(2\pi)^{3/2} R^{5/2}}{N^4 h^3} = -1.593$, this theoretical figure, used to determine σ , would give $5.64 \cdot 10^{-5}$, but this value is dependent on other determinations of h and N . The value -1.608 (which has been used) is due to slightly different values of the constants.

Thus, the value deduced from the experiments is nearer the older value (as given by Planck, *Vorlesungen über die Theorie der Wärmestrahlung*) $5.3 \cdot 10^{-5}$, rather than the newer values which have been obtained more recently, e. g. Gerlach (*Ann. d. Phys.* 50. 3, p. 259, 1916) $5.9 \cdot 10^{-12}$ watt. cm.⁻² . deg⁻⁴.

Summary.

Methods of calculating the chemical constant and the conditions necessary for obtaining accurate results are discussed. It is shown that the older formula by which most of the constants were calculated leads to a result without physical significance. The formula which should be used requires a knowledge of the specific heat of the substance (*i. e.* of the value $\beta\nu$).

The chemical constant of mercury is calculated and the accuracy of the result is discussed. The constant is found to be 1.820 ± 0.032 .

This value leads to a value for C_0 , the universal constant of the theoretical relation $-C_0 = C - 1.5 \log M$, within the experimental error.

The chemical constants C of cadmium and zinc are evaluated from the vapour-pressure measurements (*Phil. Mag.* vol. xxxiii. p. 193, 1917), and the values calculated using the theoretical value of C_0 are found to lie within the experimental error.

The value of C_0 for monatomic substances, the mean of all values so far determined, is found to be -1.622 .

The latent heats of vaporization of zinc, cadmium, and mercury are given for various temperatures, and the maximum value is found for all monatomic substances at a temperature $\frac{\beta\nu}{T} = 1.95$.

There appears to be need for further experiment before the data obtained by Langmuir and Mackay for the vapour pressures of tungsten, molybdenum, and platinum at high temperatures can be used for accurate determinations of their chemical constants.

Stephan's constant for full radiation σ has been deduced from the mean value of the constant C_0 and is given as $5.27 \cdot 10^{-5}$ erg. cm.⁻² . deg⁻⁴. This value appears to be definitely lower than the more recently determined values, within the experimental error, and is dependent only on the vapour pressure, specific heat of mercury, gas constant, and velocity of light.

Clarendon Laboratory, Oxford.
Sept. 1st, 1919.

II. *Note on the Significance of the Chemical Constant and its Relation to the Behaviour of Gases at Low Temperatures.*
 By F. A. LINDEMANN, *Professor of Experimental Philosophy, Oxford* *.

THE general equation for the vapour pressure of a solid, derived by integrating the Clausius-Clapeyron equation, is of the form

$$\log p = \int^T \frac{\lambda}{RT^2} dT + C = \int^T \frac{\lambda_0 - \int_0^T c_p dT + \int_0^T C_p dT}{RT^2} dT + C.$$

Here λ is the latent heat, λ_0 the same at the absolute zero, c_p and C_p the molecular heats of solid and gas at constant pressure, R the gas constant and C the chemical constant.

The object of this note is to examine the question of the dimensions of C somewhat more in detail than is usually done, since it may be shown that this question is intimately bound up with the problem of the degradation of perfect gases. As will appear, the evidence of the chemical constants seems to be against the degradation theory if the above equation is accepted, and, moreover, the physical significance of the chemical constant appears in quite a new light when examined on these lines.

In the text-books two different statements are found, namely, that the chemical constant has the dimensions of the logarithm of a pressure, *e. g.* Jellinek, *Phys. Chem. d. Gasreaktionen*, p. 765, or that it has the dimensions of the logarithm of a pressure divided by a temperature to the power 5/2, *e. g.* Lewis, 'System of Physical Chemistry,' vol. iii. p. 190. The first statement, which at first sight appears to be justified by the fact that $\frac{\lambda}{RT^2} dT$ is a pure

number, really entails the assumption that the atomic heat of the gas becomes equal to that of the solid at the absolute zero. The second view is arrived at by assuming the gas laws to hold down to the lowest temperatures. The question may be stated generally as follows. If c_p and C_p are analytic functions of T one may write

$$\int_0^T c_p dT = a_0 + a_1 T + a_2 T^2 + \dots$$

and

$$\int_0^T C_p dT = b_0 + b_1 T + b_2 T^2 + \dots$$

* Communicated by the Author.

Hence $\log p =$

$$\frac{\lambda_0}{RT} - \frac{b_0 - a_0}{RT} + \frac{b_1 - a_1}{R} \log T + \frac{b_2 - a_2}{R} T + \dots$$

It is clear that every term of this series is a pure number with the exception of the third, which has the dimensions of the logarithm of a temperature to the power $\frac{b_1 - a_1}{R}$. One must conclude, therefore, that the dimensions of C are those of the logarithm of a pressure divided by a temperature to the power $\frac{b_1 - a_1}{R}$.

Now b_1 and a_1 are clearly the atomic heats of the gas and the solid at the absolute zero, and there seems little doubt that a_1 , and for that matter a_2 and a_3 , are zero. Therefore, if the value of $b_1 - a_1$ can be found it will be a measure of the atomic heat of the gas at the absolute zero.

Assuming the chemical constant C to depend only on m , the mass of the atom, k , Boltzmann's constant R/N , and h , Planck's constant, a simple dimensional consideration shows that it must be of the form

$$\log \frac{m^{3/2} k^{5/2}}{h^3} \theta^{5/2 - \frac{b_1 - a_1}{R}}$$

Therefore it must be possible to represent it by an expression of the form

$$C = K + 3/2 \log A + (5/2 - b_1/R + a_1/R) \log \theta,$$

where K is a constant, A the atomic weight, and θ some unknown temperature which can only depend upon the temperature at which according to the "degradation" theories the gas laws cease to hold.

Unless θ is equal for all elements*, and this is scarcely conceivable in the case of substances of such divergent characteristics as say mercury and argon or cadmium and hydrogen, a study of C should enable one to form some idea of the value of b_1 since $a_1 = 0$. Now it has been shown that C may be represented within the limits of error by

$$C = K + 3/2 \log A.$$

* This assumption was made in the case of isotopes in a recent paper (Phil. Mag. xxxvii. 1919, p. 523). It is readily seen that the question there considered, *i. e.*, the difference of the chemical constants of isotopes, is unaffected by which of these views is taken.

Therefore, unless θ by some curious coincidence is very nearly 1° for all the elements examined, one must conclude that $b_1 = 5/2R$. This, of course, is the usual value for the atomic heat of a monatomic gas at constant pressure and precisely what the classical, as opposed to the "degradation," theory would lead one to expect.

The following table derived from figures kindly placed at my disposal by Mr. A. C. G. Egerton indicates the value of the experimental evidence. If $C_p = 5/2R$ the column headed θ should be equal to 1° . If C_p is to become zero near the absolute zero, one must assume that θ has the values given in column 3, *i. e.* that it happens to be very nearly 1° in all these substances.

	C.	$C - 3/2 \log A.$	$\theta.$
Hg	1.820 ± 0.052	-1.633 ± 0.032	0.976 ± 0.030
Cd	1.65 ± 0.31	-1.42 ± 0.31	1.19 ± 0.40
Zn	1.23 ± 0.20	-1.79 ± 0.26	1.11 ± 0.30
Ar	0.75 ± 0.06	-1.65 ± 0.06	0.962 ± 0.06
H ₂	-1.23 ± 0.15	-1.68 ± 0.15	0.935 ± 0.14

It is evident that the more accurate the determination the more closely does θ approach 1° . It is always 1° within the limits of experimental error, and it seems most improbable that this approach to the purely conventional unit of the scale on which the temperature is measured should be a mere coincidence. It is true that the equation $p_v = RT$ is used in deriving Clapeyron's equation and that a different formula would be obtained if the degradation equation were used. It seems unlikely though that this would compensate in such a way as to invalidate the above argument. If not, one must conclude that $C_p = 5/2R$ even at the lowest temperatures and give up the degradation theories, which make it become zero.

This may be more acceptable if a further simplification is considered which puts the physical significance of the chemical constant in a somewhat different light. If the vapour pressure is written

$$p = p_0 T^{5/2} e^{\int_0^T \frac{\lambda_0 - f(T)}{RT^2} dT},$$

where $f(T) = \int_0^T c_p dT$, one must put

$$p_0 = \frac{(2\pi)^{3/2} m^{3/2} k^{5/2}}{h^3},$$

the value $(2\pi)^{3/2}$ being that derived by Sackur, Tetrode, Nernst and others. Since Stephan's constant

$$\sigma = \frac{2\pi^5}{15} \frac{l^4}{c^2 h^3},$$

one may therefore write, as $mv^2 = 3kT$ in a monatomic gas,

$$p = \frac{45 \sqrt{6\pi}}{\pi^4} \frac{c^3 \sigma T^4}{v^3 c} e^{\int_0^T \frac{\lambda_0 - f(T)}{RT^2} dT}.$$

Now $\frac{4\sigma T^4}{3c} = P$ is the radiation pressure of complete radiation of temperature T on the walls of a containing vessel, so that the vapour pressure

$$p = \frac{135 \sqrt{6\pi}}{4\pi^4} \frac{c^3}{v^3} P e^{\int_0^T \frac{\lambda_0 - f(T)}{RT^2} dT},$$

where v is the velocity of the molecules in the gas.

If the velocity of sound $V = v \sqrt{\frac{\gamma}{3}} = \frac{v}{3} \sqrt{5}$ is introduced this becomes

$$\begin{aligned} p &= \frac{25 \sqrt{30\pi}}{4\pi^4} \frac{c^3}{V^3} P e^{\int_0^T \frac{\lambda_0 - f(T)}{RT^2} dT} \\ &= 0.623 \frac{c^3}{V^3} P e^{-\frac{\lambda_0}{RT}} \end{aligned}$$

at low temperatures at which $f(T)$ is small. If any frequency ν is considered, the wave-length of the elastic wave in the gas is $\frac{V}{\nu}$ and of the corresponding electromagnetic wave $\frac{c}{\nu}$.

Therefore the energy residing in the gas in a cube whose side is one wave-length divided by the corresponding energy in

the radiation is $1.246 e^{-\frac{\lambda_0}{RT}}$, *i.e.* 1.246 times the fraction of molecules whose energy is greater than the potential energy acquired when they are removed from the solid to infinity. This relation is strongly reminiscent of a well-known theorem in the theory of radiation, namely, that complete radiation is in equilibrium in any two dielectrics when the energy in a wave-length cube in one, is equal to the energy in a wave-length cube of the same frequency in the other. In comparing the energy in the gas to that in the radiation at reasonably low temperatures the corresponding theorem would be, that radiation pressure is in equilibrium with vapour pressure when the energy per molecule capable of

evaporating in a wave-length cube residing in the gas is equal to $\frac{25 \sqrt{30\pi}}{2\pi^4} = 1.246$ times the energy residing in a cube of radiation of corresponding wave-length. One may conclude therefore, since the chemical constant can be replaced by radiation pressure, that its physical significance may perhaps be sought rather in the interaction of radiation and matter than in the subdivision of Gibbs's N dimensional space into finite elements of equal probability.

If these finite cells of equal probability really exist it would seem difficult to escape the conclusion that the atomic heat disappears near the absolute zero. The evidence appears to be against this as was shown above, and one of the strongest arguments in favour of such a revolutionary assumption would seem to have been removed if the value of the chemical constant can be derived from the radiation pressure. The law of complete radiation cannot be deduced without some quantum assumption of course, but it would be a considerable simplification if it could be avoided in gases.

Summary.

It is shown that the chemical constant has the dimensions of the logarithm of a pressure if the atomic heat of monatomic gases becomes zero at the absolute zero. In this case it should be of the form $K + 3/2 \log A + 5/2 \log \theta$, where θ is a characteristic constant of the substance.

It is shown that it has the dimensions of the logarithm of a pressure divided by a temperature to the power $5/2$ if the atomic heat of a monatomic gas remains $5/2 R$ down to the absolute zero. In this case it should be of the form $K + 3/2 \log A$.

Experimental determinations show that the latter form is true within the limits of error. It follows either that θ is very nearly equal to 1° for all substances, which seems improbable, or that the atomic heat remains constant down to the lowest temperatures.

It is further shown that the chemical constant may be eliminated and the vapour pressure expressed in terms of the pressure of complete radiation. It is therefore suggested that the chemical constant may express the interaction of matter and complete radiation rather than requiring that a gas can assume only a finite number of possible microphases at given temperature, pressure, and volume.

III. *An Unsolved Problem in the Application of the Quantum Theory to Chemical Reactions.* By W. C. M. LEWIS, Professor of Physical Chemistry, University of Liverpool*.

IN a series of papers, entitled "Studies in Catalysis," published during the last few years in the Journ. Chem. Soc., I have attempted to apply the quantum theory to the problem of chemical kinetics, the fundamental concept being that the thermal radiation in equilibrium with the material system is the source of the energy required to bring about chemical change, and further, that the rate at which a reaction proceeds depends directly upon the density of the radiation of the absorbable type or frequency. By making use of Planck's expression for radiation density, a number of results have been obtained which are in good agreement with experiment. Notably one obtains on this basis an expression for the effect of temperature upon the velocity constant of a reaction which is in good agreement with the empirical equation of Arrhenius, and is also in agreement with the statistical equation of Marcelin and Rice, namely

$$d \log k/dT = E/RT^2,$$

where k is the velocity constant, and E is the critical increment reckoned per grammolecule of the decomposing substance. E represents the additional energy which must be given to a molecule (by the absorption of radiation) in order to render the molecule reactive, for, as finite velocities show, molecules possessing the average amount of internal energy are not chemically reactive. Similar conclusions have been reached independently by Perrin (*cf.* 'Atoms'; also "Matière et Lumière," *Annales de Physique* [xi.] xi. 1919).

Further, it has been found possible to calculate the velocity constant of a *bimolecular* reaction in the gaseous state in absolute measure, on the above assumptions, viz. (1) that radiation of suitable frequency must be absorbed in order to activate the molecule chemically, (2) that one quantum of such radiation is required per molecule (Einstein's law), and (3) that when a collision occurs between two molecules thus activated then and only then does the bimolecular reaction take place (*cf.* Lewis, *Trans. Chem. Soc.* cxiii. p. 471, 1918). It is found that numbers thus calculated for the velocity constant are in good agreement with those found by experiment.

Having attained a certain measure of success in the case

* Communicated by the Author.

of bimolecular reactions, the attempt was made to work out an expression for the velocity constant of a *unimolecular* reaction, based on the quantum theory. It should be observed that there is a fundamental difference between a unimolecular and a multimolecular reaction, in that a unimolecular reaction represents a spontaneous process independent of collisions with other molecules. The rate at which such a process occurs must in fact be determined wholly by the rate at which radiation of the absorbable type can be absorbed. Let us consider a simple case, namely, the dissociation of the gas AB into A and B. By the term unimolecular velocity constant is meant the proportionality factor which occurs in the expression :

$$dC/dt = kC,$$

or

$$k = \frac{1}{t} \log \frac{C_0}{C},$$

where C is the concentration of the gas, C₀ its initial concentration, and t is time expressed in seconds.

On applying the radiation hypothesis to such a process, it follows that the velocity constant k₀ (which stands for the amount of material decomposed per second, expressed as a fraction of the concentration unit, when the material is itself at unit concentration) should be obtained by dividing the rate of absorption of radiation of frequency ν by the quantity hν, the latter being the amount of energy required to decompose the molecule of AB.

From the standpoint of the physicist the chief interest of the problem lies in the fact that quite different results are obtained, according as we assume the radiation absorption to be continuous (Planck) or discontinuous (Einstein).

First of all let us assume that the absorption is continuous. On this basis Planck has shown that the amount of energy absorbed by a single oscillator or molecule per second is

$$\frac{\pi e^2}{3m} u_\nu,$$

where e and m are the charge and mass of an electron, and u_ν is given by

$$u_\nu = \frac{8\pi h n^3 \nu^3}{c^3} \cdot e^{-h\nu/kT}.$$

The simple exponential form is justifiable, as the wavelengths which are known to be responsible for chemical changes are sufficiently short. c is the velocity of light in

vacuo, ν the frequency of the radiation causing the chemical change, and n the refractive index, which, for gaseous systems, we shall take as unity.

If there are N molecules of AB present in the system considered, the total amount of energy of frequency ν absorbed per second is then

$$\frac{8\pi^2 e^2 h \nu^3}{3mc^3} \cdot e^{-h\nu/kT} \times N.$$

Further, since $h\nu$ is the quantity required to decompose a single molecule, it follows that the number of molecules decomposed per second in the system is

$$\frac{8\pi^2 e^2 \nu^2}{3mc^3} \cdot e^{-h\nu/kT} \times N.$$

This is simply the rate of the unimolecular reaction, which is ordinarily expressed :

$$dN/dt = k_0 N,$$

where k_0 is the unimolecular velocity constant.

It follows therefore that

$$k_0 = \frac{8\pi^2 e^2 \nu^2}{3mc^3} \cdot e^{-h\nu/kT}.$$

On substituting numerical values for the constants in this expression we find :

$$k_0 = 2.465 \times 10^{-22} \times \nu^2 \times e^{-h\nu/kT}. \quad \dots (1)$$

We have now to compare this result with experiment. The reaction considered is the unimolecular decomposition of phosphine gas, which has been recently investigated by Trautz and Bhandarkar (*Zeitsch. anorg. Chem.* cvi. p. 95, 1919) over a considerable range of temperature. From the observed velocity constants at different temperatures in the region 940° to 953° absolute, it is found that the critical increment E per grammolecule lies somewhere between 70,000 and 80,000 calories. We shall not be making any serious error if we take the mean value to be 75,000 cal. We then have :

$$N_0 h \nu = 75000,$$

where $N_0 = 6.1 \times 10^{23}$. It follows that

$$\nu = 8 \times 10^{14} \text{ (or } \lambda = 375 \mu\mu\text{)}.$$

At the temperature 945 abs. the exponential term

$$e^{-h\nu/kT} = 4.37 \times 10^{-18},$$

so that finally

$$k_0 = 2.465 \times 10^{-22} \times 64 \times 10^{28} \times 4.37 \times 10^{-18},$$

$$\text{or} \quad k_0 = 6.9 \times 10^{-10}.$$

The value of k_0 found by experiment = 10.2×10^{-3} .

The observed value is therefore 10^7 times the calculated value.

It may be mentioned that discrepancies of the same order of magnitude are found in other cases, such as the dissociation of iodine gas, but in these cases the value of k_0 used for comparison was not directly observed, and consequently, for the purposes of the present argument, less stress could be laid upon the discrepancy.

In view of the above results it is necessary to try to account for the experimental velocity constant on the basis of the discontinuous view of absorption, that is, upon the assumption that radiant energy exists in small units or quanta, a view which appears to be indistinguishable from a corpuscular one. Unfortunately, in making this attempt numerical values have to be ascribed to certain quantities about which there is necessarily a very large measure of doubt. The chief of these is the dimensions to be ascribed to the quantum itself. Since an electron is capable of picking up a quantum in the act of absorption, I have assumed that the quantum itself possesses dimensions of the same order of magnitude as an electron, that is, the "radius of a quantum" is 2×10^{-13} cm., corresponding to the value of the radius of an electron recently given by Jeans (*Trans. Chem. Soc.* cxv. p. 866, 1919). As a matter of fact, the final conclusion arrived at would not be altered by ascribing to a quantum the dimensions of a molecule (10^{-8} cm.).

When a quantum and a molecule collide with one another, absorption is regarded as occurring and the molecule decomposes. On this basis we treat the problem as we would treat the collisions between molecules in a bimolecular reaction. In the case of a molecular system the number of collisions per second is given by the expression:

$$\pi \cdot \sigma_1 \sigma_2 \sqrt{u_1^2 + u_2^2} N_1 N_2,$$

in which σ_1 and σ_2 are the molecular radii, u_1 and u_2 the root-mean-square velocities of the molecules of which there are N_1 and N_2 present per unit volume. In the analogous case we can let σ_1 and N_1 refer to the molecules and σ_2 and N_2 refer to the quanta. The velocity term becomes simply c ,

the velocity of light, since molecular speed may be neglected in comparison. The rate of the reaction is then given by

$$dN_1/dt = \pi \sigma_1 \sigma_2 c N_1 N_2,$$

or the unimolecular velocity constant is given by

$$k_0 = \pi \sigma_1 \sigma_2 c N_2.$$

We have now to evaluate N_2 , the number of quanta per c.c., N_2 being a constant throughout the reaction, as long, in fact, as the temperature is maintained constant.

Obviously the number of quanta of frequency ν in one c.c. is obtained by dividing the radiation density $u_\nu d\nu$ by the quantity $h\nu$. That is,

$$k_0 = \pi \sigma_1 \sigma_2 c \cdot \frac{8\pi\nu^2}{c^3} \cdot e^{-h\nu/kT} \cdot d\nu.$$

Setting $\sigma_1 = 2 \times 10^{-8}$ cm., and $\sigma_2 = 2 \times 10^{-13}$ cm., we have

$$k_0 = 3.4 \times 10^{-40} \cdot \nu^2 \cdot e^{-h\nu/kT} \cdot d\nu. \quad (2)$$

The term $d\nu$ corresponds to the width of the band at the frequency ν . Certain estimates of the limiting value of $d\lambda$, to which a physical significance can be attributed, are given by Schuster ('Theory of Optics,' 2nd ed. p. 346), from which it appears that the limiting value of $d\lambda$ is approximately 10^{-12} cm. In the case of phosphine, where λ itself occurs at approximately $375 \mu\mu$, it follows that $d\nu = -\nu \frac{d\lambda}{\lambda}$ is of the order 10^7 . If we give an excessively large value to $d\lambda$ by setting it equal to $100 \mu\mu$, we find $d\nu$ to be of the order 10^{14} . Even employing this large value, it is evident that equation (2) will give rise to a far smaller value for k_0 than does equation (1). The discrepancy between the observed and calculated velocity constant is therefore still greater on the discontinuous view of absorption than it is on the continuous view.

We are forced back therefore, I think, to the continuous view of absorption as being the more hopeful of the two in spite of the great discrepancy which still exists. The problem which awaits solution is to account for the discrepancy factor, which, rather remarkably, seems to be about the same quantity for different gaseous reactions, and further, is apparently independent of temperature. The mean value of this factor is approx. 4×10^7 , this being the quantity by which the right-hand expression in equation (1) must be multiplied in order to arrive at a result in agreement with experiment. The discovery of the cause of this discrepancy would be a very great advance in chemical kinetics. It looks as though some modification of Planck's expression for

the rate of absorption of radiation would be necessary. Possibly some physicist, better qualified than the writer to deal with the fundamental basis of the quantum theory, might interest himself in this problem, a problem of very great chemical importance.

In concluding, attention may be very briefly drawn to an empirical expression already employed by the writer in connexion with unimolecular reactions in gases, which seems to account fairly well for the velocity constant in such processes (*cf.* Lewis, *loc. cit.*). The expression is :

$$k_0 = 10^3 p^2 u_\nu = \frac{1.6 \times 10^{59}}{\nu^3} e^{-h\nu/kT},$$

where $p = c^3/8\pi hn^3 \nu^3$ (the definition of Planck),

and u_ν has its usual significance. Applying this expression to the case of the decomposition of phosphine at $T=945$, taking $\nu = 8 \times 10^{14}$ as before, it is found that

$$k_0 \text{ calc.} = 1.36 \times 10^{-3},$$

$$\text{whilst } k_0 \text{ obs.} = 10.2 \times 10^{-3}.$$

The observed value is about eight times the calculated. The discrepancy is now small and might even be accounted for by a relatively small change in the value taken for the characteristic frequency. Whether the above empirical expression has any theoretical significance the writer is unable to decide.

Summary.

1. On applying the quantum theory to a unimolecular chemical reaction, it is shown that very different results are obtained according as we assume the continuous or discontinuous view of the absorption of radiation.

2. On comparing the calculated with the observed velocity constant, it is shown that a very large discrepancy exists between the two values, the discrepancy being much greater, however, on the discontinuous view than it is upon the continuous.

3. The discrepancy referred to in (2) is always in the sense that the observed velocity constant is many times greater than the calculated. The discrepancy factor (on the continuous view) is of the order 10^7 , and appears to be of the same order of magnitude for different reactions. It also appears to be independent of the temperature.

4. The explanation of this discrepancy would constitute an exceedingly important contribution to the theory of physico-chemical processes.

Muspratt Laboratory,
University of Liverpool.

IV. *Latent Heat and Surface Energy.*—Part II. By D. L. HAMMICK, *Chemical Laboratory, The College, Winchester* *.

IT has been shown in Part I. (Phil. Mag. xxxviii. p. 240 (1919)) that the work done in getting the molecules in a gramme molecule of liquid into the surface layer is, at low temperatures, $\frac{\rho V}{d}$, where ρ is surface energy in ergs \times cm.²,

V is the molecular volume, and d is the molecular diameter calculated from properties of the vapour. This work was shown to be one-sixth of the internal latent heat of the gramme molecule, which is the work that must be done in order to move all the molecules in the volume V apart from one another against inter-molecular forces (internal pressure) until the liquid has become a vapour. The equation

$$\frac{\rho V}{d} \cdot \frac{1}{J} = \frac{L_1}{6}$$

can be used for the calculation of latent heat at low temperatures only, because in deriving it the assumption is made of contiguity of molecules in the surface layer and absence of "vapour effects" (*loc. cit.* above). The equation given by Bakker, however, (Dissertation, Schiedam, 1888), is of general applicability. Bakker's equation has the general form

$$\int_{v_1}^{v_2} K dv = \lambda_i,$$

where K is internal pressure per unit area across any section in the interior of the liquid. $K dv$ thus represents the work done against internal pressure when the system expands

by dv , and $\int_{v_1}^{v_2} K dv$, where v_1 is the volume of 1 gramme of

liquid and v_2 the volume of 1 gramme of vapour, gives the work done in pulling all the molecules in 1 gramme of liquid apart until the liquid has become vapour. In the absence of an external atmosphere, this work is the internal latent heat per gramme, λ_i . Integrating on the assumption

that K is a function of v of the form $\frac{a}{v^2}$, we get

$$\lambda_i = a \left(\frac{1}{v_1} - \frac{1}{v_2} \right).$$

* Communicated by the Author.

Testing this expression on the assumption that $\frac{a}{v_2} = K$ is identical with van der Waals' $\frac{a}{v_2^2}$, and using values of a_c

derived in accordance with van der Waals' equation from the critical data of the vapour, Bakker found values for λ_i at the boiling-point of about two-thirds of the experimental figures. He drew the conclusion (*Zeit. physik. Chem.* xii. p. 670 (1893)) that a is not independent of the temperature.

Traube (*Ann. der Physik*, v. p. 555 (1901); viii. p. 300 (1902)) has attempted to calculate van der Waals' " b " for liquids by the use of the equation given by van t'Hoff (*Vorles. über Theor. u. Phys. Chem.* iii. p. 30)

$$b_T = v_T - \frac{273v_T}{T_c},$$

(T_c being the critical temperature) together with his theory of "liquidogenic" and "gasogenic" molecules. Values of a_T derived from b_T give no better results than the ordinary "critical" value a_c when used in Bakker's equation. By

combining, however, the author's equation, $\frac{6\rho V}{d} \cdot \frac{1}{J} = L_1$,

with Bakker's equation, it is possible to calculate a value for a_T which can be shown to vary linearly with temperature up to the critical temperature. From a knowledge of a_T and its temperature coefficient it becomes possible to calculate latent heats with very fair accuracy right up to the critical temperature.

Referring to Bakker's equation, it is obvious that at low temperatures v_2 , the volume of the vapour, is very great compared with v_1 , the volume of 1 gramme of liquid. We may write, therefore,

$$\lambda_i = a_T \cdot \frac{1}{v_1}.$$

From the author's equation we have, for the latent heat of vaporization of 1 gramme,

$$\lambda_i = \frac{6\rho v_1}{d}.$$

Hence

$$a_T = \frac{6\rho v_1^2}{d} \dots \dots \dots (1)$$

External latent heats of vaporization per gramme will now be calculated for several liquids by the following procedure:—

- (i.) A value of a_T will be derived from equation (1) at low temperatures.

(ii.) a_T will be assumed to vary linearly with the temperature up to the critical temperature, the temper-

ature coefficient $\frac{\partial a}{\partial T_c}$ being $\frac{a_c - a_T}{T_c - T}$.

(iii.) Values of a_T at various temperatures will be calculated from the temperature coefficient and the value of a found from the surface energy from (1) and substituted in the complete Bakker equation

$$\lambda_i = a_T \left(\frac{1}{v_1} - \frac{1}{v_2} \right).$$

Results are given in Table I. The surface-energy data used are mainly from Jaeger (*Zeit. Anorg. Chem.* ci. pp. 1-214 (1917)). Values of a are expressed as atmospheres pressure \times (volume of 1 gramme molecule of vapour at N.T.P.)². The gramme molecular volume is taken as 22.41 litres at N.T.P. The temperature at which a is calculated from ρ , the surface energy, is shown by the suffix after a and ρ . Young's data (*Sci. Proc. Roy. Dubl. Soc.* xii. p. 414 (1910)) have been used for specific volumes of liquid and vapour, critical data (calculation of a_c), and latent heats. Values of d , the molecular diameter, are those used in Part I.

The connexion between internal and external latent heat has been taken as $\lambda = \lambda_i + \frac{RT}{M}$, where M = molecular weight.

TABLE I.

Latent Heats from Surface Energy and the Critical Data.

Benzene.

$a_c = 0.3822$. $T_c = 288.5$ C. $\rho_{5.4} = 30.9$ ergs \times cm.² $d = 4.88 \times 10^{-8}$ cm.

From equation (1) at 5.4 C.		$a_{5.4} = 0.5808$.		$\frac{\partial a}{\partial T} = -0.000070$	
T	80 C. ^o	100 C.	150 C. ^o	200 C.	250 C.
a_T	0.5286	0.5146	0.4796	0.4446	0.4096
$\lambda_{(calc.)}$	95.4	90.7	80.2	68.0	52.2
$\lambda_{(Young)}$	95.5	91.4	80.9	68.8	[49.5]

Ether.

$a_c = 0.3551$. $T_c = 194$ C. $\rho_0 = 19.2$ ergs \times cm.² $d = 4.41 \times 10^{-8}$ cm.

From equation (1) at 0 C.		$a_0 = 0.5200$.		$\frac{\partial a}{\partial T} = -0.000085$.	
T	35 C.	40 C.	60 C.	100 C.	150 C.
a_T	0.4902	0.4862	0.4690	0.4350	0.3925
$\lambda_{(calc.)}$	84.2	82.6	77.6	67.2	51.5
$\lambda_{(Young)}$	84.0	82.8	78.4	68.4	51.1

Carbon Tetrachloride.

$$a_c = \cdot 03931. \quad T_c = 283^\circ \text{ C.} \quad \rho_0 = 23\cdot 5 \text{ ergs} \times \text{cm.}^2 \quad d = 4\cdot 52 \times 10^{-8} \text{ cm.}$$

$$\text{From equation (1) at } 0^\circ \text{ C.} \quad a_0 = \cdot 06609. \quad \frac{\partial a}{\partial T} = -\cdot 0000946.$$

T	80° C.	150° C.	200° C.	250° C.
a_T	$\cdot 05852$	$\cdot 05190$	$\cdot 04717$	$\cdot 04244$
$\lambda_{(\text{calc.})}$	48·8	39·9	33·2	24·4
$\lambda_{(\text{Young})}$	46·0	38·9	32·6	[23·2]

Chlor-benzene.

$$a_c = \cdot 05187. \quad T_c = 359^\circ \text{ C.} \quad \rho_0 = 35\cdot 9 \text{ ergs} \times \text{cm.}^2 \quad d = 4\cdot 83 \times 10^{-8} \text{ cm.}$$

$$\text{From equation (1) at } 0^\circ \text{ C.} \quad a_0 = \cdot 08684. \quad \frac{\partial a}{\partial T} = -\cdot 0000974.$$

T	132° C.	150° C.	200° C.
a_T	$\cdot 07399$	$\cdot 07223$	$\cdot 06736$
$\lambda_{(\text{calc.})}$	78·5	73·7	65·4
$\lambda_{(\text{Young})}$	74·2	72·3	65·9

Ethyl Formate.

$$a_c = \cdot 03302.* \quad T_c = 235^\circ \text{ C.}* \quad \rho_{22} = 26\cdot 0 \text{ ergs} \times \text{cm.}^2 \quad d = 4\cdot 09 \times 10^{-8} \text{ cm.}$$

$$\text{From equation (1) at } 22^\circ \text{ C.} \quad a_{22} = \cdot 04668. \quad \frac{\partial a}{\partial T} = -\cdot 000064.$$

T	50° C.	100° C.	150° C.	200° C.
a_T	$\cdot 04488$	$\cdot 04169$	$\cdot 03349$	$\cdot 03529$
$\lambda_{(\text{calc.})}$	96·6	84·3	70·7	53·6
$\lambda_{(\text{Young})}$	97·9	85·7	70·5	49·3

Ethyl Acetate.

$$a_c = \cdot 04383.* \quad T_c = 250^\circ \text{ C.}* \quad \rho_0 = 25\cdot 5 \text{ ergs} \times \text{cm.}^2 \quad d = 4\cdot 31 \times 10^{-8} \text{ cm.}$$

$$\text{From equation (1) at } 0^\circ \text{ C.} \quad a_0 = \cdot 06328. \quad \frac{\partial a}{\partial T} = -\cdot 000078.$$

T	80° C.	150° C.	200° C.
$\lambda_{(\text{calc.})}$	81·6	66·4	52·9
$\lambda_{(\text{Young})}$	85·8	69·1	52·7

Methyl Formate.

$$a_c = \cdot 02291. \quad T_c = 214^\circ \text{ C.} \quad \rho_0 \dagger = 27\cdot 7 \text{ ergs} \times \text{cm.}^2 \quad d = 4\cdot 03 \times 10^{-8} \text{ cm.}$$

$$\text{From equation (1) at } 0^\circ \text{ C.} \quad a_0 = \cdot 02920. \quad \frac{\partial a}{\partial T} = -\cdot 000029.$$

T	40° C.	100° C.	150° C.
a_T	$\cdot 02824$	$\cdot 02630$	$\cdot 02585$
$\lambda_{(\text{calc.})}$	112·9	94·8	74·1
$\lambda_{(\text{Young})}$	110·6	92·6	73·6

Methyl iso-butyrate.

$$a_c = \cdot 04946. \quad T_c = 267^\circ \cdot 6 \text{ C.} \quad \rho_0 = 25\cdot 7 \text{ ergs} \times \text{cm.}^2 \quad d = 5\cdot 03 \times 10^{-8} \text{ cm.}$$

$$\text{From equation (1) at } 0^\circ \text{ C.} \quad a_0 = \cdot 07588. \quad \frac{\partial a}{\partial T} = -\cdot 000061.$$

T	90° C.	150° C.	200° C.	250° C.
a_T	$\cdot 07039$	$\cdot 06673$	$\cdot 06368$	$\cdot 06063$
$\lambda_{(\text{calc.})}$	73·4	63·6	53·7	37·2
$\lambda_{(\text{Young})}$	76·3	64·5	51·8	[32·0]

* Guye & Frederich, *Arch. Sci. phys. et natur. Genève*, ix. p. 22 (1900).† Extrapolated from Ramsay & Aston, *Zeit. Phys. Chem.* xv. p. 91 (1894).

The above examples show that from a knowledge of the surface energy of a liquid at a low temperature and the critical data (from which a knowledge of d , the molecular diameter, can be derived), it is possible to calculate the latent heats at temperatures up to the critical temperature with very fair accuracy by means of Bakker's equation. The agreement between calculation and Young's "experimental" values for the latent heat is not so striking as that obtained by Appleby and Chapman (Trans. Chem. Soc. cv. p. 734 (1914) by the use of a modification of Bakker's equation. Appleby and Chapman's expression is, however, open to criticism (*cf.* Sutton, Phil. Mag. [6] xxix. p. 593 (1915)) that cannot be applied to the method used above.

When the value of a at the boiling-point is compared with the value at the critical temperature, it is found that the ratio $\frac{a_{b.p.}}{a_c}$ is approximately constant and equal to 1.4. This figure is supported by Traube's results (*loc. cit.* above), which show that for a large number of liquids the ratio of the latent heat at the boiling-point, calculated from Bakker's equation * using the critical value a_c , to the experimental latent heat is constant and equal to 1.4.

Using this ratio, $\frac{a_{b.p.}}{a_c} = 1.4$, it becomes possible to deduce with precision the semi-empirical relationship between latent heat and absolute boiling-point known as Trouton's Rule. From Bakker's equation at the boiling-point $T \left(\frac{1}{V_2} \right)$, where V_2 is the gramme molecular volume of the vapour, being small), we have

$$\frac{a_T}{V_1} = L_1,$$

V_1 being gramme molecular volume of the liquid and L_1 the internal molecular latent heat. Writing $a_T = 1.4 a_c$ and putting $a_c = \frac{27R^2T_c^2}{64P_c}$, its value in terms of the critical data, we get

$$L_1 = \frac{1.4 \times 27R^2T_c^2}{64P_c \cdot V_1} \dots \dots \dots (2)$$

* Traube used Bakker's equation in its equivalent form

$$\frac{RT}{M} \log \frac{v_1 - b}{v_2 - b} = \lambda.$$

Again, $\frac{RT_c}{P_c V_c}$ is on the average equal to 3.7 (Young, 'Stoichiometry,' p. 211), so that $\frac{RT_c}{P_c} = V_c \cdot 3.7$. We have also the well-known relationship between boiling-point and critical temperature on the absolute scale, namely that $T_{b.p.} = .62 T_c$ (Guldberg, *Zeit. Phys. Chem.* v. p. 376). This, together with the approximate value 2.7 for $\frac{V_c}{V_{b.p.}}$, gives us in the above equation

$$L_1 = \frac{1.4 \times 27 \times 3.7 \times 2.7}{64 \times .62} R \cdot T_{b.p.}$$

Putting $R = 2$ calories, we get

$$\frac{L_1}{T_{b.p.}} = 19.0.$$

To obtain Trouton's Rule in its usual form, we may put

$$L_1 = L - RT_{b.p.},$$

or
$$\frac{L}{T_{b.p.}} = \frac{L_1}{T_{b.p.}} + R,$$

whence
$$\frac{L}{T_{b.p.}} = 19.0 + 2 = 21,$$

which is in very good agreement with the mean empirical value 20-22. It thus appears that Trouton's Rule is merely Bakker's equation expressed in terms of the principle of corresponding states, and liquids to which that principle does not apply approximately may be expected to give values for $\frac{L}{T_{b.p.}}$ differing from the mean value 20-22.

For oxygen at its boiling-point we have :-

$$\frac{T_c}{T_{b.p.}} = 1.72, \quad \frac{V_c}{V_{b.p.}} = 2.17^*, \quad \frac{RT_c}{P_c V_c} = 3.419 \dagger, \quad \frac{\alpha_{b.p.}}{\alpha_c} = 1.467,$$

whence $\frac{L}{T_{b.p.}} = 17.2$. By the application of Nernst's modification of Clausius' equation, $\frac{L}{T_{b.p.}} = 18.0$ (Nernst, *Theor. Chem.* p. 273).

* From mean value of v_c in Kaye and Laby's Tables.

† Young's 'Stoichiometry,' p. 212.

For nitrogen, we have :—

$$\frac{T_c}{T_{b,p}} = 1.64, \quad \frac{V_c}{V_{b,p}} = 2.65^*, \quad \frac{RT_c}{P_c V_c} = 3.421, \quad \frac{\alpha_{b,p}}{\alpha_c} = 1.32,$$

whence $\frac{L}{T_{b,p}} = 18.5$. Observed (Nernst as above) $\frac{L}{T_{b,p}} = 17.6$

Similarly, for argon :

$$\frac{L}{T_{b,p}} (\text{calc.}) = 18.6, \quad \text{observed} = 17.3.$$

Turning once more to the equation

$$L_1 = \frac{6\rho V}{d} \cdot \frac{1}{J},$$

we can derive the ordinary "external" molecular latent heat as

$$L = \frac{6\rho V}{d} \cdot \frac{1}{J} + RT,$$

$$\text{whence} \quad \frac{L - RT}{V\rho} = \frac{6}{d} \cdot \frac{1}{J},$$

$$\text{or} \quad \frac{L}{V\rho} = \frac{6}{dJ} + \frac{RT}{V\rho} \dots \dots \dots (3)$$

Now according to Walden, $\frac{L}{V\rho}$ is approximately constant for a large number of liquids at their boiling-points and equal to 3.64. Looking at the right-hand terms of equation (3) it is at once apparent that approximate constancy is to be expected. The molecular diameter d has the average value of about 4.5×10^{-8} cm. for the common organic substances and variations from this mean value are not very great. Neglecting for the moment the term $\frac{RT}{V\rho}$, which, with R in calories, is small, we find for $\frac{L}{V\rho}$ the mean value 3.2. When we introduce the term $\frac{RT}{V\rho}$ (R in calories, ρ in ergs \times cm.²), we find that 3.2 must be increased, on the average, to 3.55. In Table II. results are given of the calculation of $\frac{L (\text{cals.})}{V\rho (\text{ergs})}$ for a few liquids.

* From v_c on p. 60, Lewis' 'System of Physical Chemistry, and $v_{b,p}$ Ramsay and Drugman, J. C. S. lxxvii. p. 1228 (1910).

TABLE II.

Substance.	$d \times 10^8$ cms.	$\frac{6}{d} \times \frac{1}{J}$.	$\frac{RT \text{ (cals.)}}{V\rho \text{ (ergs)}}$.	$\frac{L}{V\rho}$ (found).	$\frac{L}{V\rho}$ (calc.).
Ether	4.41	3.26	.36	3.62	3.62
CS ₂	4.18	3.43	.38	3.82	3.81
Ethyl formate	4.09	3.51	.30	3.35	3.81
Ethyl acetate	4.31	3.33	.38	3.98	3.71
Ethyl iodide	4.20	3.42	.36	3.83	3.78
Methyl iso-butyrate ...	5.03	2.85	.35	3.68	3.20
CCl ₄	4.52	3.18	.33	3.43	3.51
CHCl ₃	4.34	3.31	.36	3.78	3.67
Benzene	4.88	2.94	.35	3.75	3.29
Toluene	4.84	2.97	.33	3.33	3.30
Aniline	4.70	3.05	.33	3.31	3.38
Oxygen	3.21	4.47	.47	5.01	4.94
Nitrogen.....	3.50	4.10	.50	4.43	4.60

The data used are from the same sources as in Table I. Excluding oxygen and nitrogen, the mean of each column for $\frac{L}{V\rho}$ is 3.6. The agreement between the "observed" and calculated results for oxygen and nitrogen is particularly interesting.

It will be noticed that the expression $\frac{RT \text{ (cals.)}}{V\rho \text{ (ergs)}}$ is approximately a constant for the organic liquids. Its significance will be discussed in a later communication.

When surface energy is expressed as "specific cohesion," defined by

$$a^2 = \frac{2\rho}{s \times 9.81} \text{ milligrammes weight per mm.}$$

($s = \text{sp. gr.}$), we get, putting the author's equation in the form

$$\frac{1}{J} \cdot \frac{\rho v}{d} = \frac{\lambda_i}{6}$$

($v = \text{specific volume}$,
 $\lambda_i = \text{internal latent heat per gramme}$),

$$\rho = \frac{\lambda_i \cdot d \cdot J}{6v},$$

whence
$$a^2 = \frac{2\lambda_i \cdot d \cdot J}{6 \cdot s \cdot v \cdot 9.81},$$

or
$$\frac{\lambda_i}{a^2} = \frac{3 \times 9.81}{d \cdot J}.$$

Since $\lambda_i = \lambda - \frac{RT}{M}$, we get

$$\frac{\lambda}{a^2} = \frac{3 \times 9.81}{d \cdot J} + \frac{RT}{Ma^2} \quad \dots \quad (4)$$

Giving as in (3) the mean value 4.5×10^{-8} to d , the molecular diameter, $\frac{3 \times 9.81}{d \cdot J}$ becomes 15.64. Also $\frac{RT}{Ma^2}$ is equivalent to $\frac{RT}{V\rho} \times \frac{9.81}{2}$; from Table II., $\frac{RT}{V\rho}$ is about .35 for organic liquids, so that $\frac{RT}{Ma^2}$ is about 1.72. Hence $\frac{\lambda}{a^2} = 17.4$. Walden's mean value is 17.9.

Equation (4) is merely (3) altered to provide for the expression of surface energy as "specific cohesion." Walden has, however, combined his empirical relation $\frac{\lambda}{a^2}$ with Trouton's Rule, and obtained $\frac{Ma^2}{T_{b.p}} = 1.2$. We can deduce this result at once. For Trouton's Rule we have found $\frac{\lambda M}{T_{b.p}} = 21$ (p. 37) or $\lambda = 21 \cdot \frac{T_{b.p}}{M}$. For $\frac{\lambda}{a^2}$ the mean value 17.4 has been deduced; hence $\frac{Ma^2}{T_{b.p}} = \frac{21}{17.4} = 1.3$.

If the freezing-point can be regarded as being approximately a corresponding temperature, we can obviously derive Walden's melting-point relationship $\frac{Ma^2}{T_{m.p}} = \text{constant}$.

The mean value found by Jaeger is 3.65; variations from the mean are, however, considerable. Thus for benzene at 5° 4 C. the value 1.97 is found. By calculation from Jaeger's data and $d = 4.88 \times 10^{-8}$ cm., we find, on the lines of equation (4), $\frac{\lambda}{a^2} = 15.44$ at the melting-point 5° 4 C. (288° 4 absolute). From the data :

$$\frac{T_{m.p}}{T_c} (\text{absolute}) = 2.02, \quad \frac{v_c}{v_{m.p}} = 2.94, \quad \frac{RT_c}{P_c V_c} = 3.755,$$

$$\frac{\alpha_{m.p}}{\alpha_c} = \frac{.05808}{.03822} (\text{p. 34}) = 1.52, \quad \text{we find } \frac{M\lambda}{T_{m.p}} = 28.6;$$

whence $\frac{a^2 M}{T_m}$ for benzene at its melting-point comes to 1.86.

From equation (1) we have

$$\rho V^2 = \frac{a_T \cdot d}{6} \quad (V = \text{gramme molecular volume}),$$

or $\rho V^{\frac{2}{3}} = \frac{a_T}{V} \cdot \frac{d}{V^{\frac{1}{3}}} \cdot \frac{1}{6}$ at low temperatures.

Expressing a_T as $z \cdot a_c$ and a_c in terms of the critical constants we get

$$\rho V^{\frac{2}{3}} = \frac{27}{64} \cdot \frac{R^2 T_c^2}{P_c} \cdot \frac{1}{V} \cdot z \cdot \frac{d}{V^{\frac{1}{3}}} \cdot \frac{1}{6}.$$

At any (low) temperature T , we may write

$$\frac{T_c}{T} = x, \quad \frac{V_c}{V} = y, \quad \frac{RT_c}{P_c V_c} = \psi,$$

whence $\rho V^{\frac{2}{3}} = \frac{27}{64} \times R \cdot T \cdot x \cdot y \cdot z \cdot \psi \cdot \frac{d}{6V^{\frac{1}{3}}}$.

If $x = \frac{T_c}{T}$ and $\tau = T_c - T$, then $T = \frac{\tau}{x-1}$; hence

$$\rho V^{\frac{2}{3}} = \frac{27}{64} \cdot \frac{R \cdot x \cdot y \cdot z \cdot \psi}{x-1} \cdot \frac{d}{6V^{\frac{1}{3}}} \cdot \tau.$$

or $\frac{\rho V^{\frac{2}{3}}}{\tau} = \frac{27}{64} \cdot \frac{R \cdot x \cdot y \cdot z \cdot \psi}{x-1} \cdot \frac{d}{6V^{\frac{1}{3}}}$. . . (5)

According to the well-known Ramsay-Eötvös empirical relationship the left-hand term, $\frac{\rho V^{\frac{2}{3}}}{\tau}$, is very nearly constant

over a wide temperature range for "non-associated" liquids. Owing to the limitation of equation (1) to low temperatures, we can draw no conclusions from the right-hand term of equation (5) at higher temperatures. Confining ourselves to low temperatures (boiling-point and under), we may notice that ψ is approximately a constant and that x and y will be the same for many liquids at corresponding temperatures; z has been shown to be a constant (1.4) at the corresponding temperature of the boiling-point, and is probably a constant at other such temperatures. If, there-

fore, it can be shown that $\frac{d}{V^{\frac{1}{3}}}$ is approximately constant for

different liquids at corresponding temperatures, the constancy of the Ramsay-Eötvös ratio will have been deduced for, at any rate, corresponding temperatures.

In Table III., $V^{\frac{1}{3}}$ and d are compared for a number of substances at their boiling-points. The necessary data were

taken partly from Smiles, 'Physical Properties and Chemical Constitution,' p. 112, and partly from the papers of Jaeger and Young already referred to.

TABLE III.

Substance.	$V^{\frac{1}{3}}$ c.c.	$d \times 10^8$ cms.	$\frac{d}{V^{\frac{1}{3}}} \times 10^8$.
Benzene	4.61	4.88	1.06
Ether	4.73	4.41	1.19
CS ₂	3.89	4.18	1.07
CCl ₄	4.70	4.52	.98
CHCl ₃	4.39	4.34	1.00
Methyl formate	3.99	4.03	1.01
Methyl acetate	4.39	4.03	.89
Methyl isobutyrate	5.02	5.03	1.00
Ethyl formate	4.39	4.09	.90
Ethyl acetate	4.75	4.31	.90
Ethyl iodide	4.41	4.20	.96
Aniline	4.78	4.70	.99
Toluene	4.55	4.84	1.06
<i>p.</i> Xylene	5.20	5.16	.99
Mesitylene	5.45	5.35	.98
Chlor-benzene	4.83	4.83	1.00
Anisol	5.00	4.98	1.00
Oxygen	3.04	3.21	.99
Nitrogen	3.21	3.50	1.09
Argon	3.05	3.21	1.05

$$\text{Mean } \frac{d}{V^{\frac{1}{3}}} \times 10^8 = 1.005.$$

From the principle of corresponding states it follows that a similar constancy will be found at other corresponding temperatures (unless, of course, d varies with temperature), and the Ramsay-Eötvös relation has therefore been deduced for *corresponding temperatures*. It has not been shown that the ratio $\frac{\rho V^{\frac{2}{3}}}{\tau}$ should have the same value at all corresponding temperatures; in fact, the mode of deduction of (5) would lead to the contrary expectation. Thus $\rho V^{\frac{2}{3}}$ is obviously proportional to $\frac{\rho V}{d}$, which is equivalent to $\frac{L_1}{6}$ (*cf.* Part I.); the variation of L_1 with temperature is by no means the same for all substances. And as a matter of fact Jaeger's recent very careful determinations of surface energy show that the Ramsay-Eötvös "K" does definitely vary with temperature. The variation is, however, small and, as will be seen in Table IV., is accounted for by equation (5); it

and Surface Energy.

TABLE IV.

Substance:	T °C.	ρ ergs/cm. ²	x.	y.	z.	ψ .	$d \times 10^3$ c.m.	s sp. gr.	K (calc.)	K* (observed).
Ether	0	19.2	1.71	2.80	1.40	3.813	4.41	735	2.02	2.14
	35°	15.9	1.52	2.66	1.33	699	2.16	2.17
Benzene	5.4	30.9	2.02	2.94	1.52	3.755	4.88	895	2.15	2.15
	80	20.7	1.59	2.66	1.33	813	2.24	2.10
COCl ₂	0	28.5	2.04	2.93	1.59	3.680	4.52	1.632	1.96	2.08
	76.4	20.2	1.56	2.65	1.41	1.477†	2.16	2.16
Ethyl acetate	0	25.5	1.916	3.00	1.54	3.949	4.31	.924	2.13	2.13
	80	17.2	1.48	2.68	1.37824	2.38	2.28
Argon §	-186	11.00	1.79	2.76	1.26	3.283	3.21	1.404	1.60	1.72
Nitrogen §	-196	8.94	1.65	2.72	1.26	3.391	3.50	.8126	1.87	1.89

* Calculated from $\rho V^{\frac{2}{3}} = K(T - T_0)$, chiefly from Jaeger's data.† R. & S. = Ramsay & Shields, *cf.* Nernst, *Theor. Chem.*, p. 275.§ Data from Baly & Donnan, *J. C. S.* lxxxii. p. 907 (1902).

also makes it unnecessary to compare liquids at corresponding temperatures.

A "general" value for $\frac{\rho V^{\frac{2}{3}}}{\tau}$ will now be calculated from (5) at the boiling-point, using the following data:—

$$R=2 \text{ calories} = 2 \times 4.18 \times 10^7 \text{ ergs, } x=1.62, y=2.7, \\ z=1.4, \psi=3.7, \frac{d}{V^{\frac{2}{3}}} = 1 \times 10^{-8}.$$

We obtain $\frac{\rho V^{\frac{2}{3}}}{\tau} = K = 2.17$, in very good agreement with the empirical value.

In Table IV. will be found some calculations of K for a few individual liquids at the boiling-point and at some other non-corresponding temperature.

Here again, in the case of argon and nitrogen, theory is able to predict "abnormal" values.

From the equation

$$\frac{\rho V}{d} \cdot \frac{1}{J} = \frac{L_1}{6}$$

we have

$$\rho V^{\frac{2}{3}} = L_1 \cdot \frac{d}{V^{\frac{1}{3}}} \cdot \frac{1}{6}.$$

At the boiling-point $\frac{d}{V^{\frac{1}{3}}}$ has been found to be 1.0×10^{-8} for many liquids. We therefore have

$$\frac{d(\rho V^{\frac{2}{3}})}{dT} = \frac{d}{6} \left\{ \frac{1}{V^{\frac{1}{3}}} \cdot \frac{dL_1}{dT} - \frac{L_1}{3} \cdot \frac{1}{V^{\frac{4}{3}}} \cdot \frac{dV}{dT} \right\} \\ = \frac{10^{-8}}{6} \left\{ \frac{dL_1}{dT} - \frac{L_1}{3} \cdot \alpha \right\},$$

where $\alpha = \frac{1}{V} \cdot \frac{dV}{dT} = \text{coefficient of expansion.}$

Expressing L_1 in ergs ($J = 4.18 \times 10^7$ ergs),

$$\frac{d(\rho V^{\frac{2}{3}})}{dT} = \frac{.418}{6} \left(\frac{dL_1}{dT} - L_1 \alpha \right), \quad \dots \quad (6)$$

$$\text{or} \quad \frac{d(\rho V^{\frac{2}{3}})}{dT} = .07M \left(\frac{d\lambda_i}{dT} - \lambda_i \alpha \right). \quad \dots \quad (6a)$$

This relation is implicit in the combination of equation (1) and Bakker's equation used to calculate latent heats at various temperatures, and a special test of it is therefore not

necessary. It is of interest, however, to calculate $\frac{d(\rho V^{\frac{2}{3}})}{dT}$ from latent heat data. Three examples of such calculation are therefore given in Table V. The data used are Young's.

TABLE V.

Substance.	°C.	$\alpha = \frac{1}{V_T} \frac{\partial V}{\partial T}$	λ_i cals. \times gr.	$\frac{\partial \lambda_i}{\partial T}$	$\cdot 07M \left(\frac{\partial \lambda_i}{\partial T} - \lambda_i \alpha \right)$	$\partial \left(\frac{\rho V^{\frac{2}{3}}}{\partial T} \right)$ (Jaeger).
Benzene.....	80°	·00125	86·5	-·28	-1·73	-1·85
Ether.....	35	·00172	75·7	-·26	-1·60	-1·70
Ethyl acetate...	80	·00160	83·96	-·203	-1·53	-1·30

Matthews (Jour. Phys. Chem. xx. p. 554 (1916)) has derived an expression for the Ramsay-Eötvös relation by a method that bears some resemblance to that employed above. He obtains a connexion between surface energy, latent heat, and Bakker's equation; he assumes, however, that van der Waals' "a" is independent of temperature. His reasoning, moreover, involves certain rather indeterminate assumptions in connexion with the intra-molecular energies of liquid and gaseous molecules, and depends on Goldhammer's empirical relation between liquid and gaseous densities and temperature (*Zeit. Phys. Chem.* lxxi. p. 577 (1910)). His calculations of "K" are nevertheless remarkably exact.

The empirical relationships that have been shown above to have a theoretical justification have been used to calculate the association of liquids with which marked deviations from the empirical constants have been obtained. The usual procedure has been, when an "abnormal" constant is obtained, to find a number n by which M , the molecular weight of the simple or gas molecule, must be multiplied in order that the average or normal constant may be obtained. A glance at the expressions derived for Trouton's Rule, Walden's relations, and the Ramsay-Eötvös "law" shows that such procedure is quite unjustifiable. Where the expressions involve the molecular diameter d , the assumption would be involved that the diameter of the associated complex is the same as that of the simplest gas molecule. This of itself might not involve serious error, since d varies but slowly with increasing molecular complexity; equations (3) and (4) might therefore be expected to give approximate degrees of association. Trouton's Rule and the Ramsay-Eötvös law, as given by (2) and (5), contain, however, both d and critical data, which refer to the non-associated vapour (*cf.* Tyrer, *Zeit. Phys. Chem.* lxxx. p. 50 (1912)).

Summary.

(1) On the assumption that van der Waals' a varies with temperature, a relation is derived between a_T , surface energy, and molecular volume.

$$a_T = \frac{6\rho V}{d}.$$

This equation is valid only at low temperatures.

By assuming that a_T diminishes linearly with temperature to the critical value a_c , latent heats are calculated by the use of Bakker's equation for several liquids.

(2) Recognition of the fact that the ratio $\frac{a_T}{a_c}$ at the boiling-point is the same for many liquids results in the derivation of Trouton's Constant.

(3) Walden's empirical relationships between surface energy and latent heats and the Ramsay-Eötvös law are deduced.

V. *Contribution to the Quantum Theory of Spectrum Emission: Spectra of Atomic Systems containing a Complex Nucleus**.
By L. SILBERSTEIN, Ph.D., Lecturer in Mathem. Physics at the University of Rome †.

1. **W**HEREAS in all investigations hitherto published, or at least in all those which have come to my knowledge, the atomic nucleus (positive charge) is treated as a homogeneous sphere or, equivalently, as an ordinary point-charge, the purpose of the present paper will be to investigate, on the lines of the quantum theory, the spectrum corresponding to an atomic system with any differently shaped nucleus which will shortly be called a *complex nucleus*. Such would, for instance, be a nucleus consisting of two point-charges, acting as two fixed centres, —or any other axially symmetrical distribution of positive charge. The most general "complex" or *aspherical* nucleus would be a charge distribution having no axis and no plane of symmetry.

If $-e$ be the charge of an electron proper, it is generally assumed by the followers of Rutherford's and Bohr's theories that the nucleus of a hydrogen atom has the (net) charge e , that of a helium atom the charge $2e$, and

* A summary of the results of the present investigation and some illustrating examples were given by the author at the Bournemouth meeting of the British Association, September 1919, Section A.

† Communicated by the Author.

so on, generally κe , where κ is an exact (positive) integer. Now, in the case of helium and, *a fortiori*, of more complex atoms, it is certainly inadmissible to treat the nucleus as a point-charge. But even in the case of hydrogen there is no reason (besides a tendency to mathematical simplification) *a priori* to assert that its single nucleus-charge has a radially symmetric distribution. Under such circumstances it is scarcely necessary to justify an investigation into the spectral behaviour of differently shaped nuclei.

2. No matter what the shape of a nucleus may be, we will call its total charge* κe , and we will denote by $-e$ and m the charge and the mass of the electron moving around it. No account will be taken of the perturbations due to other electrons or planets belonging to the same system. Again, the relativistic complications (already studied by Sommerfeld †) will be disregarded, and the electronic mass m will, therefore, be treated as a constant. In short, the system will be treated on Newtonian principles, as far, of course, as the "stationary" orbits are concerned. It is well-known that under these circumstances, and if the nucleus be a simple *point-charge*, the negatived total energy W belonging to any one of the stationary orbits is given by

$$\frac{1}{ch} W = \frac{\kappa^2 R}{n^2}, \dots \dots \dots (1)$$

where n is an integer, c the light velocity in vacuo, h Planck's constant, and R the Bohr expression of Rydberg's constant, *i. e.*

$$R = \frac{2\pi^2 e^4 m'}{ch^3}, \quad m' = \frac{Mm}{M+m} \dots \dots \dots (2)$$

M being the mass of the nucleus, and therefore, practically, the whole mass of the atom. If ν be the reciprocal wavelength or (what is improperly called) the frequency, the corresponding spectrum is, by Bohr's fundamental assumption, $\nu = (W_n - W_n)/ch$, *i. e.*, by (1),

$$\nu = \kappa^2 R \left(\frac{1}{n'^2} - \frac{1}{n^2} \right), \dots \dots \dots (3)$$

where n' is a fixed, and n a variable integer. In fine,

* In usual electrostatic (irrational) units.

† A. Sommerfeld, *Annalen der Physik*, vol. li. 1916, pp. 1 *et seq.* especially Part II. p. 44 *et seq.* The latter is open to some serious objections which will be pointed out in a later publication.

the spectrum is always a (generalized) Balmer series of simple, that is, of ideally sharp lines, showing no fine structure. It will be kept in mind that this Balmerian type of the series and the singleness (and ideal thinness) of its members or lines theoretically persists, no matter how small or how large the dimensions of the stationary orbits. Both are general features, being consequences of the $\frac{1}{r^2}$ -law of the field and of the irrelevance of the diameter of the simple nucleus.

Such being the well-known result for a point-nucleus, our problem will be to investigate the complications of the series, and more especially of the fine structure of its members, due to the complexity of the nucleus.

In what follows the meaning of the above symbols will be retained throughout.

3. *Nucleus consisting of two fixed centres (point-charges).* This is the only case of a complex nucleus which can, for any dimensions of the orbits, be rigorously solved, *i. e.* reduced to quadratures, and ultimately to known elliptic integrals. This is the reason why it is here mentioned at all. But the general and complete solution of this problem, famous since the times of Jacobi*, has in our connexion but a purely theoretical interest. (Since those orbits only are spectroscopically relevant whose dimensions are very large as compared with those of the nucleus.) It will, therefore, be enough to give here but a general outline of the theory of such a system, omitting all the particular results arrived at by the writer †.

Let $2a$ be the mutual distance of the two centres, and let each carry one-half of the total charge of the nucleus, *i. e.* $\frac{1}{2}\kappa e$. (The case of unequal charges is not essentially more complicated.) Take the axis of symmetry (join of centres) as the x -axis, with mid-point as origin, and denote by y the distance from this axis. Then, with the well-known transformation of Jacobi,

$$x = a \cosh \xi \cdot \cos \eta, \quad y = a \sinh \xi \cdot \sin \eta,$$

the potential energy will be

$$V = -\frac{\mu \cosh \xi}{\cosh^2 \xi - \cos^2 \eta}, \quad \mu = \frac{\kappa e^2}{a}, \quad \dots \quad (4)$$

* Its integrability was already discovered by Euler.

† Some of these results with the corresponding type of spectra were described at the Bournemouth meeting, without being recorded in the much abbreviated Report.

and the kinetic energy,

$$T = \frac{1}{2}m'a^2(\cosh^2 \xi - \cos^2 \eta) \cdot (\dot{\xi}^2 + \dot{\eta}^2) + \frac{1}{2}m'a^2 \sinh^2 \xi \cdot \sin^2 \eta \cdot \dot{\phi}^2, \quad (5)$$

where ϕ is the angle between the variable and an arbitrarily fixed meridian plane. The moments corresponding to the canonical coordinates ξ, η, ϕ (which are the derivatives of T with respect to $\dot{\xi}, \dot{\eta}, \dot{\phi}$) are

$$\left. \begin{aligned} p_1 &= m'a^2(\cosh^2 \xi - \cos^2 \eta)\dot{\xi}, & p_2 &= m'a^2(\text{idem})\dot{\eta}, \\ p_3 &= m'a^2 \sinh^2 \xi \cdot \sin^2 \eta \cdot \dot{\phi}. \end{aligned} \right\} \quad (6)$$

Since the energy does not contain ϕ , we have, as one of the canonical equations, $dp_3/dt = 0$, *i. e.*

$$p_3 = \text{const.},$$

an obvious result. Thus, one of the quantizing equations will simply be

$$\int_0^{2\pi} p_3 d\phi = 2\pi p_3 = hn_3, \quad \dots \quad (7)$$

where n_3 is an integer. And since there is with ξ, η what is familiar as "separation of variables," the other two equations will be, according to the principles used by Sommerfeld, Epstein, and others,

$$\int p_1 d\xi = n_1 h, \quad \int p_2 d\eta = n_2 h, \quad \dots \quad (8)$$

where n_1, n_2 are two more integers. (For integration limits *cf. infra*.) Using the well-known method of separation of variables, and denoting by W the constant value of $-V - T$, we have at once the two first integrals, which are Jacobi's integrals,

$$\left. \begin{aligned} p_1 &= a\sqrt{2m'W} \cdot \sqrt{\beta - \cosh^2 \xi + \frac{2\mu}{W} \cosh \xi - P^2/\sinh^2 \xi}, \\ p_2 &= a\sqrt{2m'W} \cdot \sqrt{-\beta + \cos^2 \eta - P^2/\sin^2 \eta}, \end{aligned} \right\} \quad (9)$$

where $P^2 = \frac{p_3^2}{2m'a^2W} = \frac{h^2 n_3^2}{8\pi^2 m'a^2W}$, and β is an integration constant.

With the values (9) of p_1, p_2 we have in (8) two equations for the purpose of quantizing β and W . Thus the problem of finding the required

$$W = W(n_1, n_2, n_3)$$

corresponding to the stationary orbits, and thence the spectrum

series $\nu = \frac{1}{ch} \Delta W$, is reduced to quadratures, and ultimately to finding β and W from the two transcendental equations (containing elliptic integrals) by successive approximations. This gives rise to a variety of intricate spectral types, whose description, however, need not—for reasons stated a moment ago—detain us any further in the present paper.

It remains only to say a few words about the limits of the integrals to be applied in (8). Since, by (6), ξ and η vanish only together with p_1 and p_2 respectively, the required limits will be determined by the roots of the equations

$$p_1(\xi) = 0, \quad p_2(\eta) = 0, \quad (10)$$

the left-hand members of these equations being as on the right hand of (9). The first of (10) is a quartic for $\cosh \xi = u$, say, and the second a quadratic for $\cos^2 \eta$. Of the four roots of the former two only, say u_1, u_2 , will be found available*, and if we require the electron not to leave the system (not to escape to “infinity”), both of these will certainly be available. And the roots η_1, η_2 of the second equation will be either both complex or both real. Thus, in general, the electron's orbit will be contained between the two ellipsoids (of revolution) $\xi_1 = \text{const.}$, $\xi_2 = \text{const.}$, and it will either pierce incessantly all the hyperboloids $\eta = \text{const.}$ or be hedged in between the two hyperboloids $\eta_1 = \text{const.}$, $\eta_2 = \text{const.}$ † Thus p_1 will be integrated from the inner to the outer ellipsoid and back again, and p_2 either over 2π , if η increases (or decreases) incessantly or between the two limiting hyperboloids (twice), if η oscillates. In particular, we may have $\xi = \text{const.}$ throughout, and therefore $\xi_1 = \xi_2$; this for instance is possible for $\dot{\phi} = 0$, when the electron describes an ellipse in the meridian plane. And if the two roots η_1, η_2 (are real and) coincide with one another we have $\eta = \text{const.}$; a possible motion of this kind occurs, for example, for $\dot{\phi} = 0$, when the electron oscillates along an arc of an hyperbola stretching within an ellipse $\xi = \text{const.}$ in the meridian plane. A sub-case of this is the obviously possible to-and-fro motion along a straight perpendicular to the axis and passing through the mid-point of the two electric centres. The formulæ for the special types of spectra corresponding to

* *I. e.* not only real but also positive and ≥ 1 , so as to yield real ξ_1, ξ_2 .

† Needless to say that $\xi = \text{const.}$, $\eta = \text{const.}$ are all confocal ellipsoids and hyperboloids (of two sheets) with the axis of the nucleus as axis of symmetry and the two electric centres as foci.

elliptic and to hyperbolic (oscillatory) motions can be written down with comparative ease. But details of this kind need not detain us here any further.

4. *Large orbits.* Let the nucleus still consist of two equal centres, $\frac{1}{2}\kappa e$, at a distance $2a$ apart, but let us confine our attention to electronic orbits whose smallest diameter is large as compared with this distance. That such and only such orbits are physically interesting will become manifest if it is remembered that while the dimensions of the spectroscopically relevant orbits are at least as large as 10^{-8} cm., the dimensions of the nucleus are, according to Rutherford's scattering experiments, certainly smaller than 10^{-11} cm., and possibly much smaller than this.

Such being the case, let r be the radius vector of the electron (drawn from the midpoint of the binary nucleus), and let us assume that $\frac{a}{r}$ is permanently a small fraction.

This excludes, for instance, all the hyperbolic orbits $\eta = \text{const.}$ mentioned in the last section; for each of these passes through the axis right between the two centres (thus pushing r below a). Of course, a multitude of other types of motion is excluded by the assumption of small a/r , and what remains are quasi-keplerian motions, with orbits (in our case of a non-escaping electron) but slightly deviating from ellipses.

The problem in hand could be treated by means of the more general, rigorous, formulæ of Section 3, with obvious simplifications. In fact, since $r^2 = x^2 + y^2$, we have

$$r^2 = a^2(\cosh^2 \xi \cos^2 \eta + \sinh^2 \xi \sin^2 \eta)$$

or

$$\frac{r^2}{a^2} = \sinh^2 \xi + \cos^2 \eta,$$

so that $\frac{r}{a}$ large means large ξ , and therefore, $\sinh \xi \doteq \cosh \xi \doteq \frac{1}{2} e^\xi$,

$$\text{and} \quad r \doteq \frac{1}{2} a e^\xi,$$

while η becomes simply the angle between the radius vector and the axis. This introduces at once considerable simplifications into the formulæ (9), and so on.

But the present problem can be dealt with much more simply by treating the atomic system as an ordinary system, with a simple point-charge as nucleus, subjected to slight perturbations. For this purpose it is enough to write down the disturbing function F and to find its average \bar{F} for

a period of the undisturbed motion. In fact if W_0 be the (negative) energy of the undisturbed system, the energy corresponding to a "stationary" orbit of the disturbed system will be, by a theorem due to Bohr*, here extended, tentatively, to three degrees of freedom,

$$W = W_0 + \bar{F}, \quad \dots \dots \dots (11)$$

where the planetary elements entering into \bar{F} are to be quantized exactly as in the principal term W_0 corresponding to the simple-nucleus atom.

Now, the negative potential energy of our system is

$$-V = \frac{1}{2} \kappa e^2 \left(\frac{1}{r_1} + \frac{1}{r_2} \right),$$

where r_1, r_2 are the distances of the electron from the two centres. If η be the angle contained between the radius vector r and the axis, drawn from centre 2 towards centre 1, we have

$$\frac{r}{r_1} = \left[1 + \frac{a}{r} \left(\frac{a}{r} - 2 \cos \eta \right) \right]^{-\frac{1}{2}} = \sum_0^{\infty} \left(\frac{a}{r} \right)^n P_n(\eta),$$

and

$$\frac{r}{r_2} = \left[1 + \frac{a}{r} \left(\frac{a}{r} + 2 \cos \eta \right) \right]^{-\frac{1}{2}} = \sum_0^{\infty} \left(\frac{a}{r} \right)^n P_n(\pi - \eta),$$

where the P_n are zonal spherical harmonics. And since, for odd n , $P_n(\eta) + P_n(\pi - \eta) = 0$, and for even n , $P_n(\eta) = P_n(\pi - \eta)$, we have, for any $\frac{a}{r} < 1$,

$$\frac{1}{r_1} + \frac{1}{r_2} = \frac{2}{r} \sum_0^{\infty} \left(\frac{a}{r} \right)^{2n} P_{2n}(\eta),$$

and therefore,

$$-V = \frac{\kappa e^2}{r} \sum_0^{\infty} \left(\frac{a}{r} \right)^{2n} P_{2n}(\eta). \quad \dots \dots \dots (12)$$

Thus the disturbing function, up to $\left(\frac{a}{r} \right)^4$, is

$$F = \mu \left(\frac{a}{r} \right)^3 \cdot (3 \cos^2 \eta - 1), \quad \dots \dots (13)$$

where

$$\mu = \frac{\kappa e^2}{2a}. \quad \dots \dots \dots (14)$$

* 'Quantum Theory of Line Spectra,' Copenhagen, 1918, Part II, p. 49.

It remains to average F over a period of the undisturbed motion and to substitute the result into (11).

Let the plane of the undisturbed (osculating) orbit make with the equatorial plane (*i. e.* the plane through O , perpendicular to the axis) the angle i ; this will be the *inclination* of the orbit. Further, let ω be the *longitude of the perihelion*, counted from the ascending node Ω_0 (the line of nodes being the intersection of the orbit plane with the fixed equatorial plane), and θ the angle between the instantaneous radius vector and $O\Omega$. Then, if ϵ be the eccentricity, the equation of the orbit is

$$\frac{1}{r} = \frac{\kappa e^2 m'}{p^2} [1 + \epsilon \cos(\theta - \omega)], \dots (15)$$

where $p = m r^2 \dot{\theta} = \text{const.}$, and our previous η is related to i, θ by

$$\cos \eta = \sin i \cdot \sin \theta. \dots (16)$$

The disturbing function (13) becomes, by (15) and (16),

$$F = b \cdot [1 + \epsilon \cos(\theta - \omega)]^3 \cdot [3 \sin^2 i \sin^2 \theta - 1],$$

where

$$b = \mu \left(\frac{\kappa a e^2 m'}{p^2} \right)^3 = 8 \mu^4 \left(\frac{a^2 m'}{p^2} \right)^3. \dots (17)$$

Whence, the required average $\bar{F} = \frac{1}{2\pi} \int_0^{2\pi} F d\theta$,

$$\bar{F} = \frac{3}{2} b \cdot \sin^2 i [1 + \frac{3}{4} \epsilon^2 (1 + 2 \sin^2 \omega)] - b(1 + \frac{3}{2} \epsilon^2). (18)$$

Notice that this mean value of the disturbing function contains *four* of the elements of the undisturbed orbit, to wit, its parameter through p (appearing in b), its inclination i , eccentricity ϵ , and the *longitude of the perihelion* ω . Of these only the three first can be “*quantized*” (*i. e.* fixed in terms of integers and h), while the last, ω , will retain its freedom of assuming any value between 0 and 2π . This feature, most immediately conditioned by the absence of radial symmetry or isotropy (replaced by axial symmetry) will give rise to diffuse lines, *i. e.* spectrum lines of finite breadth. The only orbits which will give rise to ideally sharp lines will be those for which $\epsilon \cdot \sin i$, the coefficient of the non-quantizable term in (18), vanishes, *i. e.* all circular orbits, whatever their inclination, and all equatorial orbits, whatever their eccentricity. This will become more clear presently.

Let us now quantize the three elements p, i, ϵ by the usual

principles, according to what was said above, immediately after formula (11). This will be done exactly as in that part of Sommerfeld's paper (*Ann. der Phys.* vol. 51) which is based on simple Newtonian mechanics, *i. e.* without relativistic refinements and, of course, for the undisturbed system (nucleus = point-charge). Namely, let ϕ be, as in (5), the angle between a variable and a fixed meridian plane (say, that passing through the line of nodes), so that the kinetic energy is

$$T = \frac{1}{2}m' \{ \dot{r}^2 + r^2 \dot{\eta}^2 + r^2 \sin^2 \eta \cdot \dot{\phi}^2 \},$$

and let us quantize with respect to ϕ , η , r . Thus

$$\int_0^{2\pi} p_\phi d\phi = n_1 h, \quad \int_0^{2\pi} p_\eta d\eta = n_2 h, \quad \int p_r dr = \int_0^{2\pi} p_r \frac{dr}{d\theta} d\theta = n_3 h,$$

. . . (19)

where

$$p_\phi = m' r^2 \sin^2 \eta \cdot \dot{\phi}, \quad p_\eta = m' r^2 \dot{\eta}, \quad p_r = m' \dot{r}.$$

Remembering that $p = m' r^2 \dot{\theta}$, it will be seen at once that

$$p_\phi = p \cos i,$$

p_ϕ being simply the projection of p from the orbit plane upon the equatorial plane. Thus, both p and i being constant, the first of (19) gives simply $p \cos i = n_1 h / 2\pi$. The second and the third of (19) become at once, in virtue of the orbit equation (15), $2\pi p(1 - \cos i) = n_2 h$, and $2\pi p[(1 - \epsilon^2)^{-\frac{1}{2}} - 1] = n_3 h$, as in Sommerfeld's paper, the only difference (not affecting the value of the integral) being that θ is replaced by $\theta - \omega$. Thus the quantized values of the three elliptic elements are, in terms of the three independent integers appearing in (19),

$$p = (n_1 + n_2) \frac{h}{2\pi}, \quad \cos i = \frac{n_1}{n_1 + n_2}, \quad 1 - \epsilon^2 = \left(\frac{n_1 + n_2}{n_1 + n_2 + n_3} \right)^2.$$

. . . (20)

These are to be substituted in W_0 as well as in the expression (18) for \bar{F} . The sum of W_0 and \bar{F} will give the required W , as in (11).

Now, W_0 is easily found to be equal to $\kappa^2 \epsilon^4 m' (1 - \epsilon^2) / 2p^2$, and therefore, by (20), and with the previous meaning of R ,

$$W_0 = \frac{\kappa^2 R c h}{(n_1 + n_2 + n_3)^2},$$

while (18), with b as in (17), becomes, in virtue of the first of (20),

$$\bar{F} = \frac{3(\kappa^2 R c h)^3}{2\mu^2 (n_1 + n_2)^6} \left\{ \left[1 + \frac{3}{4} \epsilon^2 (1 + 2 \sin^2 \omega) \right] \sin^2 i - \left(\frac{2}{3} + \epsilon^2 \right) \right\}.$$

Let us still write

$$n = n_1 + n_2 + n_3.$$

Thus, ultimately, we shall have, for the total energy corresponding to any of the contemplated "stationary" orbits of the electron round the two-centres nucleus,

$$\frac{W}{ch} = \frac{\kappa^2 R}{n^2} \left\{ 1 - \gamma^2 \frac{n^2}{(n-n_3)^6} g^{(i, \epsilon)} \right\}, \quad \dots \quad (21)$$

where

$$\gamma = \frac{2\kappa Rcha}{e^2} \quad (\text{a pure number}), \quad \dots \quad (21.1)$$

$$g(i, \epsilon) = 1 + \frac{3}{2}\epsilon^2 - \frac{5}{2}\sin^2 i \cdot [1 + \frac{3}{4}\epsilon^2(1 + 2\sin^2 \omega)], \quad (21.2)$$

and, as in (20),

$$\cos i = \frac{n_1}{n_1 + n_2}, \quad \epsilon^2 = 1 - \left(\frac{n-n_3}{n} \right)^2. \quad \dots \quad (21.3)$$

The corresponding spectrum series being given by $\nu = \Delta W/ch$, it is not difficult to see the meaning of these formulæ.

If the two centres coincided ($a=0$), $\gamma=0$, and we should have an ordinary Balmerian series consisting of ideally sharp, simple lines, the three independent integers then appearing only through $n = n_1 + n_2 + n_3$, and their individual contributions being entirely irrelevant for the result.

Owing to the complexity of the nucleus, as here contemplated, there is a general shift of the spectrum, dependent on the numerical value of γ^2 , and, instead of a single sharp line (which would correspond to a given pair of initial and final n -values), there is a plurality of lines, some sharp, but most of finite breadth. Whether or not at least the general Balmerian type of the distribution of these *groups* of lines (as we may call all the lines corresponding to a fixed pair of initial and final n - or sum-values) will be preserved, will most essentially depend on the relative separation of the centres, that is, on the numerical value of γ . If γ^2 be but a very small fraction, we shall still have a Balmer series, although not of lines but of tightly packed groups, each group being a doublet or a triplet, etc., as the case may be, and each of their components consisting of several sub-components, sharp or broad,—in short, a Balmer series with fine structure of its members. But should γ^2 mount up to more conspicuous values, even the type of the series would be entirely modified, *i. e.*, as in the case of the spectra of most chemical elements, altogether different from the Balmerian type. Both possibilities seem interesting and, perhaps, promising.

A glance on the form of (21) and (21.2) will suffice to see that the splitting and the modification of the spectrum due to the asphericity of the nucleus are of an entirely different nature from the fine structure due to the relativistic complications, *i. e.* due to the variability of the electron's mass, as obtained in (the second part of) Sommerfeld's paper, cited above.

After these generalities let us return to formulæ (21), etc., with the purpose of discussing them in some detail. These formulæ seem to deserve some careful attention, the more so as their validity is by no means limited to a nucleus consisting of two isotropic centres (which would be a somewhat puerile assumption) but extends to a much larger class of cases, *viz.* to atomic systems with *any axially symmetrical nuclei*. In fact, the whole set of our formulæ will continue to hold in all such cases without any formal alterations whatever, the only difference being that a (appearing in γ) will have a different or rather a more general geometrical meaning. The exact meaning to be then attributed to a , which is not difficult to guess, will be explained in Section 5.

Thus, returning to the last set of formulæ, let us first note that whatever the length a characterizing an axially symmetric nucleus, it appears only through γ , (21.1), where it is divided by another, practically universal length. Let us estimate this length, *i. e.*

$$l = \frac{e^2}{Rch}, \text{ so that } \gamma = 2\kappa \frac{a}{l},$$

κ being always the number of e -charges contained in the whole nucleus. Now, in c.g.s. units, $e = 4.7 \cdot 10^{-10}$, $c = 3 \cdot 10^{10}$, $h = 6.5 \cdot 10^{-27}$, and the Rydberg "constant," even allowing for the slightly different values of m' as distinguished from m [*cf.* formula (2)], can safely be assumed to be always of the order $R = 1 \cdot 10 \cdot 10^5$. Thus,

$$l = 1.03 \cdot 10^{-8} \text{ cm.},$$

or almost just one Å.U. If, therefore we write, for convenience,

$$a = \alpha \text{ Å.U.},$$

the value of the coefficient in question will be

$$\gamma \doteq 2\kappa\alpha, \quad \dots \dots \dots (22)$$

which reads: γ equal to twice the number of Ångström units contained in a multiplied by the total number of electronic charges contained in the nucleus.

Now, α is certainly but a fraction (and the very validity

of the approximate perturbation method is based thereupon). But how small or how large this fraction may be, is difficult to say. If, for the moment, $2a$ is taken to be the diameter of the nucleus, then for the few gases involved in Rutherford's scattering experiments, a is certainly as small as 10^{-11} or 10^{-12} cm., that is to say, α of the order 10^{-3} or 10^{-4} *. But for other elements, and especially for the heavy ones, α may be much larger than this. Then, κ containing many units, γ may become quite a conspicuous fraction of unity. In short, there is a wide range of values which γ can assume. If it is near its lower limit we shall still have a Balmer series, although slightly shifted and with fine structure of its members; but if it mounts up, say to $\frac{1}{10}$ or only $\frac{1}{20}$, the very type of the series may cease altogether to resemble the Balmerian one. Within these wide limits, it would certainly be useless to attempt to prejudice the value of a or of γ for, say, the atoms of copper or of iron. On the contrary, one would have first to re-examine carefully and to try to disentangle the spectra of such elements and base the guesses about the appropriate value of γ , and thence of a , upon the observed features of their spectrum "series."

Having thus dealt sufficiently (for the present state of our knowledge) with the numerical aspect of the coefficient γ , let us pay some attention to the equation (21) itself, together with (21.2) and (21.3).

It may be well to write that equation in a form exhibiting directly the ratio of a to the dimensions of the orbit, so as to have before our eyes the assumption of its smallness, upon which the validity of the equation rests. Such a form is easily obtained when it is remembered that (21) is but the developed form of

$$\frac{W}{ch} = \frac{\kappa^2 R}{n^2} \left\{ 1 + \frac{\bar{F}}{W_0} \right\}.$$

Now, $W_0 = \kappa^2 e^4 m' (1 - \epsilon^2) / 2p^2$, and, as in (18), retaining the symbol $g(i, \epsilon)$,

$$\bar{F} = - \frac{\kappa^4 e^8 m'^3}{2p^6} a^2 g,$$

whence

$$\frac{\bar{F}}{W_0} = - \frac{\kappa^2 e^4 m'^2}{p^4} \cdot \frac{a^2 g}{1 - \epsilon^2}.$$

* If, as Sir E. Rutherford is inclined to assume, the mass of the nucleus (and therefore, practically, of the whole atom) is purely electromagnetic, then, for $\kappa=1$ say, a would be about $\frac{1}{2000}$ of the radius of an electron or $\alpha = \frac{1}{2} \cdot 10^{-16}$ cm., and therefore, $\alpha = \frac{1}{2} \cdot 10^{-8}$. But such an assumption is by no means necessary. There is, in fact, no evidence whatever for the existence of pure positive charges.

But, by the orbit equation (15), $p^2/\kappa\epsilon^2 m'$ is the parameter (latus rectum) of the orbit, i. e. $a(1-\epsilon^2)$, if a be the mean distance or the semimajor axis of the orbit*. Thus, the required form of (21),

$$\frac{W}{ch} = \frac{\kappa^2 R}{n^2} \left\{ 1 - \left(\frac{a}{\bar{a}}\right)^2 \frac{g(i, \epsilon)}{(1-\epsilon^2)^3} \right\}, \quad \dots \quad (21')$$

where g is as in (21.2). This shows us that for all not very eccentric orbits the supplementary term, due to anisotropy of nucleus, is of the order of $\left(\frac{a}{\bar{a}}\right)^2$, which is a fraction at any rate. At the same time we see that the coefficient γ has the simple geometrical meaning

$$\gamma = \frac{a}{\bar{a}} n^2. \quad \dots \quad (22a)$$

[This is a constant, as it should be; for, by (20), \bar{a} itself is proportional to n^2 . The last formula, coupled with (22), gives $2\kappa\alpha = \frac{a}{\bar{a}} n^2$, which contains the warning not to expect sufficient accuracy from our formulæ for those atoms for which the fraction $2\kappa\alpha$ may acquire a comparatively huge value.] From (21') we see also that even for small $\frac{a}{\bar{a}}$ the deviation of the series from the Balmer type can become dominant if the orbits are *strongly eccentric*, that is to say, when n_3 is a large number in comparison with $n_1 + n_2$.

Returning once more to formulæ (21), (21.2), (21.3), let us consider them in connexion with the various shapes and orientations of the orbits.

From the last set of these formulæ we see that all *meridian orbits* (i. e. those contained in any meridian plane, $\cos i = 0$) are given by

$$n_1 = 0;$$

the corresponding value of g is

$$g\left(\frac{\pi}{2}, \epsilon\right) = -\frac{1}{2} + \frac{3}{8}\epsilon^2(1 - 6\sin^2\omega), \quad \epsilon^2 = 1 - \frac{n_2^2}{(n_2 + n_3)^2}. \quad (M)$$

* Thus, the smallest non-vanishing value of p being $h/2\pi$, the smallest "stationary" orbit has the parameter or, if circular, the radius

$$a = \frac{1}{2\kappa} \frac{e^2}{Rch} = \frac{1.03}{2\kappa} 10^{-8} \text{ cm.},$$

inversely proportional to κ . It will be important to keep this well in mind, especially for the *heavier* atoms.

Of these only the circular orbits ($n_3 = n_1 = 0$), for which $g = -\frac{1}{2}$, will give rise to ideally *sharp* lines, forming series of the type

$$\nu = \kappa^2 R \left[\frac{1}{n'^2} \left(1 + \frac{\gamma^2}{2n'^4} \right) - \frac{1}{n^2} \left(1 + \frac{\gamma^2}{2n^4} \right) \right]. \quad (M_c)$$

The remaining elliptical orbits ($n_3 > 0$) will give rise to more or less *broad* lines; the greater the eccentricity, the broader the lines. The part of g responsible for this effect is

$$-\frac{9}{4} \epsilon^2 \sin^2 \omega,$$

ranging therefore, for the different individual atoms, from 0 to $-\frac{9\epsilon^2}{4}$.

All *equatorial orbits* ($i = 0$) are given by

$$n_2 = 0,$$

and the corresponding value of g being independent of the perihelion longitude,

$$g(0, \epsilon) = 1 + \frac{3}{2} \epsilon^2 = \frac{5}{2} - \frac{3n_1^2}{(n_1 + n_3)^2}, \quad \dots \quad (E)$$

all these orbits will give rise to *sharp* lines, no matter what their eccentricity. For the sub-class of circular orbits ($n_3 = n_2 = 0$) we shall have $g = 1$, so that the corresponding lines will form the series

$$\nu = \kappa^2 R \left[\frac{1}{n'^2} - \frac{1}{n^2} - \gamma^2 \left(\frac{1}{n'^6} - \frac{1}{n^6} \right) \right]. \quad \dots \quad (E_c)$$

Compare this with (M_c).

All *circular orbits* ($\epsilon = 0$), of any inclination, are given by

$$n_3 = 0.$$

The corresponding value of g being

$$g(i, 0) = 1 - \frac{3}{2} \sin^2 i = \frac{n_1(2n_1 - n_2) - nn_2}{2n^2}, \quad \dots \quad (C)$$

independent of the perihelion, all these orbits will give rise to *sharp* lines, of which, in general, a plurality will enter into one group. (Thus, for instance, if $n = n_1 + n_2 = 2$, we shall have, for $0 + 2$, $1 + 1$, $2 + 0$, the three possibilities $g = -\frac{1}{2}$ or $-\frac{1}{3}$ or $+1$, and for $n = 3$, $g = -\frac{1}{2}$, $-\frac{1}{3}$, $+\frac{1}{6}$ or $+1$, so that even the group 2, 3 would contain many "circular" components, so to call them shortly. Which of these are to be rejected as being more or less "improbable" is a further

question.) The energy belonging to any circular orbit is given by

$$\frac{W}{ch} = \frac{\kappa^2 R}{n^2} \left\{ 1 - \frac{\gamma^2}{n^4} g(i, 0) \right\} (C)$$

whence also the corresponding frequency formula.

The orbits responsible for *broad* "lines" or bands will be all those and those only for which both $\sin i$ and ϵ differ from zero, *i. e.*

$$n_2, n_3 \neq 0.$$

There is no harm in calling such orbits (diffuse or) *broad orbits**, and the remaining ones, sharp orbits. In this nomenclature the passage from a broad to a sharp orbit, or *vice versa*, will give rise to a line of finite breadth, and a band will be still broader if it is due to the passage from a broad to a broad orbit. If it is assumed, for instance, that, for any fixed ϵ, i , all the longitudes of the perihelion are equally probable (which need by no means be the case), then, the mean value of $\sin^2 \omega$ being $\frac{1}{2}$, the mean value of g will be, by (21.2),

$$\bar{g} = (1 + \frac{3}{2}\epsilon^2)(1 - \frac{3}{2}\sin^2 i), (23)$$

and its two extreme values, corresponding to $\sin \omega = 0$ and 1,

$$\bar{g} \pm \frac{9\epsilon^2}{8} \sin^2 i (23')$$

The mean energy belonging to a broad orbit will be obtained by substituting \bar{g} for g in (21), and the position of the centre of a band will be given by $\nu = (W' - \bar{W})/ch$, while the breadth of a band due to the passage from, say, a broad orbit (n) to a sharp orbit, will be given by

$$\delta\nu = \frac{9}{4} \frac{\kappa^2 R \gamma^2}{(n - n_3)^6} \epsilon^2 \sin^2 i, (24)$$

and similarly for the passage from a broad to a broad orbit by combining the appropriate extreme values of g and g' . In the case of an equatorial final orbit, for instance, (24) becomes, with $\gamma = 2\kappa\alpha$, as in (22),

$$\delta\nu = \frac{9\kappa^4 \alpha^2 R}{(n - n_3)^6} \epsilon^2 (24 e)$$

To form an idea of the numerical relations take, for example, $n = 3$, and the least eccentric orbit compatible with it, *i. e.* $n_3 = 1$, $\epsilon^2 = \frac{5}{9}$. Then

$$\delta\nu = \frac{5}{64} \kappa^4 \alpha^2 R \doteq 8600 \kappa^4 \alpha^2 \text{ cm.}^{-1},$$

* A "broad orbit" will thus stand for many orbits, all having the same α, i, ϵ , but all possible perihelion longitudes ω , from 0 to 2π , belonging to the individual atoms of the emitting substance.

and if, for instance, we require the breadth of the line to be $|\delta\lambda|=0.01 \text{ \AA.U.}$, to which corresponds in, say, the red region of the spectrum, $\delta\nu=0.023 \text{ cm.}^{-1}$, we should have

$$\kappa^2\alpha \doteq 0.0052,$$

that is to say, the value of a required to give such a line, $\frac{1}{100} \text{ \AA.U.}$ broad, would be

$$a \doteq \frac{5.2}{\kappa^2} 10^{-11} \text{ cm.},$$

i. e. for $\kappa=1$ (as in the case of hydrogen) $a=5.2 \cdot 10^{-11} \text{ cm.}$, and so on. Notice that the breadth of the line would, *ceteris paribus*, increase as $\kappa^4 a^2$. Thus, if we had, say, only $a \doteq 5 \cdot 10^{-12} \text{ cm.}$ for such atoms as those of uranium ($\kappa=92$) the "line" in question would be drawn out into a very broad band, in fact, a continuous spectrum extending over 7160 \AA.U. , and even $a=10^{-13}$ would still give a band stretching over little less than 3 \AA.U. And it will be kept in mind that in these heavier atoms larger a are more likely than in the light ones.

5. *Any axially symmetrical nucleus.* As has been already mentioned in the preceding Section, the set of formulæ (21) continues to hold for any axially symmetrical nucleus whatever. The reason is that the disturbing function V is for an atomic system with any such nucleus exactly of the form (13). The only difference is that the previous semi-distance a of the two centres acquires a more general meaning, and the whole expression may have one or the opposite sign according as the nucleus is "oblate" or "prolate," in a generalized sense of these words.

In fact, let the whole charge κe of the nucleus be distributed in any manner whatever over a volume τ . Let O be the "centre of mass" (electric analogue of ordinary mass-centre), and A, B, C the principal "moments of inertia" of the whole charge, each divided by the charge, *i. e.*, if x_1, y_1, z_1 be the coordinates of a charge element de along the principal axes, with O as origin, let

$$A = \frac{1}{\kappa e} \int (y_1^2 + z_1^2) de, \text{ etc. (25)}$$

Let the electron be at P , and let K be the "moment of inertia" of the nucleus about OP , divided by κe . Then, if $OP=r$ is large compared with the dimensions of the nucleus, the negative potential energy of the system will be, by a well-known result of the ordinary potential theory,

$$\kappa e^2 \left\{ \frac{1}{r} + \frac{1}{2r^3} (A + B + C - 3K) \right\}.$$

Thus our disturbing function F will be

$$F = \frac{\kappa e^2}{2r^3} (A + B + C - 3K).$$

Here A , B , C are constants, characterizing the nucleus, their dimensions being, by (25), those of a squared length, and K is a function of the orientation of OP with respect to the principal axes, to wit, if η_1 , η_2 , η_3 be the angles which OP makes with these axes, to which belong A , B , C respectively,

$$K = A \cos^2 \eta_1 + B \cos^2 \eta_2 + C \cos^2 \eta_3,$$

where, of course, $\cos^2 \eta_1 + \cos^2 \eta_2 + \cos^2 \eta_3 = 1$. Thus the disturbing function will be

$$F = \frac{\kappa e^2}{2r^3} \left\{ A(1 - 3 \cos^2 \eta_1) + B(1 - 3 \cos^2 \eta_2) + C(1 - 3 \cos^2 \eta_3) \right\}, \dots \quad (26)$$

for a nucleus of any shape and of any charge distribution whatever.

In particular, for any axially symmetrical nucleus, with say the A -axis as axis of symmetry, *i. e.* with $C = B$, and with η written for η_1 , the disturbing function of the atomic system becomes at once

$$F = \frac{\kappa e^2}{2r^3} (B - A) (3 \cos^2 \eta - 1),$$

which is exactly of the form (13), the squared semi-distance of the two centres, a^2 , being here replaced by

$$B - A.$$

Thus, as was announced, the set of formulæ (21), etc. continues to hold for any axially symmetrical nucleus. If $B > A$, we will say, shortly, that the nucleus is "prolate," and if $A > B$, that it is "oblate" (for such it would be in the ordinary geometrical sense of the words if its charge were, for instance, uniformly distributed). In view of these two possibilities, affecting the sign of the perturbational term, it will be better to rewrite here the generalized equation (21), thus

$$\frac{W}{ch} = \frac{\kappa^2 R}{n^2} \left\{ 1 \pm \gamma^2 \frac{n^2 g(i, \epsilon)}{(n - n_3)^6} \right\}, \dots \quad (28)$$

where
$$\gamma = \frac{2\kappa Rch}{e^2} |A - B|^{1/2}, \dots \quad (28.1)$$

the positive sign to be taken for an *oblate*, and the negative

sign for a prolate nucleus*. The value of $g(i, \epsilon)$ is still as in (21.2), with (21.3).

This set of formulæ determines the spectra corresponding to large electronic orbits round any axially symmetrical nucleus.

If, for instance, the nucleus be a homogeneous rotational ellipsoid of semi-axes a and b (the former being the axis of symmetry), then $A = \frac{2}{3}b^2$ and $B = \frac{1}{5}(a^2 + b^2)$, so that

$$|A - B| = \frac{1}{5}|a^2 - b^2|.$$

If this ellipsoid be oblate, and if ζ be the eccentricity of its generating ellipse, then

$$\gamma = \frac{2\kappa Rch}{e^2} \cdot \frac{b\zeta}{\sqrt{5}},$$

so that our previous a is to be replaced by $b\zeta/\sqrt{5}$, and the positive sign is to be taken in (28). And if it be a prolate ellipsoid then a is to be replaced by $a\zeta/\sqrt{5}$, and the negative sign is to be taken. In either case the effect on the spectrum is seen to be, *ceteris paribus*, proportional to ζ^2 .

6. *Nucleus of any shape.* In the most general case the disturbing function is given by (26). The coefficients A, B, C being all different from one another, the longitude of the node Ω , hitherto irrelevant and physically meaningless, comes to its rights and, in addition to the perihelion, becomes a fresh source of broadening of the spectrum lines. For, as in the case of ω , there is no way of quantizing the longitude of the node.

If the orbit is written as in (15), if i be the inclination of the orbit to the BC -plane (so that η_1 becomes our previous η), and if the longitude Ω of the ascending node be counted from the B -axis, we have

$$\cos \eta_1 = \sin i \sin \theta,$$

$$\cos \eta_2 = \cos \theta \cos \Omega - \sin \theta \sin \Omega \cos i,$$

$$\cos \eta_3 = \cos \theta \sin \Omega + \sin \theta \cos \Omega \cos i.$$

These values are to be substituted into (26). It will, for the present, be enough to write down the result for the case in which all node longitudes are equally distributed among the atoms. Then a term containing $\sin 2\Omega$ disappears in the

* The previous two centres formed, of course, a nucleus of the latter kind.

average taken over all atoms, and the relevant part of the disturbing function F is given by

$$\frac{2r^3}{3\kappa e^2} F = [B \cos^2 \Omega + C \sin^2 \Omega - (B \sin^2 \Omega + C \cos^2 \Omega) \cos^2 i - A \sin^2 i] \sin^2 \theta + \frac{1}{3}(A + B + C) - (B \cos^2 \Omega + C \sin^2 \Omega). \quad (29)$$

If, keeping in mind the finite breadth of the lines due to Ω , we desire only to deal with the position of the centres of these "lines" or bands, then it is enough to retain the average of F taken over all emitting atoms, which we may denote by F_s . It is manifestly legitimate to take first this average, and then the average, $\overline{F_s}$, over a period of the undisturbed motion. Thus (29) reduces at once to

$$F_s = \frac{\kappa e^2}{4} \cdot \frac{B + C - 2A}{r^3} (3 \sin^2 i \sin^2 \theta - 1), \quad (29 s)$$

which is exactly of the same form as (13), with a^2 replaced by $\frac{1}{2}(B + C) - A$.

Thus, taking the time average, the corresponding energy will again be given by (28), with the only difference that the coefficient γ , (28.1), will now be replaced by the more general one,

$$\gamma = \frac{2\kappa Rch}{e^2} \left| A - \frac{1}{2}(B + C) \right|^{1/2}.$$

The value of $g(i, \epsilon)$ will still be as in (21.2), and the eccentricity ϵ will, manifestly, be quantized as before. It remains, however, to see whether i , the inclination*, does not now in this respect behave differently.

Returning to equations (19) and to what immediately followed upon them, we shall see that the only difference is that the relation $\tan \phi = \tan \theta \cdot \cos i$ has now to be replaced by

$$\tan(\phi - \Omega) = \tan \theta \cdot \cos i.$$

This, however, does not affect the results. The geometrically obvious relation

$$p_\phi = p \cos i$$

continues to hold, and therefore $p \cos i = n_1 h / 2\pi$. And since

* It will be remembered that i was taken with reference to the BC -plane, and this is the reason why A is privileged in the last two or three formulæ.

p_n is as before, we have also $2\pi(1 - \cos i) = n_2 h$. In short, all the equations (20), including

$$\cos i = \frac{n_1}{n_1 + n_2},$$

retain their validity.

Thus $g(i, \epsilon)$ is, also in terms of the integers n_1, n_2, n_3 , exactly as before. But with equal right as BC we could have taken CA or AB as reference planes for the inclination, and every time i would be quantized in exactly the same way. Thus, the asymmetry of the nucleus gives rise to new "stationary" orbits and, therefore, to new spectrum lines or bands. Ultimately, therefore, we shall have for the determination of the centres of the bands, writing W_s instead of W in (28), the equation

$$\frac{W_s}{ch} = \frac{\kappa^2 R}{n^2} \left\{ 1 \pm \gamma^2 \frac{n^2 \bar{g}}{(n - n_3)^6} \right\}, \dots (30)$$

where $\bar{g} = g_s = (1 + \frac{3}{2}\epsilon^2)(1 - \frac{3}{2}\sin^2 i), \dots (30\cdot1)$

with ϵ, i as in (20), and where γ has any of the three values

$$\frac{e^2}{2\kappa Rch} \gamma = \left| A - \frac{1}{2}(B + C) \right|^{1/2}, \quad \left| B - \frac{1}{2}(C + A) \right|^{1/2}, \\ \left| C - \frac{1}{2}(A + B) \right|^{1/2}. \dots (30\cdot2)$$

The positive or the negative sign is to be taken in (30), according as A is greater or smaller than $\frac{1}{2}(B + C)$, and similarly for the remaining two values of γ .

Thus the spectrum belonging to a nucleus without any axis of symmetry would be much richer in lines or components than that of an axially symmetrical nucleus, for which we have had only, as in (28\cdot1),

$$\left| A - B \right|^{1/2}$$

instead of the three values in (30\cdot2). But looking back upon that case from the point of view of the present more general case, *i. e.*: putting in (30\cdot2) $C = B$, we should have for an axially symmetric nucleus not only the previously described lines or "components" but also those corresponding to

$$\frac{e^2 \gamma}{2\kappa Rch} = \left| \frac{1}{2}(B - A) \right|^{1/2}, \dots (28\cdot1')$$

with (30) and (30\cdot1). In fact, the former lines were obtained by taking the equatorial plane as the plane $i = 0$, and the reason was that this (or its normal, the axis of

symmetry) was uniquely privileged. But from the present, more general point of view there is certainly no reason for rejecting a meridian plane as the reference plane ($i=0$), and this, *i.e.* any such reference plane, will precisely give, in addition to (28·1) the new coefficient (28·1') and thus also new lines or components.

Still, the asymmetric nucleus will be richer in possible lines or components. Which of these are to be rejected, can be decided only on the ground of spectroscopic experience. One might put forward, for instance, as a restricting criterion that out of the three γ -values (30·2), that only is to be retained to which, *ceteris paribus*, corresponds the greatest W_s , or perhaps the smallest W_s , or what not. But all such guesswork, unsupported by observation, would be pretty useless.

The chief purpose of the present paper has been to show the numerous and broad possibilities opened up by a non-spherical nucleus both with regard to the fine structure of lines or groups and to the very type of the spectrum series. All numerical applications of the general formulæ and their discussion in connexion with experimental spectroscopic knowledge are necessarily postponed to a later opportunity.

Research Dept., Adam Hilger.
London, October 18, 1919.

VI. *The Calculation of Radiation emitted in Gaseous Explosions from the Pressure-Time Curves.* By Major W. T. DAVID, M.A., M.Sc.*

INTRODUCTION.

1. **I**N this paper an attempt is made to build up formulæ by means of which the radiation emitted in explosions of inflammable mixtures of coal-gas and air may be calculated from the pressure-time curves. A large number of photographic films on which were traced curves of pressure and of radiation emitted † have been examined, and it has been found possible to establish some simple equations which would seem to apply within fairly wide limits of mixture strength, density, and volume.

* Communicated by the Author.

† Curves taken from a considerable number of these films have previously been published in the Phil. Trans. (A. vol. cxxi. pp. 375-410). Reference should be made to this paper for full details of the experimental methods employed.

2. It will be convenient to describe here very briefly the experimental arrangements under which these films were taken. The gaseous mixtures were exploded in a cylindrical cast-iron vessel 30 cm. in diameter and 30 cm. in length (shown in fig. 1). The pressures of the gaseous mixtures

Fig. 1.

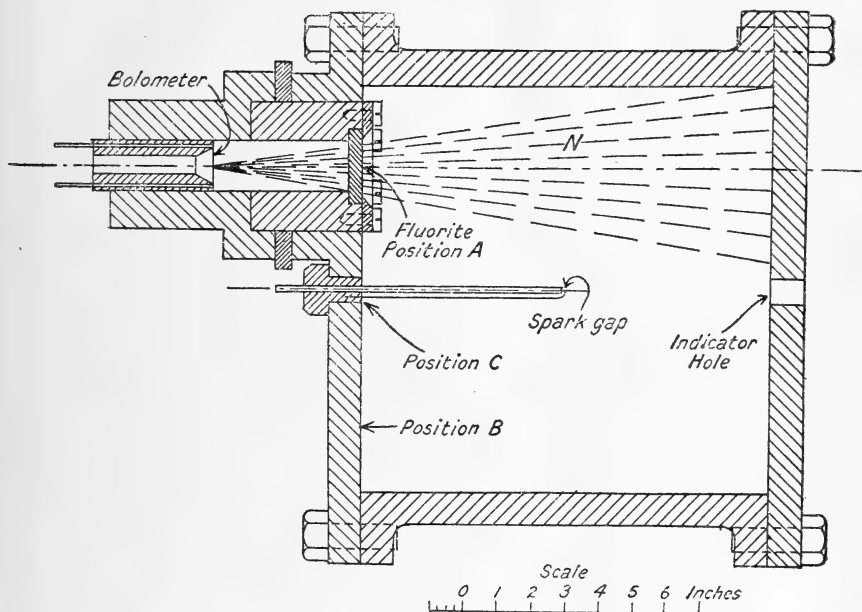

during explosion and subsequent cooling were measured by means of a Hopkinson optical indicator which threw a spot of light on to a revolving photographic film. The radiation was measured by means of a platinum bolometer connected with a reflecting galvanometer which also threw a spot of light on to the same revolving film. The bolometer was protected from the hot gaseous mixture by means of a plate of fluorite as shown in fig. 1. The fluorite transmits almost exactly 95 per cent. of radiation of the wave-length emitted by an exploded coal-gas and air mixture. After making an allowance of 5 per cent. for the absorption of the fluorite and 5 per cent. for reflexion from the blackened surface of the bolometer, it is considered that the measurements from the films give radiation values of a high degree of accuracy.

3. The radiation emitted was measured in three positions on one of the end-curves of the explosion vessel, viz. at the top (position A), at the bottom (position B), and at the centre (position C). The radiation measured at position C was a little greater than that at either A or B; and that measured at A was a little greater than that at B. The mean value of the radiation received at A, B, and C gives a fairly accurate estimate of the average radiation over the whole vessel.

4. When the bolometer was placed close up to the window of fluorite the radiation it received per sq. cm. of its surface was equal to that received by a sq. cm. of wall surface in the immediate neighbourhood; and when the bolometer was placed some distance away from the fluorite plate the radiation it received came from a cone of the gaseous mixture of small solid angle (N , as shown in fig. 1). Throughout this paper the radiation measured with the bolometer in the latter position has been divided by the solid angle of the cone so as to give the radiation from a cone of unit solid angle. The rate of emission from a cone of gaseous mixture of unit solid angle has been called by Prof. Callendar the *intrinsic radiance*.

Fig. 2.

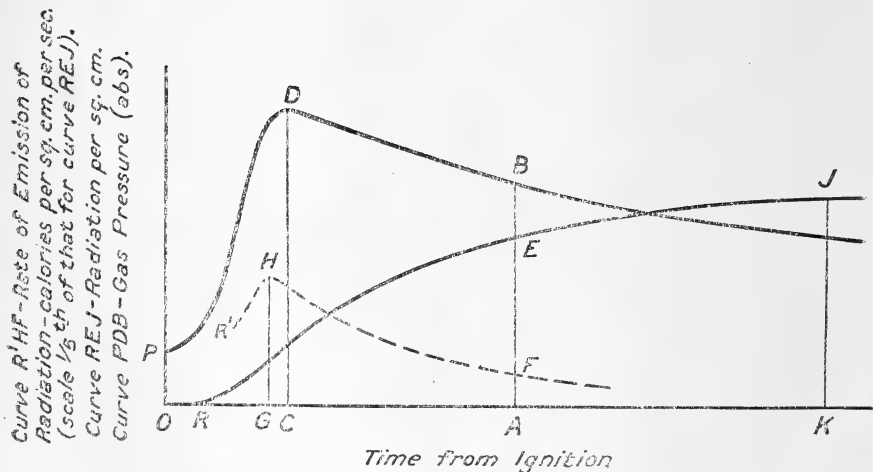

5. A list of the symbols used in this paper is given below. In defining them it will be convenient to refer to the curves in fig. 2, which have been taken from a typical record.

- t —time from ignition (OA).
 t_e —time of explosion (OC), *i. e.* time taken by gaseous mixture to develop its maximum pressure.
 p —pressure of gaseous mixture at time t in lb. per sq. in. (abs.) (AB).
 $p_{\max.}$ —maximum pressure (CD).
 \dot{p} —rate of change of pressure at time t .
 $\dot{p}_{\max.}$ —the maximum rate of change of pressure (which occurs during the explosion period).
 θ —mean absolute temperature in $^{\circ}\text{C}$. of the gaseous mixture at time t calculated from the pressure curve by means of the equation $pv = R\theta$ after making a small correction (of the order of 3 per cent.) for contraction of volume which occurs on the combustion of the coal-gas.
 $\theta_{\max.}$ —maximum mean absolute temperature developed in the gaseous mixture.
 $\dot{\theta}$ —rate of change of mean gas temperature at time t .
 $\dot{\theta}_{\max.}$ —maximum rate of change of mean gas temperature (which occurs during the explosion period).
 Q —quantity of coal-gas present in explosion vessel (measured in litres at atmospheric temperature and pressure).
 v —volume of cylindrical vessel in c.c. of dimensions l cm. diameter and l cm. long = $\frac{\pi}{4}l^3$. (In the explosion vessel used in the experiments $l=30$.)
 a —area of interior surface of vessel in sq. cm. (In the explosion vessel used in the experiments $a=4380$ sq. cm.)
 D —density of gaseous mixture in atmospheres.
 R —total radiation received by walls of explosion vessel per sq. cm. of surface at time t measured in calories (AE, when bolometer is close up to fluorite window).
 R_T —final value of R , *i. e.* the value of R registered after a time when the gaseous mixture has cooled to such an extent that it emits no further radiation (KJ). For all practical purposes this is the radiation registered at 1 sec. after ignition, for after this time the radiation emitted was insignificant.

- \dot{R} —differential coefficient of R with respect to t , *i. e.* the rate at which the walls receive radiation per sq. cm. of surface (AF).
- \dot{R}_{\max} —the maximum rate at which the walls receive radiation per sq. cm. of surface (HG). This takes place during the explosion period.
- R_t —total radiation at time t received by the bolometer per sq. cm. of its surface from a cone of gaseous mixture of unit solid angle (AE, when bolometer is some distance away from fluorite window).
- R_{iT} —final value of R_i , *i. e.* the value of R_i registered after a time when the gaseous mixture has cooled to such an extent that it emits no further radiation (KJ). For all practical purposes this is the value of R_i registered at 1 second after ignition.
- \dot{R}_i —differential coefficient of R_i with respect to t . This is the intrinsic radiance (AF).
- $\dot{R}_{i\max}$ —the maximum value of \dot{R}_i which occurs during the explosion period (HG).

THE MAXIMUM RATE OF EMISSION OF RADIATION DURING EXPLOSION.

(a) *Cylindrical Explosion Vessel 30 cm. diameter and 30 cm. long.*

6. It has previously been shown* that the rate at which the gaseous mixture emits radiation is a maximum some little time before the attainment of maximum pressure. From an examination of a large number of films it would appear that the maximum rate of emission occurs at or near the second point of inflexion in the pressure curve during the explosion period. The curves in fig. 3 have been taken from three typical films. The A curves relate to a 10.5 per cent. mixture of coal-gas and air at atmospheric density; the B curves to a 10.2 per cent. mixture at 1.24 atmospheres density; and the C curves to a 9.2 per cent. mixture at 1.37 atmospheres density†. The dotted curves are the differentials of the radiation curves, and they show clearly that the maximum rate of emission occurs near the time when the gas-pressure or temperature curves undergo their second

* Phil. Trans. A. vol. cexi. p. 381.

† All the gaseous mixtures referred to in this paper were originally at atmospheric temperature.

inflexion, which, of course, takes place immediately after the period during which the rate of rise of gas pressure or temperature is a maximum.

Fig. 3.

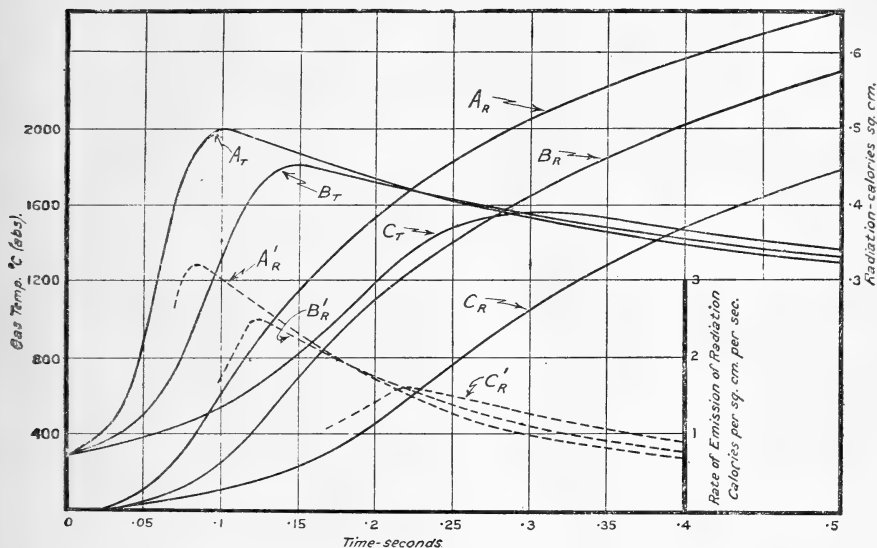

- A curves : 10.5 % mixture of coal-gas and air at atmospheric density.
 B curves : 10.2 % mixture of coal-gas and air at 1.24 atmospheres density.
 C curves : 9.2 % mixture of coal-gas and air at 1.37 atmospheres density.

7. It occurred to the writer, therefore, to make an attempt to connect the maximum rate of emission ($\dot{R}_{\max.}$) with the maximum rate of rise of pressure ($\dot{p}_{\max.}$) or of temperature ($\dot{\theta}_{\max.}$), and it was discovered that for mixtures containing the same quantity (Q) of coal-gas $\dot{R}_{\max.}$ was proportional to the square root of $\dot{\theta}_{\max.}$. This will be seen on comparing columns 1 and 9 in Table I. It will be noticed that the ratio

$\frac{\dot{R}_{\max.}}{\sqrt{\dot{\theta}_{\max.}}}$ is practically the same in all cases where Q has the

same value. Further, this ratio increases as Q increases and it seems to be very approximately proportional to the square root of Q . The figures in column 10 are the ratios of the figures in column 9 to \sqrt{Q} —*i. e.* they are the ratio

$$\frac{\dot{R}_{\max.}}{\sqrt{Q} \times \sqrt{\dot{\theta}_{\max.}}}$$

TABLE I.

Q (litres).	Percent. strength of mixture.	D (atmosphere).	\sqrt{Q} .	$\dot{p}_{\max.}$ (lb. per sq. in. per sec.)	$\dot{\theta}_{\max.}$ (° C. per sec.)	$\sqrt{\dot{\theta}_{\max.}}$	$\dot{R}_{\max.}$	$\frac{\dot{R}_{\max.}}{\sqrt{\dot{\theta}_{\max.}}}$	$\frac{\dot{R}_{\max.}}{\sqrt{Q \times \dot{\theta}_{\max.}}}$
1.67	15.0	0.5	1.29	1800	7.1×10^4	2.66×10^2	3.2	1.2×10^{-2}	0.93×10^{-2}
2.21	9.85	1.0	1.49	800	1.37	1.25	1.9	1.5	1.00
2.32	10.45	1.0	1.53	1900	3.72	1.93	3.2	1.6	1.04
2.77	16.7	0.75	1.67	3480	9.12	3.02	4.6	1.5	0.90
2.80	12.5	1.0	1.67	2920	5.72	2.40	4.0	1.7	1.02
2.80	11.2	1.13	1.67	2230	3.88	1.97	3.1	1.6	0.96
2.80	10.2	1.24	1.67	1290	2.40	1.55	2.5	1.6	0.96
2.80	9.2	1.38	1.67	520	0.74	0.86	1.5	1.8	1.08
3.34	15.0	*1.0	1.83	3640	7.14	2.67	5.4	2.0	1.09
3.37	12.2	1.23	1.84	3560	5.66	2.38	4.6	2.0	1.08
3.37	10.0	1.52	1.84	1550	2.00	1.41	2.8	2.0	1.08
5.02	15.0	1.50	2.26	5880	7.72	2.78	6.3	2.3	1.02
Mean									1.00×10^{-2}

for the various mixtures (which it should be noticed vary in density as well as in strength). These ratios are all pretty much the same—indeed, having regard to the large variations in $\dot{R}_{\max.}$, $\dot{\theta}_{\max.}$, Q , and D it is somewhat surprising to find them agree with one another so closely.

8. It would therefore appear that certainly within the limits of mixture strength 9.2 per cent. to 15 per cent.* and of density $\frac{1}{2}$ atmosphere to a little over $1\frac{1}{2}$ atmospheres (as shown in Table I.) $\dot{R}_{\max.}$ in the explosion vessel used in the experiments is proportional to the square root of the product $Q \times \dot{\theta}_{\max.}$. Expressed in the form of an equation

$$\dot{R}_{\max.} = K\sqrt{Q \times \dot{\theta}_{\max.}}, \dots \dots \dots (1)$$

where K is a constant equal to 1.0×10^{-2} or 0.01, *i. e.* the mean value of the figures in column 10.

It may be noticed that as $\dot{\theta}$ is proportional to $\frac{\dot{p}}{D}$ (the ratio $\frac{\dot{\theta} \times D}{\dot{p}}$ being equal to 19.6) this equation may be written

$$\dot{R}_{\max.} = K_1\sqrt{\frac{Q \times \dot{p}_{\max.}}{D}}, \dots \dots \dots (2)$$

where $K_1 = 0.01 \times \sqrt{19.6} = 0.0445$.

9. Some confirmation is lent to the proportionality between $\dot{R}_{\max.}$ and $\sqrt{Q \times \dot{\theta}_{\max.}}$ from the writer's measurements of the intrinsic radiance of coal-gas and air mixtures at various densities from $\frac{1}{2}$ atmosphere to $1\frac{1}{4}$ atmospheres †. These are set out in Table II. (which contains similar information to that given in Table I.). It will be noticed that the ratios in column 10 are again very much the same, though of course they differ from those in column 10 in Table I. because the values of $\dot{R}_{i \max.}$ are different from those of $\dot{R}_{\max.}$. The equations for the maximum intrinsic radiance are therefore

$$\dot{R}_{i \max.} = 0.0117\sqrt{Q \times \dot{\theta}_{\max.}}, \dots \dots \dots (3)$$

and
$$\dot{R}_{i \max.} = 0.052\sqrt{\frac{Q \times \dot{p}_{\max.}}{D}}, \dots \dots \dots (4)$$

* A 15 per cent. mixture is the strongest that will burn completely—*i. e.* it uses up the whole of the oxygen of the air. The weakest mixture that will explode is probably between 7 per cent. and 8 per cent. The limits of mixture strength in these experiments are therefore very wide.

† Phil. Trans. A. vol. cccx. p. 395.

TABLE II.

Q (litres).	Percent. strength of mixture.	D (atmosphere).	\sqrt{Q} .	$\dot{p}_{\max.}$ (lb. per sq. in. per sec.)	$\dot{\theta}_{\max.}$ (°C. per sec.)	$\sqrt{\dot{\theta}_{\max.}}$	$\dot{R}_i \max.$	$\frac{\dot{R}_i \max.}{\sqrt{\dot{\theta}_{\max.}}}$	$\frac{\dot{R}_i \max.}{\sqrt{Q \times \dot{\theta}_{\max.}}}$
1.67	15.0	0.5	1.29	1600	6.27×10^4	2.50×10^2	3.8	1.5×10^{-2}	1.16×10^{-2}
2.52	15.0	0.75	1.59	3480	9.12	3.20	5.6	1.8	1.13
2.92	13.0	1.0	1.71	2760	5.42	2.35	4.7	2.0	1.17
3.34	15.0	1.0	1.83	4500	8.80	2.97	6.5	2.2	1.20
4.19	15.0	1.25	2.05	4880	7.60	2.76	7.2	2.6	1.27
Mean									1.17×10^{-2}

10. In considering these formulæ it is suggestive to regard Q as being proportional to the density of distribution of chemical energy in the inflammable mixture and $\dot{\theta}$ as being proportional to the rate of conversion of chemical energy into thermal energy. In a previous paper it has been suggested that the chemical energy in process of conversion first passes (either wholly or a considerable proportion of it) into the form of internal vibrations of the combining molecules, and it is reasonable to suppose that the radiation to which these vibrations give rise and which comes from the whole mass of the burning gas should be a maximum towards the end of the period during which combustion proceeds at its maximum rate.

(b) *Cylindrical Explosion Vessel l cm. diameter
and l cm. long.*

11. It will be realized that the radiation values in the preceding sections have referred to explosions in a single vessel 30 cm. in diameter and 30 cm. long. Some indication of the effect of size of vessel on the radiation values may, however, be obtained from the writer's experiments on the diathermancy of coal-gas and air mixtures exploded in a vessel with silver-plated walls which could be made reflecting by polishing or absorbent as regards radiation received by them by coating with a thin layer of dull black paint*.

12. In fig. 4 an attempt is made to plot \dot{R}_i (which is proportional to $\dot{R}_{i \max.}$) for mixtures of various densities for a cylindrical vessel l cm. diameter and l cm. long against l . Confine the attention first to the thick curve which connects \dot{R}_i with l for a 15 per cent. mixture at atmospheric density. The value for $l=30$ (viz. 6.6 calories per sq. cm. per sec.) is, of course, directly obtained from the experiments, for the cylindrical vessel used in these experiments was of dimensions 30 cm. by 30 cm. It is clear, too, that $\dot{R}_i=0$ for $l=0$, so that there are two definite points on the curve. Two other points, one for $l=15$ and the other for $l=59$, may be roughly fixed in the light of the following considerations. That for $l=59$ will certainly lie somewhere between \dot{R}_i for 59 cm. in the polished vessel (which is 10.9) and \dot{R}_i for 59 cm. in the blackened vessel (which is 8.4)

* Phil. Trans. A. vol. cexi. p. 395.

and probably will lie rather nearer the latter*. The other for $l=15$ will in all probability lie between $\dot{R}_{i \max}$ from 15 cm. in the blackened vessel (which is 4.7) and half that from 30 cm. in the blackened vessel (which amounts to 3.3) †.

Fig. 4.

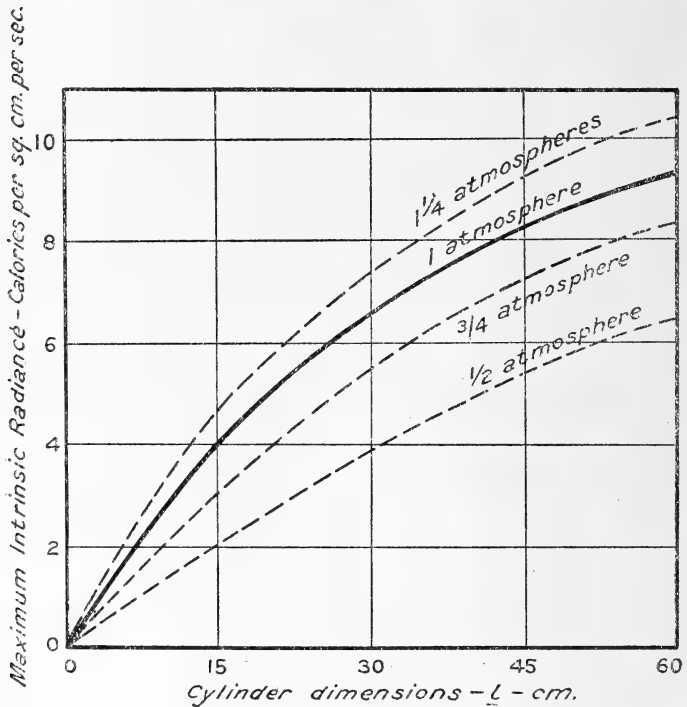

‡ The thick line then is a fair curve drawn through the two definite points (0, 0) and (30, 6.6) and between the two pairs of points (15, 3.3–4.7) and (59, 8.4–10.9).

* There seems little doubt that the radiation from a layer of gas increases not only with its thickness but with its lateral dimensions as well. The radiation from a cylindrical mass of gas 59 cm. \times 59 cm. will therefore be greater than that from a cylindrical mass 59 cm. long and 30 cm. in diameter. On the other hand, the radiation from 59 cm. in the polished vessel approximates to that from a mass of gas 59 cm. in thickness but of infinite lateral dimensions.

† $\dot{R}_{i \max}$ from 15 cm. in the blackened vessel will be greater than that from a cylindrical mass 15 cm. by 15 cm., because in the former case the lateral dimensions are greater than in the latter.

The dotted curves relate to 15 per cent. mixtures at $\frac{1}{2}$ atmosphere, $\frac{3}{4}$ atmosphere, and $1\frac{1}{4}$ atmospheres density, and they have been drawn from similar data.

It is not suggested that these curves give a very accurate relationship between $\dot{R}_{i \max.}$ and cylinder dimensions, but it is considered that they give a very definite indication of the shape of the true curves.

13. These curves (with the exception of that for $\frac{1}{2}$ atmosphere density) indicate that $\dot{R}_{i \max.}$ (and therefore $\dot{R}_{\max.}$) varies more or less as \sqrt{l} . The curve for $\frac{1}{2}$ atmosphere density is practically a straight line up to $l=30$. This seems reasonable in view of the known higher transparency of the gaseous mixture at this density.

Assuming the relationship $\dot{R}_{\max.} \propto \sqrt{l}$ to be reasonably near the truth, equations (1) and (2) may be amended to cover varying volume in the following way:—

$$\begin{aligned} \dot{R}_{\max.} &= 0.01 \sqrt{\frac{l}{30}} \sqrt{Q \times \dot{\theta}_{\max.}} \\ &= 0.00183 \sqrt{l \times Q \times \dot{\theta}_{\max.}} \dots \dots (5) \end{aligned}$$

And equations (2), (3), and (4) will become—

$$\dot{R}_{\max.} = 0.00812 \sqrt{\frac{l \times Q \times \dot{p}_{\max.}}{D}} \dots \dots (6)$$

$$\dot{R}_{i \max.} = 0.00214 \sqrt{l \times Q \times \dot{\theta}_{\max.}} \dots \dots (7)$$

$$\dot{R}_{i \max.} = 0.0095 \sqrt{\frac{l \times Q \times \dot{p}_{\max.}}{D}} \dots \dots (8)$$

14. These equations it is thought may be expected to give values for $\dot{R}_{\max.}$ and $\dot{R}_{i \max.}$ correct to within perhaps 10 per cent. when applied to mixtures of coal-gas and air ranging from 9 to 15 per cent., within the limits of density $\frac{3}{4}$ atmosphere to perhaps $1\frac{1}{2}$ or 2 atmospheres and within the limits of cylinder dimensions 15 cm. \times 15 cm. to 60 cm. \times 60 cm.

Further experimental work will be required in order to decide whether they apply approximately outside these limits.

RATE OF EMISSION OF RADIATION DURING COOLING.

(a) *Cylindrical Explosion Vessel 30 cm. diameter and 30 cm. long. Gaseous Mixtures at Atmospheric Density.*

15. It is not possible to build up an accurate formula for \dot{R} at any temperature under wide conditions of mixture strength, density, and volume until much further experimental work is accomplished. The whole question is complicated greatly by the fact that the transparency of the gaseous mixture varies with the time after ignition, and also (to a much less extent) because the vibratory energy of the molecules is dependent upon other factors as well as temperature*. It is important, however, from the point of view of gas-engine calculations to be able to estimate the radiation loss at various points during the expansion stroke, and it is believed that an empirical formula sufficiently accurate for this purpose can be established.

16. It has been previously shown that the radiation from the gaseous mixture when corrected for absorption varies with the temperature approximately in accordance with Planck's formula for a wave-length of 3.6μ † (which at high temperatures varies very nearly as the square of the absolute temperature). It so happens, however, that when uncorrected for absorption \dot{R} in a vessel of the dimensions used in the experiments is approximately proportional to θ^4 , and it is considered that a formula based upon this law will give gas-engine designers fairly reliable information as to radiation loss when applied to cylinders within the limits of dimensions 15 cm. \times 15 cm. to 60 cm. \times 60 cm. ‡

* See Phil. Mag. Feb. 1913, p. 267.

† Phil. Trans. A. vol. cexi. p. 402.

‡ See Phil. Trans. p. 386, fig. 9. The θ^4 curve there was made to coincide with \dot{R} at comparatively low gas temperatures when the radiation is small. By increasing the scale a close agreement may be obtained at the high temperatures (2400° C. abs. to 1600° C. abs.), which is the important part of the curve from the point of view of the gas-engine. The agreement between the θ^4 curve and \dot{R} in the neighbourhood of the maximum temperature in the 9.8 per cent. mixture is not so good, but a fairly correct value for \dot{R} in this epoch for weak mixtures may be obtained by calculating the mean of \dot{R} given by the θ^4 formula (equation (9) § 17) and \dot{R}_{max} as determined by the equation in the preceding sections.

The statement made in the paper referred to (footnote p. 402) to the effect that the θ^4 law would not hold in the case of a cylinder of widely different dimensions from those of the vessel used in the experiments requires some modification. There seems little doubt that this statement

17. In a vessel 30 cm. in diameter and 30 cm. in length

$$\dot{R} = 1.75 \times 10^{-14} \theta^4, \quad \dots \dots \dots (9)$$

where the constant 1.75×10^{-14} has been determined from the writer's experiments*.

(b) *Effect of Density and of Cylinder Dimensions.*

18. These experiments also indicate that \dot{R} varies as $\sqrt{D}\dagger$, and as we have seen in § 13 of this paper it also varies as \sqrt{l} .

In order to cover density and cylinder dimensions equation (9) thus becomes

$$\begin{aligned} \dot{R} &= 1.75 \times 10^{-14} \theta^4 \sqrt{D} \sqrt{\frac{l}{30}} \\ &= 0.32 \times 10^{-14} \theta^4 \sqrt{l \times D}. \quad \dots \dots \dots (10) \end{aligned}$$

19. This equation has been used to calculate \dot{R} in a large number of cases for the vessel 30 cm. by 30 cm. within the limits of mixture strength 9.2 to 15 per cent. and of density $\frac{1}{2}$ atmosphere to $1\frac{1}{2}$ atmospheres, and it has been found that the calculated value agrees with the observed value to within 15 per cent.

20. It will be clear that equations (1) to (10) apply only in the case of a cylindrical vessel whose length is equal to its diameter. In a gas-engine, however, the length varies throughout the stroke, and some modification of these equations is necessary in order that they may be applied directly to gas-engine calculations. This problem will be considered in another paper.

is true in the case of a vessel whose length is varied but whose diameter remains fixed at 30 cm. (Compare curves C and D, fig. 14, p. 396.) When, however, the diameter is varied in the same proportion as the length it is probable that, owing to the fact that the transparency varies with the lateral dimensions, \dot{R} would more or less follow the θ^4 law. (Compare curves A and D in the same figure. The former gives the intrinsic radiance for a cylindrical mass of gas of effective length 59 cm. and of effective diameter greater than 59 cm., while the latter gives the intrinsic radiance for a cylindrical mass 30 cm. in diameter and 30 cm. long. Both curves follow the θ^4 law approximately.)

* Phil. Trans. A. vol. cxxi. p. 386, fig. 9.

† Phil. Trans. A. vol. cxxi. pp. 388 & 405.

TOTAL RADIATION EMITTED DURING EXPLOSION AND
SUBSEQUENT COOLING.

(a) *Cylindrical Vessel 30 cm. diameter and 30 cm. long ;
Gaseous Mixtures at Atmospheric Density.*

21. In fig. 5 are given mean gas temperature curves and total radiation curves per sq. cm. of wall surface for mixtures of coal-gas and air of atmospheric density varying in strength from 9.7 per cent. to 15 per cent. The radiation curves were all taken when the bolometer was in position C, in which

Fig. 5.

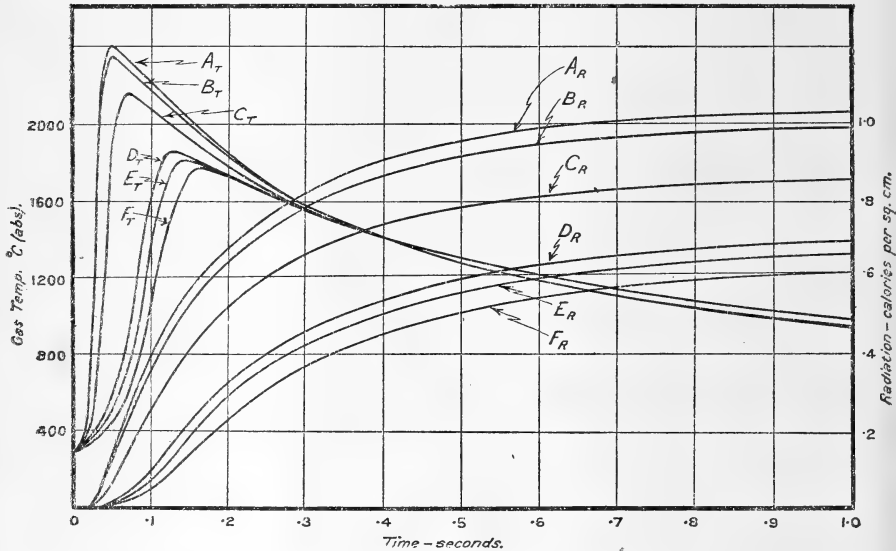

- A curves : 15 % mixture of coal-gas and air.
 B curves : 15 % mixture " " (taken at a later date when
 the cal. value of the coal-gas had probably altered).
 C curves : 13 % mixture of coal-gas and air.
 D curves : 10.2 % mixture " "
 E curves : 10.0 % mixture " "
 F curves : 9.8 % mixture " "

position the radiation measured was very approximately 5 per cent. greater than the mean of that measured in positions A, B, & C. The curves cover a period of one second after ignition, after which time the radiation from the gaseous mixture is very small.

22. A glance at these curves shows at once that a close relationship exists between the total radiation emitted and the maximum gas temperatures developed in the various mixtures, and in fig. 6 the total radiation received by the walls per sq. cm.* has been plotted against the maximum gas temperatures. It will be noted that the total radiation is a linear function of the maximum temperature. The equation to this line is

$$R_T = 0.00056(\theta_{\max.} - 700). \dots \dots (11)$$

(b) *Variation of Total Radiation with Density and Cylinder Dimensions.*

23. The writer does not possess sufficient records to enable him to plot similar curves to that in fig. 6 for other densities.

Fig. 6.

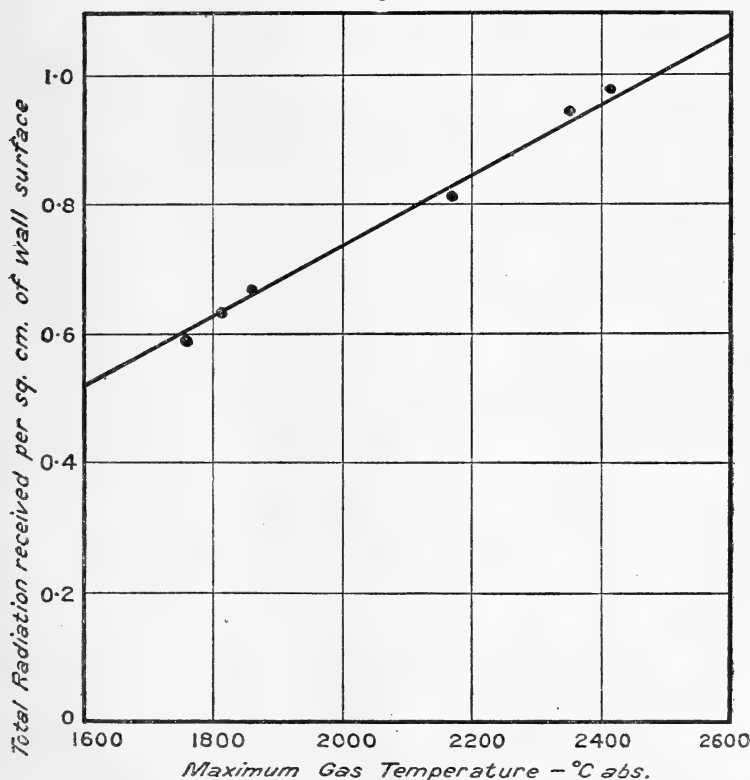

* The radiation values in fig. 6 are those shown in fig. 5 multiplied by 0.95 so as to give the mean values over the whole vessel.

He has, however, two pairs of records for various mixture strengths*, the one pair at $1\frac{1}{4}$ atmospheres density and the other pair at $1\frac{1}{2}$ atmospheres density. Calculations from these records give the information shown in Table III.

TABLE III.

D (atmospheres).	Percent. strength of mixture.	$\theta_{\max.}$	R_T .
1.24	10.2	1800	0.7
1.24	12.2	2250	0.94
1.50	15.0	2400	1.17
1.56	10.0	1840	0.87

The equation derived from the first pair at $1\frac{1}{4}$ atmospheres density is

$$R_T = 0.00053(\theta_{\max.} - 480), \dots (12)$$

and that from the second pair at $1\frac{1}{2}$ atmospheres density (approximately) is

$$R_T = 0.00053(\theta_{\max.} - 190). \dots (13)$$

24. In considering these equations it must be remembered that each is derived from two points only and the constants are therefore not to be relied upon. They show fairly definitely, however, that the greater the density the smaller the constant within the brackets, and it would appear that this constant is dependent upon the shape of the cooling curve.

25. An examination of the records for 15 per cent. mixtures shows that between the limits of density $\frac{3}{4}$ atmosphere and $1\frac{1}{2}$ atmospheres R_T and R_{iT} vary approximately as \sqrt{D} . An approximate relationship between R_T , θ , and D is therefore given by

$$R_T = 0.00056(\theta_{\max.} - 700) \sqrt{D}. \dots (14) \dagger$$

* Taken in position A.

† The form of equations (12) and (13) indicates that it would have been better to express equation (14) in the form $R_T = 0.00055[\theta_{\max.} - 700f(D)]$ where $f(D) = \frac{480}{700}$ when $D = 1.24$ or $\frac{190}{700}$ when $D = 1.53$. But as has been stated equations (12) and (.3) have been derived from two pairs of

26. These records also show that R_{iT} varies with cylinder dimensions in a similar way to that of \dot{R}_i (see § 13). For purposes of rough calculation we may therefore write

$$\begin{aligned} R_{iT} &= 0.00056(\theta_{\max} - 700) \sqrt{D} \sqrt{\frac{l}{30}} \\ &= 0.0001(\theta_{\max} - 700) \sqrt{D \times l} \dots \dots (15) \end{aligned}$$

SUMMARY.

27. An attempt has been made in this paper to build up formulæ by means of which the emission of radiation during explosion and subsequent cooling of inflammable mixtures of coal-gas and air of various strengths in a cylindrical vessel whose diameter is equal to its length and whose walls are black may be estimated from the pressure time-curves for these mixtures. An attempt has also been made to introduce factors into these formulæ so that the radiation may be estimated roughly when the density is other than atmospheric, and also when the explosive gaseous mixture is contained in a cylindrical vessel of dimensions different from those of the experimental vessel.

The conditions governing the emission of radiation in gaseous explosions are exceedingly complex and the formulæ set up can only be relied upon to give results correct to within from 10 to 20 per cent. Nevertheless as no such formulæ have hitherto been set up their formulation it is considered will serve a useful purpose in that they may be used as a basis for gas-engine calculations.

points only, and consequently the figures 480 and 190 may not be sufficiently reliable to enable one to evaluate $f(D)$ with any degree of accuracy. In view of the fact that equation (14) gives results which are fairly well in accord with values for R_T found by experiment within the limits of density $\frac{3}{4}$ atmosphere and $1\frac{1}{2}$ atmospheres, it has been thought worth while to include it in this paper.

VII. *An Analysis of the Radiation emitted in Gaseous Explosions.* By Major W. T. DAVID, M.A.*

1. **I**N this paper the results of some experiments are given on an analysis of the radiation emitted during explosion and subsequent cooling of mixtures of coal-gas and air and of hydrogen and air. These experiments are, it is thought, of considerable interest in that some fairly definite conclusions may be drawn from them as to the origin of the radiation emitted.

2. The radiation from the exploded mixtures was measured † after passing through clear plates of fluorite, quartz, and plate glass. The fluorite plate transmits almost exactly 95 per cent. of the radiation emitted by the exploded mixtures. The quartz plate transmits about 70 per cent. of the radiation of wave-length between about 2μ and 3.5μ ; it is opaque to radiation of longer wave-length, but it is more transparent to radiation of shorter wave-length. The plate glass transmits some 60 to 70 per cent. of the radiation transmitted by the plate of quartz.

3. It is probable that the emission spectrum of an exploded mixture of coal-gas and air is similar in form to that of a Bunsen flame, the important part ‡ of which consists of two clearly defined bands whose maxima are at approximately 2.8μ and 4.4μ §. The fluorite plate transmits both the 2.8μ and the 4.4μ bands. The quartz and plate glass transmit very little of the 4.4μ band, and the radiation measured through them is mainly that of the 2.8μ band.

4. The emission spectrum of a hydrogen flame consists mainly of the 2.8μ band. The experiments on the hydrogen and air mixtures indicate, however, that some radiation of

* Communicated by the Author.

† For full details of the experimental methods employed see Phil. Trans. A. vol. cxxi. p. 375. The measurements recorded in the present paper were all made when the bolometer was placed in position A.

‡ That is, the part containing the bulk of the energy.

§ The 4.4μ band is due entirely to CO_2 and the 2.8μ band is due partly to CO_2 and partly to water vapour. There is also an emission band at about 15μ due to CO_2 , but the energy in the radiation in this band is small in comparison with that in the 2.8μ and 4.4μ bands at the high temperatures developed in these explosions.

longer wave-length than 2.8μ is emitted by these mixtures, which becomes of importance in comparison with the 2.8μ radiation after the temperatures of the mixtures have fallen to about $1400^\circ \text{C. abs.}^*$

Radiation from Coal-gas and Air Mixtures.

5. The results of experiments on a 13 per cent. mixture of coal-gas and air are shown in fig. 1. Curve A_T is the mean gas temperature curve for the mixture after explosion as

Fig. 1.

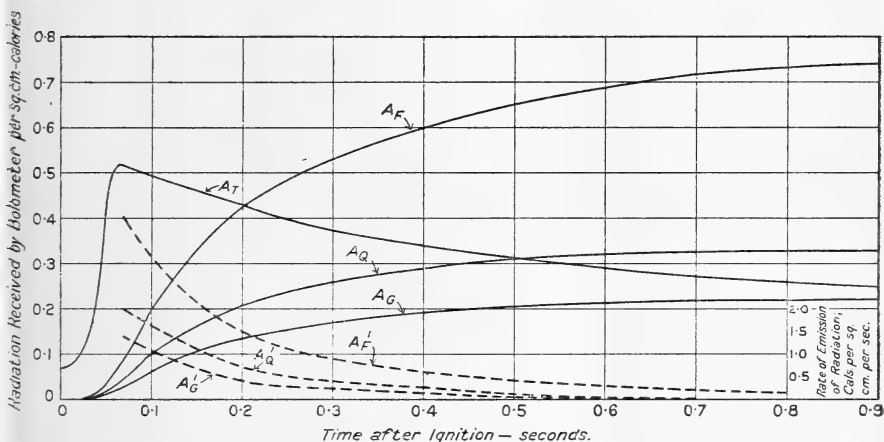

deduced from the pressure curve, and curves $A_F \dagger$, A_Q , and A_G show the radiation measured by a bolometer per sq. cm. of its surface when protected by plates of fluorite, quartz, and plate glass respectively. Curves A_F' , A_Q' ,

* The absorption spectrum of water vapour shows a strong band extending from about 4μ to about 8μ . There is also a series of small bands between 8μ and 20μ , after which it appears to become quite opaque. (See Coblenz, 'Supplementary Investigations of Infra-red Spectra,' Appendix, pp. 148-9.)

† In the case of the fluorite curves an allowance of 5 per cent. has been made for the absorption of the fluorite. No allowance has been made in the case of the quartz and glass curves for the absorption of these substances. No allowance either has been made in the case of any of these curves for a 5 per cent. reflexion which takes place at the blackened surface of the bolometer.

and Ag' are the differentials of the radiation curves and give the rate of emission after passing through these substances. The figures in Table II. have been compiled from these curves. Tables I. and III. give similar information for 15 per cent. and 10 per cent. mixtures respectively*.

TABLE I.

Rate at which Radiation is received from 15 per cent. mixtures of Coal-gas and Air per sq. cm. per sec. through plates of Fluorite, Quartz, and Glass.

Time from ignition. (secs.)	Mean gas temp. (° C. abs.)	Fluorite.	Quartz.	Glass.	Quartz Fluorite	Glass Quartz
0.05	2360 (max. temp.)	5.2	2.75	1.65	0.53	0.61
0.08	2200	4.05	2.15	1.35	0.53	0.63
0.14	2000	2.75	1.45	0.95	0.53	0.65
0.20	1800	1.8	0.9	0.55	0.50	0.61
0.27	1600	1.1	0.5	0.3	0.46	0.60
0.40	1400	0.65	0.3	0.2	0.44	0.67
0.57	1200	0.35	0.1	nearly zero	0.29	—
0.85	1000	0.25	nearly zero	nearly zero	nearly zero	—

* Some of the radiation curves recorded through these diathermanous substances for 15 per cent. mixtures up to 0.5 sec. after ignition have been previously published in Phil. Trans. A. vol. cxxi. p. 389. In the text of that paper (p. 390) it was stated that the proportion of the total radiation emitted registered through quartz to that registered through fluorite was the same whether the bolometer was in position A, B, or C; and further, that it was the same for different mixture strengths. When this statement was written the writer had examined the records for 15 per cent. and 13 per cent. mixtures only, which gave results pretty much alike, viz. 0.495 and 0.477 respectively at the end of half a second after ignition. An examination of the records for a 10 per cent. mixture shows clearly, however, that this proportion diminishes with mixture strength. For this mixture the proportion is 0.413 at half a second after ignition.

All the experiments described in this paper were made with a cast-iron cylindrical explosion vessel whose interior surface was coated with a layer of dull black paint and whose dimensions were 30 cm. in diameter and 30 cm. in length.

TABLE II.

Rate at which Radiation is received from 13 per cent. mixtures of Coal-gas and Air per sq. cm. per sec. through plates of Fluorite, Quartz, and Glass.

Time from ignition, (secs.)	Mean gas temp. ($^{\circ}$ C. abs.)	Fluorite.	Quartz.	Glass.	$\frac{\text{Quartz}}{\text{Fluorite}}$	$\frac{\text{Glass}}{\text{Quartz}}$
0.07	2090 (max. temp.)	4.05	2.05	1.35	0.51	0.66
0.09	2000	3.3	1.70	1.1	0.51	0.63
0.17	1800	2.0	1.0	0.65	0.50	0.65
0.24	1600	1.15	0.55	0.35	0.48	0.64
0.33	1400	0.65	0.3	0.2	0.46	0.67
0.55	1200	0.37	0.1	nearly zero	0.27	—
0.85	1000	0.25	nearly zero	nearly zero	nearly zero	—

TABLE III.

Rate at which Radiation is received from 10 per cent. mixtures of Coal-gas and Air per sq. cm. per sec. through plates of Fluorite, Quartz, and Glass.

Time from ignition, (secs.)	Mean gas temp. ($^{\circ}$ C. abs.)	Fluorite.	Quartz.	Glass.	$\frac{\text{Quartz}}{\text{Fluorite}}$	$\frac{\text{Glass}}{\text{Quartz}}$
0.15	1600	1.85	0.85	0.55	0.46	0.65
0.18	1710 (max. temp.)	1.7	0.75	0.45	0.44	0.60
0.23	1600	1.25	0.5	0.3	0.40	0.60
0.4	1400	0.7	0.25	0.15	0.36	0.60
0.57	1200	0.4	0.1	nearly zero	0.25	—
0.86	1000	0.3	nearly zero	nearly zero	nearly zero	—

6. It will be noticed that the ratio of the emission through glass to that through quartz is pretty much the same for all temperatures and for all mixtures*. This is

* It should be noted that the proportion of CO_2 to water vapour in the exploded mixtures is the same for all mixture strengths. The 15 per cent. mixture after explosion consists of 8.5 per cent. of CO_2 , 20 per cent. of water vapour, and the remainder almost entirely nitrogen and a little excess oxygen.

of course to be expected, for the quartz and glass plates are transparent over more or less the same region of the infra-red spectrum.

7. A glance at these tables will show that the ratio of the emission through quartz to that through fluorite is largely dependent upon the temperature of the gaseous mixtures, and in Table IV. these ratios have been collected

TABLE IV.

Ratio of the Rate at which Radiation is received through Quartz to that through Fluorite for mixtures of Coal-gas and Air of various strengths.

Mean gas temp. (° C. abs.)	15 % mixture.	13 % mixture.	10 % mixture.
2000	0.53	0.51	—
1800	0.50	0.50	—
1600	0.46	0.48	0.40
1400	0.44	0.46	0.36
1200	0.29	0.27	0.25
1000	0.0	0.0	0.0

for various temperatures. They show that the ratio of the energy in the 2.8μ band to the total energy (which, as has been indicated, is mainly concentrated in the two bands whose maxima are at 2.8μ and 4.4μ) decreases as the temperature decreases. They show, further, that the 2.8μ band is rapidly disappearing in the neighbourhood of 1200° C. abs., and when the gas temperature has fallen to 1000° C. abs. it has almost entirely disappeared*.

Radiation from Hydrogen and Air Mixtures.

8. Similar experiments to those described above were made on 25.4 per cent. mixtures of hydrogen and air †.

* It is worthy of remark that the temperature (roughly 1000° C. abs.) at which the 2.8μ radiation ceases to be emitted is roughly that at which the energy in the 2.8μ radiation from a black body is a maximum in the energy spectrum curve corresponding to this temperature.

It may be noted that after the gas temperature has fallen to about 1200° C. the radiation curves recorded through quartz and glass (fig. 1) become very nearly flat, while that recorded through fluorite goes on increasing (slightly) even after the temperature has fallen to below 900° C. abs.

† The 25.4 per cent. mixture of hydrogen after explosion consists of 29 per cent. of water vapour and the remainder almost entirely nitrogen and a little excess oxygen.

The results of these are shown in Table V. It will be noted that these results are similar to those obtained from the coal-gas and air experiments. The ratio of the emission

TABLE V.

Rate at which Radiation is received from 25.4 per cent. mixtures of Hydrogen and Air per sq. cm. per sec. through plates of Fluorite and Quartz.

Time from ignition. (secs.)	Mean gas temp. (° C. abs.) (max. temp.)	Fluorite.	Quartz.	$\frac{\text{Quartz}}{\text{Fluorite}}$
0.017	2400	4.7	3.65	0.79
0.045	2200	3.5	2.6	0.74
0.07	2000	2.45	1.65	0.67
0.12	1800	1.7	1.0	0.59
0.175	1600	1.1	0.6	0.55
0.25	1400	0.7	0.3	0.43
0.38	1200	0.35	0.1	0.29
0.60	1000	0.15	nearly zero	nearly zero

through quartz to that through fluorite decreases as the temperature decreases, and the 2.8μ band disappears at the same temperature as was found for the $\text{CO}_2 \cdot \text{H}_2\text{O}$ mixtures. Above this temperature the ratio is higher than was found in the case of the latter mixtures. This is accounted for by the fact that the hydrogen mixture has no strong 4.4μ band. There must, however, be some radiation from this mixture of greater wave-length than 2.8μ , for except in the neighbourhood of the maximum temperature developed (2400° to 2000° C. abs.) the radiation transmitted through the fluorite is greater than that through the quartz even after making an allowance of 30 per cent. for the absorption of the quartz plate*.

9. In the neighbourhood of the maximum temperature (2400° to 2000° C. abs.) the ratio of the emission through quartz to that through fluorite is a little greater than 0.7.

* See footnote, p. 85. The absorption spectrum of water vapour indicates that this long wave-length radiation is probably due to water vapour. It is conceivable, however, that it may be due to the nitrogen or the excess oxygen. The absorption spectrum of the latter gas shows shallow bands whose maxima are at 3.2μ and 4.7μ .

After making an allowance of 30 per cent. for the absorption of the quartz, the radiation registered through quartz would appear to be greater than that registered through fluorite. It is unlikely that this result is due to experimental error, for in the neighbourhood of the maximum temperature the radiation measurements were made with a high degree of accuracy. A probable explanation is that there is in this epoch considerable energy in radiation of shorter wave-length than 2.8μ for which the absorption of the quartz plate is much less than 30 per cent.*

10. No measurements through quartz are available for hydrogen and air mixtures of other strengths; but some records of measurements of radiation through fluorite for weaker mixtures are of interest, in that the maximum gas temperatures developed approach that at which it has been found that the 2.8μ radiation disappears. The results of these experiments are shown in Table VI.† The 25.4 per

TABLE VI.

Total Radiation emitted in Explosions of Hydrogen and Air mixtures of various strengths.

Percentage strength of mixture.	Heat of combustion of hydrogen present in explosion vessel. (calories.)	Max. press. developed. (lbs. per sq. in. abs.)	Max. temp. developed. ($^{\circ}$ C. abs.)	Total radiation emitted during explosion and subsequent cooling. (calories per sq. cm. of wall surface.)	Total radiation emitted expressed as percentage of heat of combustion of hydrogen.
25.4	16,320	106	2400	0.60	16.1
15.0	9,650	70	1500	0.22	10.0
10.0	6,430	59	1230	0.12	8.2

* The energy in the luminous radiation from a coal-gas and air mixture developing a maximum temperature of the same order is small (see Phil. Trans. A. vol. ccxi. p. 389), though in the hydrogen and air mixture it may be appreciably greater, for the combustion in this mixture is much more violent. Perhaps, too, internal vibrations of the nitrogen molecules corresponding to radiation of wave-length in the neighbourhood of 1μ are excited. Nitrogen in a vacuum tube gives a strong emission band whose maximum is at 1μ approximately (see Coblentz, 'Investigations of Infra-red Spectra,' p. 317).

† The figures for the 10 per cent. mixture have been calculated from a record giving the emission from a cone of small solid angle of the gaseous mixture which is proportional to the total radiation measured

cent. mixture, which develops a maximum temperature of 2400° C. abs., loses by radiation 16.1 per cent. of its heat of combustion; the 15 per cent. mixture, which develops a maximum temperature of 1500° C. abs., loses 10 per cent.; and the 10 per cent. mixture, with a maximum temperature of 1230° C. abs., loses 8.2 per cent.

11. The loss of heat by radiation expressed as a percentage of the heat of combustion in coal-gas and air mixtures within the limits of mixture strength 9.8 per cent. to 15 per cent. does not vary nearly so much*. A 15 per cent. mixture developing a maximum temperature of 2410° C. abs. loses by radiation 26.1 per cent. of its heat of combustion; a 13 per cent. mixture with a maximum temperature of 2170° C. abs. loses 25 per cent.; and a 9.8 per cent. mixture with a maximum temperature of 1700° C. abs. loses 23.6 per cent.

12. The explanation of this is pretty clear in the light of the experiments on the analysis of radiation emitted in the hydrogen and the coal-gas mixtures. The exploded weak hydrogen mixtures spend only a comparatively short period of their history at temperatures at which they emit the 2.8μ band (in which is concentrated the bulk of the radiation energy in hydrogen mixtures). The coal-gas and air mixtures, on the other hand (even the weakest mixture experimented on), spend a great deal of their history at radiating temperatures, both on account of their much slower cooling and also because they emit the strong 4.4μ band which has considerable energy at temperatures at which the 2.8μ band ceases to be emitted.

when the bolometer is placed close up to the plate of fluorite (as was the case in the other measurements). The figures may not compare as regards accuracy with the figures for the other mixture strengths, both for this reason and also because one record only is available for this mixture strength. They are, however, substantially correct; the radiation figure of 0.12 agrees fairly closely with that calculated on the assumption that the linear law connecting total radiation emitted with maximum temperature developed holds for hydrogen and air mixtures in the experimental vessel (see page 81, *suprà*). The equation calculated from the figures measured for the 25.4 per cent. and the 15 per cent. mixtures is $R_T = 0.00042(\theta_{\max.} - 950)$, which gives for the 10 per cent. mixture a value for $R_T = 0.11$.

* Phil. Trans. A. vol. cxxi. pp. 384-5.

Theoretical Discussion.

13. *Radiation due to temperature.*—These experiments offer strong support to the view that the large amount of radiation emitted during the cooling of gaseous mixtures of coal-gas and air and of hydrogen and air after explosion is mainly of thermal origin. The dependence of the ratio of the energy in the 2.8μ radiation to that in the 4.4μ radiation upon temperature, the disappearance of the 2.8μ radiation in the neighbourhood of 1000° C. abs., and the small emission in weak hydrogen mixtures in which the maximum temperatures developed do not greatly exceed this figure, all tend to this conclusion.

14. Theoretical considerations lead to the belief that the rate of partitioning of energy between the vibratory and the translational and rotational degrees of freedom of the molecules of a gas is dependent upon the relation between the vibration periods and the duration of collisions between pairs of molecules. When the duration of collisions is long in comparison with the vibration-period of any particular vibratory degree of freedom (in other words, when the collisions are *soft* in respect to this type of vibration) the rate of partitioning between it and the other degrees of freedom is slow; but when it is short (that is, when the collisions are *hard* in respect to this particular type of vibration) the rate of partitioning may be very rapid.

15. Confine the attention for the moment to one of the types of vibration possessed by CO_2 molecules—say that corresponding to radiation of wave-length 4.4μ . According to the Kinetic Theory the molecules of a gas at any given temperature are moving with widely different velocities grouped about the mean according to the law of errors, and, since the duration of collisions between pairs of molecules depends upon the velocity of approach, a proportion of the collisions at any moment will be soft as regards this type of vibration, while the remainder will be hard. These proportions will clearly vary with temperature. The higher the temperature the larger the proportion of hard collisions, and therefore the quicker the transfer of energy to or from this type of vibration.

16. As regards the other types of vibration possessed by CO_2 molecules (viz. those corresponding to radiation

of wave-length 2.8μ and 15μ *), it will be clear from these considerations that at any given temperature the rate of partitioning will be slower the shorter the vibration period. At any given temperature, therefore, the transfer to or from the degrees of freedom corresponding to 2.8μ radiation will be slower than that from the degrees of freedom corresponding to 4.4μ and 15μ radiation—unless the temperature is so high that the rate is very rapid for all types.

17. Such a theory as that sketched in the preceding sections affords a clear explanation of the reason for the disappearance of the 2.8μ radiation. At $1000^\circ \text{C. abs.}$ it may be supposed that the overwhelming proportion of the molecular collisions are too soft to excite the type of vibration corresponding to this radiation, while they are sufficiently hard to excite the 4.4μ vibrations. As the temperature increases, an increasing proportion of the collisions becomes sufficiently hard to excite the 2.8μ vibrations, and at $1200^\circ \text{C. abs.}$ the volume of 2.8μ radiation emitted (though still a small proportion of the total radiation emitted) indicates that an appreciable proportion of the collisions have become sufficiently hard to enable a transfer from the translational and rotational degrees to go on fairly rapidly so as to balance the loss by radiation. After this temperature the ratio of the energy in the 2.8μ radiation to that in the 4.4μ radiation indicates that the proportion of collisions which are hard in respect to the 2.8μ type of vibration increases very rapidly as the temperature increases.

18. *Radiation due to chemical causes.*—Assuming that much of the energy of chemical combination passes in the first instance into the form of intra-molecular energy †, there appears to be strong evidence in these experiments that the distribution of energy from this cause over the various vibratory degrees of freedom possessed by the molecules is very much dependent upon the degree of violence with which chemical combination takes place. Were the distribution of energy over the vibratory degrees of freedom independent of the violence of combustion, it would have been expected that the ratio of the 2.8μ radiation

* The types of vibration corresponding to luminous radiation are not dealt with in this paper. The molecular collisions, even at the highest temperatures developed in explosions, are too soft to excite these high-frequency vibrations.

† This includes both the rotational and the vibratory energy. There is much experimental foundation for this hypothesis in respect to the vibratory energy (see *Phil. Mag.* Feb. 1913, p. 263).

to the 4.4μ radiation would be greater in the weak mixtures during explosion and in the neighbourhood of the maximum temperature than in the strong mixtures, for the rate of transfer of energy from the 2.8μ type of vibrations relatively to that from the 4.4μ type is slower at the weak mixture temperatures (particularly during the explosion period) than at the strong mixture temperatures. A comparison of the ratios in column 6 of Table III. with those of column 6 of Tables I. and II. shows, however, that this ratio is less in the weak mixture (even during the explosion period, when the temperatures are much lower) than in the strong mixtures. Again, in the weakest hydrogen mixture in which the maximum mean temperature developed is only 1230° C. abs.—at which temperature partitioning is slow—the radiation emitted is small, indicating that the energy given to its vibratory degrees of freedom is small*.

Summary of Results and Conclusions.

19. *Experimental Results.*

(i.) In explosions of coal-gas and air and of hydrogen and air the ratio of the energy in the 2.8μ radiation emitted to that in the radiation of longer wave-length decreases as the temperature decreases.

(ii.) In the neighbourhood of 1200° C. abs. the emission of radiation of wave-length 2.8μ decreases very rapidly with the temperature, and at 1000° C. abs. it is negligible.

(iii.) Radiation of longer wave-length than 2.8μ continues to be emitted even after the temperature has fallen to 900° C. abs., though at this temperature the emission is small.

(iv.) The ratio of the energy in the 2.8μ radiation to that in the 4.4μ radiation in coal-gas and air mixture appears to depend to some extent upon mixture strength as well as upon temperature.

* It should be pointed out that although strong hydrogen mixtures undergo very violent combustion (the 25.4 per cent. mixture had an explosive period of only 0.017 sec.) the weaker mixtures undergo comparatively gentle combustion. The 15 per cent. mixture in the experimental vessel had an explosive period of 0.065 sec. and the 10 per cent. mixture an explosive period of 0.23 sec.

The emission of radiation in the 10 per cent. mixture during the explosion period is so small that it is doubtful whether the 2.8μ vibrations are excited to any appreciable extent. The bulk of the radiation is emitted during the subsequent cooling of the mixture, when the temperatures are of course below 1230° C. abs. It is thought distinctly probable that the radiation emitted is mainly of longer wave-length, but as no record through quartz is available this cannot be confirmed.

(v.) The proportion of the heat of combustion of hydrogen and air mixtures between the limits of mixture strength 10 per cent. to 25.4 per cent. decreases very rapidly as the mixture strength decreases. The variation in this proportion in coal-gas and air mixtures between the limits of mixture strength 9.8 per cent. to 15 per cent. is small.

20. *Theoretical Conclusions.*

(vi.) The radiation emitted during the cooling of coal-gas and air mixtures and of hydrogen and air mixtures after explosion is largely due to thermal causes.

(vii.) The transfer of energy between the vibratory degrees of freedom corresponding to radiation of wave-length 2.8μ and the other degrees of freedom of the molecules is comparatively slow at 1200° C. abs. and practically ceases at 1000° C. abs. Transfer of energy to or from the vibratory degrees of freedom corresponding to longer wave-length goes on at least until the mean temperature of the gas falls to 900° C. abs.

(viii.) The energy acquired on combustion by the various vibratory degrees of freedom of the freshly formed CO_2 and H_2O molecules depends upon the degree of violence with which the combustion proceeds. The greater the violence of combustion the greater the ratio of the energy in those degrees of freedom corresponding to radiation of wave-length 2.8μ to that in the degrees of freedom corresponding to radiation of greater wave-length.

It is thought that there are grounds for promoting this into a general law which may be briefly stated thus:—The intra-molecular energy acquired on combustion by the freshly formed molecules of CO_2 and H_2O is not equally partitioned over the various internal degrees of freedom possessed by these molecules. When the combustion is gentle the intra-molecular energy is concentrated in the rotational degrees of freedom, and in such very low frequency vibrations as the molecules may be capable of executing. As the combustion becomes more violent the higher frequency vibrations share in this energy, and it is possible that during combustion of extreme violence equi-partitioning of energy amongst all the internal degrees of freedom of the molecules may be approached momentarily.

Such a theory as this would serve to explain many of the phenomena of the explosion period—including the pre-pressure period during which a considerable volume of inflammation takes place. This will be attempted in another paper.

VIII. *A Method and Instrument for the Measurement of the Visibility of Objects.* By LOYD A. JONES*.

Introduction.

DURING the summer of 1917 when the ravages of the submarine began to be a serious menace to marine shipping, various schemes of painting were devised, designed to protect the surface craft from attack by the submarine. The object of these earlier systems of painting was to render the vessel thus painted as invisible as possible and thus to elude observation by the submarine operator. Extravagant and conflicting claims were made as to the efficiency of the various methods and no satisfactory means of deciding upon their relative merits appeared to exist. It was at this time that Mr. Lindon W. Bates, Chairman of the Engineering Committee of the Submarine Defence Association, requested us to take up the problem of finding some precise means of measuring the visibility of ships painted according to various of these low visibility schemes and further to devise, if possible, a system of painting giving the lowest possible visibility. Some means of precise measurement was highly desirable in order that the claims of the various systems might be correctly evaluated by a method not involving a personal judgment.

When the work on this subject was taken up a survey of the field showed that at that time no method for the numerical specification of visibility, or instrument for its quantitative measurement, was available. The first step, therefore, was the working out, from the theoretical standpoint, of the fundamental laws upon which the quantitative evaluation of visibility could be based. Following this an instrument, operating upon the proper principle as indicated by the theoretical equations and suitable either for the measurement of visibility values of small models under known conditions of illumination and background or of actual boats at sea, was designed and built.

The method and instrument proved to be entirely satisfactory and some very interesting practical results were obtained in the examination of various so-called low visibility systems of painting. However, it is not the intention of this paper to deal with practical results but rather to confine ourselves to a treatment of those phases of the problem

* Communication No. 79 from the Research Laboratory of the Eastman Kodak Company. Communicated by the Director.

of greatest interest from a purely scientific point of view, namely, the theoretical analysis of the visibility problem, the measurement and numerical specification of visibility, and the instrument designed for this purpose.

Nomenclature and Definitions.

The intensity factor of the sensation resulting from the incidence of radiant energy upon the retina is expressed in terms of brightness. The brightness, B , of an element of luminous surface from any point of view may be expressed in terms of the luminous intensity per unit area of that surface projected on a plane perpendicular to the line of sight. When expressed in this manner it is measured in candles per unit area of the projected area. Brightness may also be expressed, and perhaps more logically, in terms of the specific luminous radiation of an ideal perfectly diffusing surface, that is a surface obeying Lambert's law. The brightness unit in this case is the lambert, which is defined as equal to the brightness of an ideal surface radiating or reflecting one lumen per square centimetre. In practice this unit is too large for convenience and hence the millilambert or $\cdot 001$ lambert is used. An ideal, perfectly diffusing surface emitting one lumen per square foot will have a brightness of $1\cdot 076$ millilamberts. Measurements of brightness are made by means of a suitable form of photometer calibrated to read directly in the desired brightness units. The brightness of a surface depends upon two factors, the illumination of that surface and its reflecting power.

The illumination, E , of a surface at any point is the luminous flux density incident on the surface at that point, or the flux per unit of intercepting area. "Luminous Flux," F , is the rate of flow of radiant energy evaluated with reference to the visual sensation, and is expressed in lumens: the lumen being defined as equal to the flux emitted in a unit solid angle (steradian) by a point source of unit candle-power. The c.g.s. unit of illumination is the phot, which is defined as one lumen per square centimetre. The practical unit in most common use, however, is the foot candle, which is defined as one lumen per square foot, and which is equal to $1\cdot 0764$ milliphots. For a uniformly illuminated surface,

$$E = \frac{F}{S}, \quad S \text{ being the area.}$$

Illumination is measured by a special type of photometer,
Phil. Mag. S. 6. Vol. 39. No. 229. Jan. 1920. H

usually referred to as a lumeter or illumometer, these being calibrated to read directly in some suitable illumination units.

The coefficient of reflexion or total reflecting power of a surface is defined as the ratio of the total reflected luminous flux to the total incident luminous flux. In most practical work this value is not of great importance, the value desired being that of the reflecting power of the surface measured under certain specified conditions, such as the angle of incidence of the flux and the position from which the surface is viewed. The term "Reflexion Factor," R , is used to indicate this particular value and is defined as the ratio of the reflected to the incident flux. Reflexion from a surface may be either specular, diffuse, or a mixture of the two. In the case of pure specular reflexion all of the incident flux is reflected in such a way that the angle of reflexion is equal to the angle of incidence; while in the case of completely diffuse reflexion the reflected flux is equal in all directions regardless of the angle of incidence, the distribution being in accord with Lambert's cosine law. Very few cases of pure specular or diffuse reflexion are found in practice, there being generally a superposition of the two. The reflexion factor is measured by the use of a reflectometer, a photometer of special design, care being taken that conditions of illumination and angle of view are such as to give correct values for application in the particular case under consideration. This value is purely numeric and is usually expressed as a percentage value. If, with a specified condition of illumination, the reflexion factor, R , and the brightness, B , of a surface are measured from the same position, then $B = E \cdot R$, and hence the value of E may be determined; or in any case where two of these factors are known the third can be computed.

The quality factor of the luminous flux is that property which depends upon the spectral distribution of that flux, colour being defined as the subjective evaluation as expressed in terms of hue and purity or saturation. Hue is that property of colour which depends upon the variation in the sensation due to the variation of the wave-length of the luminous flux, while saturation expresses the proximity of the colour to a condition of monochromatism. Monochromatic spectral light has a saturation of 100 per cent., while pure white light has a saturation of zero. White, therefore, is a limiting colour having no hue and zero saturation. In practice it has been found convenient in many cases to express the saturation factor in the inverse order, that is as impurity rather than purity. The term used

in such expression is called the "per cent. white," for which the symbol I is used. Thus a colour for which $I=100$ per cent. is equivalent to zero saturation and if $I=0$ per cent., saturation is 100 per cent.

It has been demonstrated experimentally that any colour can be matched by the mixture, in the proper proportions, of white light with monochromatic spectral light of the proper wave-length. In this way a direct measurement of the fundamental sensation properties of a colour may be made. The hue is specified by the wave-length of monochromatic light used (wave-length of the dominant hue). The saturation is specified either as the purity (per cent. hue) or as the impurity (per cent. white), the former value being obtained from the ratio of the intensity of the monochromatic to the total intensity (monochromatic plus white) of the mixture, while the latter value (per cent. white) is given by the ratio of the intensity of the white to the total intensity of the mixture. These values are pure numerics. The usual unit used in expressing the wave-length of light is the millimicron, which is equal to .0000001 centimetre and is designated by the symbol $\mu\mu$.

In the foregoing paragraphs have been defined the various terms that will be used in the following discussion of the subject of visibility. These are summarized briefly in the following table for convenience of reference :—

<i>Symbol.</i>	<i>Quantity.</i>	<i>Unit.</i>
F	Luminous Flux.	Lumen.
E	Illumination.	Foot Candle.
B	Brightness.	Lambert.
R	Reflexion Factor.	Per cent.
H	Hue.	Wave-length ($\mu\mu$).
S	Saturation	
	Purity.	Per cent. Hue.
	Impurity.	Per cent. White.

Theoretical Analysis of the Visibility Problem.

In general it may be said that non-luminous objects are visible by virtue of the light reflected from them. However, any particular object in the field of vision becomes visible as such only by contrast with its surroundings—that is, when the light emanating from that object (either by reflexion or emission) differs in some respect from the light

flux which enters the eye from the projected space immediately surrounding that object. The sensation caused by the incidence of radiant energy, which we call light, upon the retina of the eye may be said to consist of two factors, brightness and colour, the former being dependent upon the intensity and the latter upon the quality of the incident radiation. This second factor of the sensation may be said also to consist of two parts, hue and purity or saturation. Hue refers to the position, in the spectrum, of the dominant wave-length, and saturation expresses the proximity of the colour to monochromatism. It is evident, therefore, that a sensation due to the impingement of radiant energy upon the retina may vary in three respects, that is, with respect to brightness, hue, and saturation. A contrast in the visual field resulting in the visibility of an object may be due, therefore, to brightness contrast, to hue contrast, or to saturation contrast; or to a combination of any two or all three of these factors.

For the purposes of the theoretical treatment of this problem it will be necessary to make certain simplifying hypotheses. Begin first with the problem of the determination of the visibility of an object uniform in colour and brightness viewed against a background also of uniform

Fig. 1.

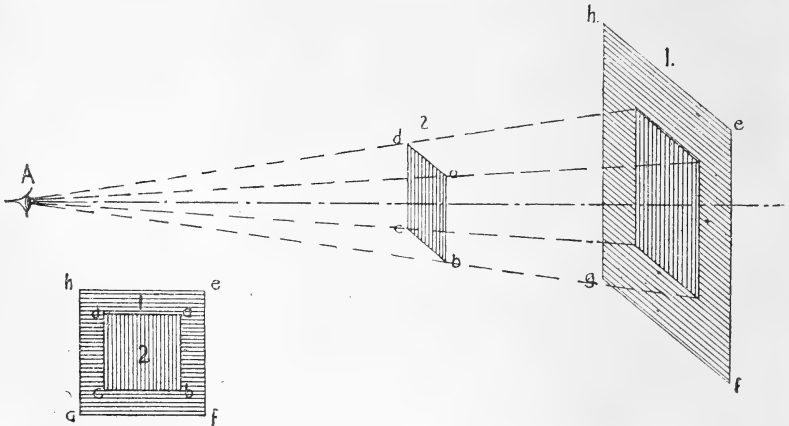

Diagrammatic Illustration of the Relation of Object to Background.

colour and brightness. In fig. 1 this case is shown in perspective, 1 being the background, 2 the object, and A the eye or view-point. The visual field will appear as shown in

the lower left-hand drawing of fig. 1, 2 representing the object (rectangle *abcd*) and, 1, the background (rectangle *efgh*).

The terms used in the discussion and the symbols employed are as indicated previously except that a subscript number or letter attached to a given symbol indicates that the term applies to the object or surface designated by that number or letter. Thus E_1 is the symbol used for the illumination on the surface 1, the background.

Assume for the moment that the object and background are illuminated by light of the same quality and also that this quality be specified as white, which is defined as light from the noon sun on a clear day or its spectral equivalent. Now, the visibility, V , of the object as seen against this background is dependent upon the total contrast existing between the two. This total contrast is made up of three factors: (1) Brightness contrast, C_b ; (2) Hue contrast, C_h ; and (3) Saturation contrast, C_s . These three factors of the total contrast may be evaluated as follows:—

$$C_b = f(B_1, B_2),$$

$$C_h = f(H_1, H_2),$$

$$C_s = f(S_1, S_2).$$

The total visibility may then be expressed in the general form,

$$V = f(C_b, C_h, C_s).$$

The laws governing the reaction of the retina to the various brightness stimuli are so well established that it is comparatively easy to evaluate the term $C_b = f(B_1, B_2)$ directly in terms of visibility, to make quantitative measurements of visibility as such, and to correlate such determination made under widely different conditions. Unfortunately, the other terms, C_h and C_s , cannot be so readily evaluated. This is due to the lack of knowledge concerning the fundamental reactions of the retina to these stimuli. However, it is possible by a direct method of measurement to determine the total visibility of an object against a given background. Such a value includes in a single term the visibility due to all three kinds of contrast. Since the part of total visibility due to brightness contrast may be determined independently, a means is thus available of evaluating that part of visibility due to the combined effect of hue and saturation contrast. Since hue and saturation are the two factors of quality, the part of total visibility due to hue and saturation may for convenience be designated

as quality contrast, C_q . It should be borne in mind, however, that this term includes two independent variables, both of which must be considered in any evaluation of visibility due to quality contrast. It is entirely possible that the visibility due to C_b and C_s could be evaluated separately, but this would require a large amount of fundamental research which it will not be advisable or necessary to go into at this time.

The visibility resulting from brightness contrast is directly proportional to the subjective contrast and hence for an eye adapted to a fixed brightness level to the ratio of the two brightnesses, B_1 and B_2 . Therefore, we may write

$$V_b = f\left(\frac{B_1}{B_2}\right).$$

A direct measurement of B_1 and B_2 will therefore determine V_b . This method is satisfactory and applicable if there is no hue or saturation contrast between object and background, and if the object and background are each uniform in brightness, hue, and saturation. These conditions, however, do not exist in practice. Brightness measurements in the presence of colour differences are difficult to make and subject to great errors. Moreover, in practice it is frequently necessary to determine visibility in cases where the object or background is not uniform in brightness, the variation being irregular and practically indeterminate. In such cases the determination of the effective values of B_1 and B_2 is extremely difficult and, if not impossible, entirely impracticable. These objections to this method of measuring visibility are so serious as to make it almost useless from the practical standpoint, and hence it is necessary to consider other methods for the accomplishment of the desired result.

A careful consideration of the causes of lowered visibility reveals the fact that loss of visibility results from the introduction of veiling glare between the eye and the object and also to a lowering in the brightness of the object and its background. In order to explain the action of this veiling glare in producing a diminution or in some cases an entire loss of visibility, it will be helpful to present a curve, fig. 2, which shows in graphic form the contrast sensibility of the eye*. The abscissæ values of this curve are the field or background brightness, the ordinates are the ratio of ΔB to B_1 . The term ΔB , the least perceptible difference, is the brightness difference between B_1 and B_2 when that difference

* P. G. Nutting, Trans. Ill. Eng. Soc. vol. xi. p. 945 (1916).

is just perceptible to the eye when adapted to the field brightness B_1 . The sensibility is inversely proportional to ΔB and hence to

$$\frac{\Delta B}{B_1}.$$

Fig. 2.

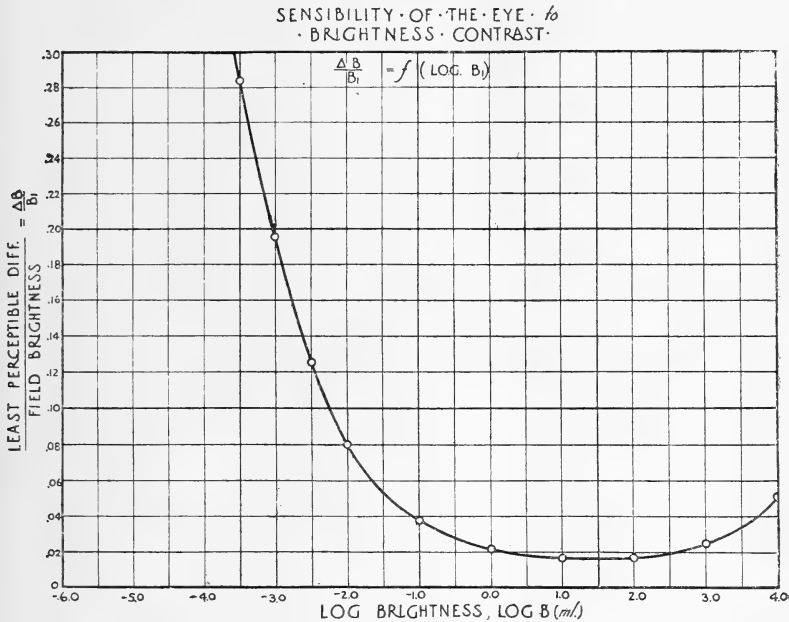

The Sensibility of the Eye to Brightness Contrast.

The curve shown is therefore the reciprocal of the sensibility curve and is given in this form for the sake of convenience in application to this problem. It will be noted that the sensibility at low values of B is relatively low (ΔB large) increasing to a maximum (ΔB small), which remains sensibly constant over a considerable range of brightness values and then again decreasing for very high values of B_1 .

The term k , which will be called the "contrast constant" of the eye for any given value of B , is defined by the equation,

$$k = 1 + \frac{\Delta B}{B_1}.$$

Since $\Delta B = B_1 - B_2$ or $B_2 - B_1$, depending upon the absolute magnitude of the values, it follows that

$$k = \frac{B_1}{B_2} \text{ or } \frac{B_2}{B_1},$$

that ratio being used which results in a value of k greater than unity.

It is evident that if
$$\frac{B_1}{B_2} = k,$$

the object, 2, of fig. 1 will be just visible against the background, 1;

while if
$$\frac{B_1}{B_2} < k,$$

the object will be invisible.

Now, in case
$$\frac{B_1}{B_2} > k,$$

if it is possible by any means to reduce the value of the ratio to the point where

$$\frac{B_1}{B_2}$$

is just less than k , the object will be rendered just invisible. This can be accomplished by adding the same brightness, B_v , to both B_1 and B_2 . B_v being of the magnitude required to satisfy the equation

$$\frac{B_1 + B_v}{B_2 + B_v} = k.$$

This superposed brightness, B_v , will be referred to as "veiling glare."

Now, the magnitude of B_v required to satisfy the equation just given may be taken as a direct measure of the visibility of objects under constant conditions of illumination. It is evident, however, that the value of B_v required by the equation will depend not only upon the ratio of B_1 to B_2 , but also upon the absolute values of those terms. Now, assuming that k is constant, and not dependent upon B_1 , visibility must be independent of the absolute value of either B_1 or B_2 , and a function only of their ratio. Such evaluation may be accomplished by writing,

$$V_b = \frac{B_v}{B_1}.$$

In order to determine visibility, therefore, it is only

necessary to measure the values B_1 and B_v in any particular case. In practice the veiling glare, B_v , is produced artificially by inserting at some convenient point between the eye and the object a semi-transparent surface of some sort, such as a half-silvered mirror, this surface being illuminated to the desired brightness, B_v , by any convenient method. The values of B_1 and B_v may be measured by means of a suitable brightness photometer. The visibility of any object, under a fixed set of conditions, may now be specified in definite units directly comparable with the visibility of different objects under the same conditions.

It is evident that a variation in value of any one of the four terms, E_1 , E_2 , R_1 , and R_2 , will cause a corresponding change in the value of V_b . Visibility may be evaluated, therefore, as a function of any one of these four terms as a variable and the remaining three as constants, thus ;

$$\begin{aligned} V_b &= f(R_1) && R_2, E_1, \text{ and } E_2 \text{ constants,} \\ V_b &= f(R_2) && R_1, E_1, \text{ and } E_2 \text{ constants,} \\ V_b &= f(E_1) && E_2, R_1, \text{ and } R_2 \text{ constants,} \\ V_b &= f(E_2) && E_1, R_1, \text{ and } R_2 \text{ constants.} \end{aligned}$$

It is entirely possible to evaluate each of these functions, but a consideration of the problem to which the theory is later to be applied shows that this is not necessary and that a different method of evaluation is more directly applicable.

In the problems to which the results of this theoretical treatment are to be applied the sky forms the background in most of the cases to be considered, and it is impossible in general to treat the sky as a surface. It is not possible, nor is it necessary, to determine independently the values of the reflexion factor and illumination in dealing with this sky background. However, its brightness can easily be measured and from the standpoint of brightness the sky may therefore be regarded and treated as a surface. The variables E_1 and R_1 are therefore eliminated from this problem, being replaced by a single term, B_1 . This leaves for consideration the three variables, E_2 , R_2 , and B_1 , for each of which as a variable an evaluation of V_b may be formulated. Again, considering conditions in nature, it will be seen that E_2 and B_1 are not in general independent variables but more or less dependent one upon the other. It is desirable, therefore, to combine these two into a single term, as a function of which visibility may be expressed. This combination of B_1 and E_2 is best accomplished by taking the ratio of the former to the latter. This ratio is a complete specification of the lighting conditions

at any instant and is therefore in the practical problem of an object illuminated by natural light a complete specification of the weather conditions at a given time. This term will be referred to as the "Weather Coefficient," W , its evaluation in terms of the other quantities being expressed by the equation

$$W = \frac{B_1}{E_2}.$$

The variables to be considered are therefore R_2 and W , and the necessary evaluations of visibility are of the form, $V_b = f(R_2)$, $W = a$ constant; and $V_b = f(W)$, $R_2 = a$ constant. The first equation when properly formulated will make possible the computation of the variation in visibility due to a variation in the value of the reflexion factor, for any specified value of the weather coefficient; the second equation will give the variation in visibility with the value of the weather coefficient for any object of definite reflexion power.

Before proceeding with the formulation of these visibility functions it is desirable, for the sake of clearness, to summarize briefly the terms thus far defined which must be used in the subsequent development of the theory.

B_1 = Brightness of background.

B_2 = Brightness of object.

E_2 = Illumination of object.

R_2 = Reflexion factor of object.

B_v = Brightness of veiling glare which when superposed over object and background will reduce the contrast to a just imperceptible value.

V_b = Brightness visibility.

W = Weather Coefficient.

k = Constant contrast of the eye.

Now, B_v must satisfy the equation,

$$\frac{B_1 + B_v}{B_2 + B_v} = c, \quad \dots \dots \dots (1)$$

where c is a constant depending upon whether B_1 is greater or less than B_2 .

If $\frac{B_1}{B_2} > k, c = k; \dots \dots \dots (2)$

or if $\frac{B_1}{B_2} < k, c = \frac{1}{k}, \dots \dots \dots (3)$

solving equation (1), for B_v we obtain,

$$B_v = \frac{B_1 - c B_2}{c - 1} \dots \dots \dots (4)$$

Now, $B_2 = E_2 \cdot R_2 \dots \dots \dots (5)$

$$\therefore B_v = \frac{B_1 - c E_2 R_2}{c - 1} \dots \dots \dots (6)$$

Also, $V_b = \frac{B_v}{B_1} \dots \dots \dots (7)$

Therefore, $V_b = \frac{B_1 - c E_2 R_2}{B_1(c - 1)}$
 $= \frac{1}{c - 1} - \left(\frac{E_2}{B_1} \cdot R_2 \frac{c}{c - 1} \right) \dots \dots (8)$

As previously shown,

$$W = \frac{B_1}{E_2} \dots \dots \dots (9)$$

therefore $V_b = \frac{1}{c - 1} - \left(\frac{1}{W} R_2 \cdot \frac{c}{c - 1} \right),$

$$V_b = \left(\frac{1}{W} \cdot R_2 \cdot \frac{c}{1 - c} \right) - \frac{1}{1 - c} \dots \dots (10)$$

Equation (10) is a general expression of brightness visibility as a function of both W and R_2 .

Now, in evaluating the constant c it is found that there are two possible values, one in case $\frac{B_1}{B_2} > k$, and one for the case where $\frac{B_1}{B_2} < k$.

Case I., $\frac{B_1}{B_2} > k, c = k,$

$$V_b = \left(\frac{1}{W} \cdot R_2 \cdot \frac{k}{1 - k} \right) - \frac{1}{1 - k} \dots \dots (11)$$

Case II., $\frac{B_1}{B_2} < k, c = \frac{1}{k},$

$$V_b = \left(\frac{1}{W} \cdot R_2 \frac{1}{k - 1} \right) - \frac{k}{k - 1} \dots \dots (12)$$

Equations (11) and (12) now express visibility as a function

of the variables R_2 and W for the two cases covering all values of the ratio

$$\frac{B_1}{B_2}$$

If in these equations R_2 be treated as a constant they then express visibility in the form $V_b = f(W)$; while if W be treated as a constant they express visibility in the form $V_b = f(R_2)$.

Now the value of the contrast constant k can be determined from the sensibility curve, fig. 2, for any specified value of B_1 . Let a value of $k = 1.02$ be assumed and then by assuming a series of values for R_2 a family of curves showing V as a function of W can be plotted. These curves are given in fig. 3, the ordinate values being visibility, V_b ,

Fig. 3.

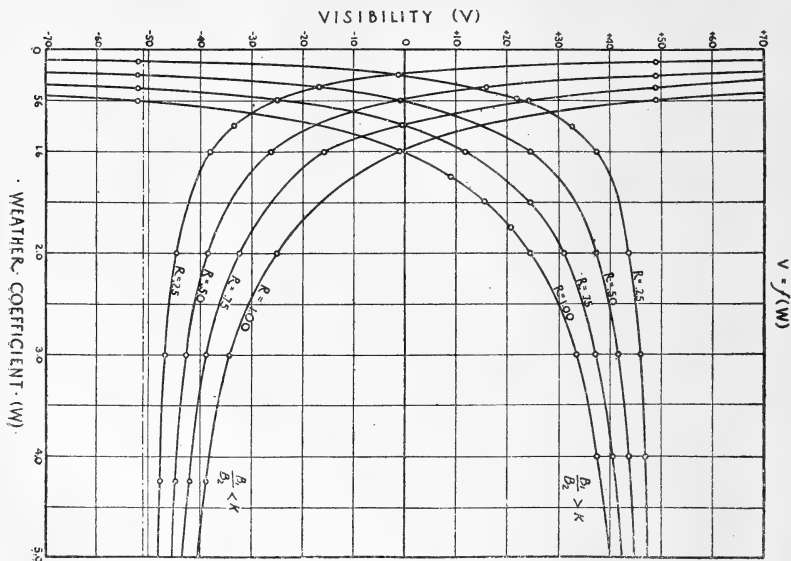

Visibility as a Function of the Weather Coefficient.

and the abscissæ values the weather coefficient, W . It will be seen from fig. 3 that

Case I.,
$$\frac{B_1}{B_2} > k,$$

is represented by a group of rectangular hyperbolæ having

as asymptotes the lines $y = +50$ and $x = 0$; while

$$\text{Case II., } \frac{B_1}{B_2} < k,$$

gives a family of hyperbolæ having as asymptotes the lines $y = -51$ and $x = 0$.

It will be seen that considerable portions of these curves lie in the fourth quadrant where values of V_b are negative. It is obviously impossible to have values of visibility less than zero, hence all such values may be considered as unreal or imaginary. The only portions of the curves of interest in this problem are those lying in the first quadrant. It will be noted also that in general visibility is high for very low values of W , decreasing to zero at a value of W which depends upon the assumed value of R_2 , and then rising (approaching $V = +50$ as a limit) for high values of W . It will be noted that for any given value of R_2 there is a small range of W values for which $W = 0$. If we express this range by the symbol ΔW its value may be expressed by the equation,

$$\Delta W = R_2 \frac{k-1}{k}.$$

Thus the range of weather conditions for which V can be zero is a function of both R_2 and k . It will be seen by examination of the curves that $V = 0$ when $R_2 = W$. An object becomes invisible against a given background when the reflexion factor, R_2 , of that object is equal to the ratio of background brightness, B_1 , to the illumination, E_2 , on the object plane, that is when $B_1 = B_2$.

Now, passing on to a consideration of visibility as a function of the reflexion factor, R_2 , as a variable quantity and W as constant, the curves shown in fig. 4 are obtained by solution of equations (11) and (12) for various fixed values of W and the same value of k ($k = 1.02$) as was used previously. It will be seen that

$$\text{Case I., } \frac{B_1}{B_2} > k,$$

is represented by a series of straight lines, all passing through the point $x = 0, y = +50$. The slope of the line for any particular assumed value of W is given by the expression

$$\tan \alpha = \frac{k}{W(1-k)}.$$

Case II., $\frac{B_1}{B_2} < k,$

leads to family of straight lines all passing through the point $x=0, y=-51$, the slope of any one being given by the equation

$$\tan a = \frac{1}{W(k-1)}.$$

Fig. 4.

$$V = f(R_2)$$

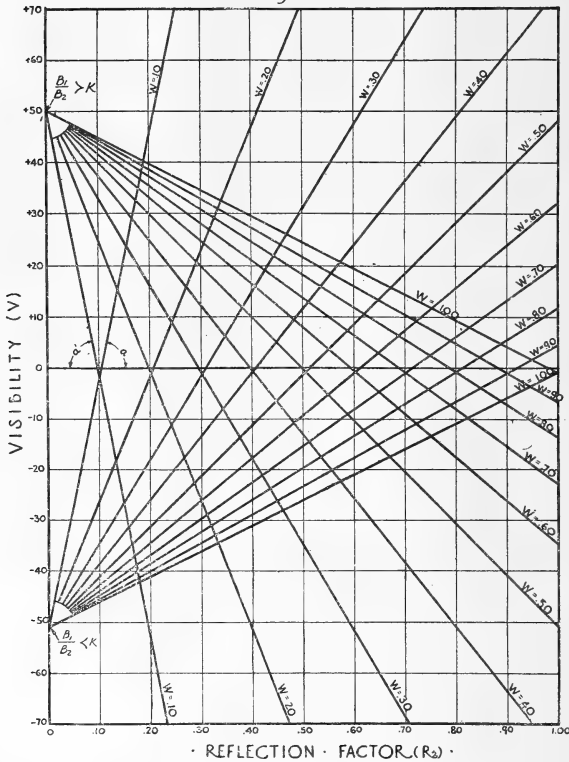

Visibility as a Function of the Reflexion Factor.

It will be noticed in solving for the value of $\tan a$ that in

Case I., where $\frac{B_1}{B_2} > k,$

the value is negative, while the value of $\tan a$ in Case II. is positive. This offers a convenient method for indicating

whether the object to which any visibility value applies is lighter or darker than the background against which it is measured. The visibility value itself must from the very nature of the term be always positive, but by specifying the sign of the first derivative of the visibility function at a given point it can be determined whether such visibility is due to the object being brighter than the background or *vice versa*. The first derivative of the function

$$V = f(R_2) \text{ is } \frac{dV}{dR_2},$$

which, since the function is a straight line, is equal to the tangent, thus

$$\frac{dV}{dR_2} = \tan \alpha.$$

If $\frac{dV}{dR_2}$ is negative it indicates that $\frac{B_1}{B_2} > k$

and therefore that the object is darker than the background.

In case $\frac{dV}{dR_2}$ is positive it indicates that $\frac{B_1}{B_2} < k$

and therefore that the object is brighter than the background.

In the data presented later in the paper the visibility values will be followed by plus or minus signs, which will be understood to indicate the sign of the first derivative of the function at that point and hence show the relative magnitude of B_1 and B_2 . A convenient way of remembering the significance of these signs will be to consider that the plus sign indicates that the addition of brightness to the background is needed in order to make it match the object, while the minus sign indicates that brightness must be subtracted from the background. In case a visibility value is represented by a point lying upon the branch of negative slope and also upon the branch of positive slope, that is, at the point of intersection of the two lines forming a complete curve of V for all values of R_2 , $\frac{dV}{dR}$ for that visibility value is either negative or positive. In such a case $B_1 = B_2$, and if the visibility value is greater than zero such visibility must be ascribed to either hue or saturation contrast or to the combined effect of these factors. In order to designate such conditions, the visibility value will be followed by the sign plus or minus, \pm .

As in the previous set of curves, those of fig. 3, only the values of V lying in the first quadrant are real. The curves of fig. 4 show in graphic form the variation of visibility with

the reflexion factor of the object for a fixed value of the weather coefficient. It will be again noted that $V_b=0$ when $R_2=W$.

This completes the theoretical treatment of visibility due to brightness contrast. In closing the discussion it may be well to review briefly the most important points. Visibility due to brightness contrast, V_b , is measured by a determination of B_v , the veiling glare which when superposed upon the object and background will reduce the contrast to a just perceptible value. The fundamental equation is

$$\frac{B_1 + B_v}{B_2 + B_v} = c,$$

where c is a constant depending for its value upon the sensibility functions of the eye. Formulations of the functions $V_b=f(R_2)$ and $V_b=f(W)$ lead to equations (11) and (12), by solution of which curves given in figs. 3 and 4 are obtained. It is also shown that for $V_b=0$, $R_2=W$. As stated previously, the term V_q is composed of two factors, V_h , hue visibility, and V_s , saturation visibility. Notwithstanding the fact that the sensibility of the eye to hue and purity differences is fairly well known, it is not possible to formulate directly the visibility functions in these cases. It may be said in general that $V_h=f(H_1, H_2)$, but just what form the function will take it is impossible to say. It is probable that the maximum visibility will be found when H_1 and H_2 are complementary hues, diminishing to a zero value as H_1-H_2 approaches zero. It is equally impossible in the light of our present knowledge to evaluate the expression $V_s=f(S_1, S_2)$. However, it is evident that V_s can be zero only when $S_1=S_2$, that is, when the saturation of the object is equal to the saturation of the background. It will probably be found that V_s is directly proportional to the saturation difference, in which case the expression would be of the form, $V_s=a(S_1-S_2)$, where a is a constant of proportionality which may or may not vary for different values of H . At present it is sufficient to give the general form of the evaluation of V_q , which includes V_h and V_s . The total visibility, V , can be measured by the superposition of a veiling glare, B_v ; and by measuring B_1 and B_2 , V_b can be computed by means of the theoretical equations. In this way V_b and V_q may be separated if desired. It is evident that the expression for V (total visibility) must be of the form

$$V=f(V_b, V_h, V_s).$$

Since none of the terms V_b , V_h , and V_s can ever be less than zero, it is evident that in order to obtain a value of $V=0$, V_b , V_h , and V_s must each be equal to zero. That is, no object can be invisible against a given background unless it matches that background in brightness, hue, and saturation, these conditions being expressed symbolically by the equations $B_1=B_2$, $H_1=H_2$, and $S_1=S_2$.

Natural Causes of Lowered Visibility.

In considering the visibility of objects at relatively great distances from the observer, situated in natural surroundings and subjected to lighting conditions which depend upon the state of the weather, it becomes necessary to introduce some new factors into the problem. Thus far we have dealt with the brightness of a surface and have assumed that if measured in a given direction the value will be independent of the distance between the surface and the point of observation. This is true in case there is no absorption or emission of light within the space between the surface and the point of observation. In general, this condition cannot be assumed to exist in nature, for the air through which an object is viewed may carry in suspension particles of matter in a more or less finely divided state which may absorb or scatter the light reflected or emitted by the objects viewed, thus causing the apparent brightness from a given point of observation to be less than the real brightness determined at the surface. Such particles, if illuminated either by light reflected or emitted by the objects viewed or by light from other sources, may, by reflecting, refracting, or diffracting this incident light, cause it to enter the eye of the observer. Such particles act, therefore, as sources of light within the space between the object and the observer, thus causing the apparent brightness of the surface to be greater than its real value. It is necessary to deal, therefore, with objects distributed in three-dimensional spaces which may be filled with minute particles acting as sources or sinks of light causing the apparent brightness of a surface from a given point of observation at some distance from that surface to be different from the real brightness measured from a point near or at that surface. Thus far we have dealt only with the real values of surface brightness of objects distributed in a space free from such sources and sinks of light. In order to treat the more complex problem it is necessary to expand the nomenclature to include the spatial distribution of light as well as of objects.

Let us take a specific case of an object uniform in reflexion factor and colour (hue and saturation), the visible surface of which occupies a position in an approximately vertical plane perpendicular to the line of sight. Let us assume further that this object is viewed against a sky background uniform in brightness and colour. This condition is shown in perspective in fig. 5. The eye or viewpoint is at A,

Fig. 5.

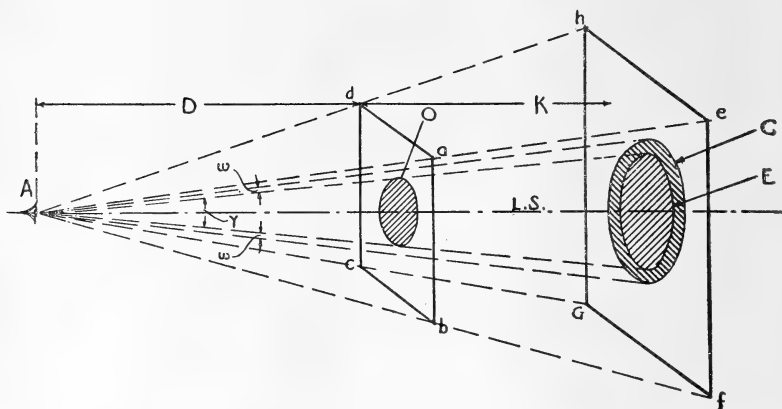

A Diagrammatic Illustration of the Relation of Object to Background.

the line of sight being the line LS. The object, 2, is represented by the circle O lying in the object plane *abcd*, which is approximately perpendicular to the line of sight. The background, 1, is represented by the imaginary plane *efgh*, also perpendicular to LS and situated at infinity. The angle subtended by the object at the eye is γ , and is assumed to be small.

In fig. 6 is shown a cross-section obtained by passing a horizontal plane through the line of sight. The object is at O, the line AB is the trace of the object plane and the line MN is that of the background plane. For the purposes of this discussion we need deal only with that part of the background immediately surrounding the object which is included in the angle ω , that is the space lying within the circle C and outside of circle E, of fig. 5, the projection of the object on the background plane. The visual field in this case is as shown in the lower right-hand drawing of fig. 6, the area marked 2 being the object and that marked 1 the background. It should be understood that the background is not limited as indicated, but that for

the purposes of this discussion only that portion of it which surrounds the object need be considered. It will be convenient for the sake of reference to divide the space into two parts: (a) the space lying between A and the object

Fig. 6.

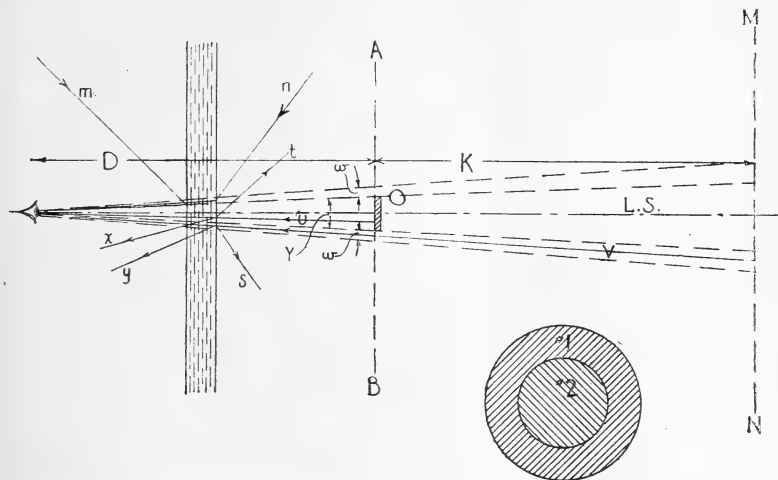

Horizontal Section through the Line of Sight.

plane will be termed the "foreground space," D; (b) the space between the object plane and the background plane will be called the "background space," K.

Material particles in these spaces may react in four ways upon light traversing this space. If very small, such particles will cause diffraction; if larger, reflexion, absorption, and refraction. Thus the intensity of a beam of light travelling in a given direction may be diminished by any one of these four effects, also light may appear to originate in the space between the point of observation and the object viewed from any one of three of these four causes. It is unnecessary for the purposes of this discussion to evaluate the losses or gains in brightness for each of these different causes, it being sufficient to evaluate the total gain or loss under any particular condition. From the standpoint of apparent brightness any diminution in the brightness value may be regarded as due to absorption whether the light is absorbed or scattered by the particles present in the space lying between the point of observation and the surface being considered. Likewise any increase in the apparent brightness may be regarded as a

superposed brightness arising from any or all of the possible causes. The action of a given space containing material particles upon a brightness viewed through that space may effectively be defined by two factors, the transmission, T , and the effective brightness, P . The transmission may be defined as the ratio of the transmitted to the incident intensity, and effective brightness as the apparent brightness of a perfectly black surface when viewed through the space under consideration. Consider the case of a surface of which the real brightness is B viewed through specified space of which the transmission is T , and the effective brightness P . The apparent brightness, L , of that surface will be given by the expression $L = (B \cdot T) + P$.

Turning now to a consideration of conditions existing in nature, if neither the background nor foreground space contained any material particles capable of producing a scattering of light, the sky would be perfectly black and B_1 , the brightness of the background, would be zero, while the apparent brightness of the object would be equal to its real brightness, $L_2 = B_2$. Such conditions, of course, never exist since the air itself and the very small particles of matter always carried in suspension cause scatter by diffraction, thus giving rise to the blue light that we call the sky. Such conditions we term a perfectly clear atmosphere, the sky being a dark blue, practically uniform in colour and brightness from zenith to horizon. There is practically no emission or absorption of light within the foreground space, hence $L_1 = B_1$ and $L_2 = B_2 = E_2 \cdot R_2$.

Consider next the case where the background space, K , contains, in addition to the scattering material always present, larger particles which produce scatter by reflexion or refraction or both; $L_1 = (B_1 \cdot T_k) + P_k$. In most cases the fog or clouds formed by the particles in the space K are so dense that T_k is very small and L_1 is practically $= P_k$. That is, the sky is obscured and the entire brightness is due to light reflected and refracted from the cloud structure within the background space. Since there is no scattering material within the space D , $L_2 = B_2$. Finally, assume that both space D and K are filled with scattering particles, then

$$L_1 = [(B_1 \cdot T_k) + P_k] \cdot T_d + P_d.$$

It is unnecessary in practice to separate the factors of the brightness due to the various causes in the background space, and hence for the sake of simplicity the symbol B_1 (background brightness) is used to include all such factors. The symbol B_1 will therefore be used for the term $(B_1 \cdot T_a + P_k)$.

The special expression for apparent background brightness L_1 therefore becomes $L_1 = (B_1 \cdot T_d) + P_d$.

The expression for visibility due to brightness contrast given in a previous section of this paper was

$$V_b = \frac{B_v}{B_1} \dots \dots \dots (7)$$

B_v being defined by the equation

$$\frac{B_1 + B_v}{B_2 + B_v} = c \dots \dots \dots (1)$$

By superposing the veiling brightness B_v over both B_1 and B_2 , the apparent brightness of each is changed until the ratio of the apparent brightness is equal to the constant c . $B_1 + B_v$, therefore, is the apparent brightness of the background. Hence

$$B_1 + B_v = L_1 = (B_1 \cdot T_d) + P_d,$$

and likewise

$$B_2 + B_v = L_2 = (B_2 \cdot T_d) + P_d.$$

These equations are satisfied if $B_v = P_d$ and $T_d = \text{unity}$. These equations show the exact analogy existing between the conditions assumed in the theoretical evaluation of visibility and those conditions that actually occur in nature resulting in lowered visibility.

It will be well at this point to discuss the direct effect upon visibility of various distributions of the scattering material. Take first the ideal case of no scattering material at any point. The sky will be black, $L_1 = B_1 = 0$. The only case of low visibility would be for a perfectly black object, and as such do not exist, visibility would in general be high. In case of a clear atmosphere visibility is low only in case the object matches the sky (dark blue) in colour and brightness. Since there is no veiling brightness or absorption of light within the foreground space, visibility would in general be high. Consider now the presence of other scattering material, such as clouds, mist, fog, dust, &c., located entirely in the background space, and either localized in a given region or uniformly distributed over a considerable distance in the direction of the line of sight. This will operate to change the apparent brightness and colour of the area 1 of the visual field in the lower right hand drawing of fig. 6, but will not change the value of the brightness or colour of the object, 2. The change produced may be in any direction, depending upon the nature, amount, and spatial distribution of the scattering material. The presence of such material in

this space behind the object plane may either raise or lower the visibility of the object, depending on the precise existing conditions. Hence the presence of such material cannot in general be termed a cause of lowered visibility, although in some cases it may operate in that direction. The brightness B_1 is in this case also a result of the summation of the light entering the eye from any and all points within the angle ω , and from between A and infinity. This light is scattered sunlight, the scattering being due to diffraction, reflexion, and refraction, the last two factors being predominant in the case of cloudy sky or of mist in the atmosphere.

Now let us consider the case where scattering material is found also in the space between the eye, A, and the object plane. This material may be localized in a particular region or uniformly distributed throughout the space from A to the object plane. The presence of this finely divided material, such as dust, mist, &c., will operate in two ways upon the apparent values of the brightness of object and background. A decrease in the intensity of the light emanating from the object and background space will be accompanied by an increase in the intensity of the light apparently emitted by the foreground space. That is, T_d and P_d in general vary according to some inverse law. In order to separate the action of these factors let us take it that $T_d = \text{unity}$ and allow P_d to vary. Some value of P_d is thus added to both B_1 and B_2 , and it will be seen that whatever the value of P_d the ratio of B_1 to B_2 will be decreased, thus causing a lowering of visibility. Assuming a small constant value of P_d , it will be seen that an increase in T_d will change both B_1 and B_2 in the same proportion, thus keeping their ratio constant. A variation in T_d , therefore, affects the visibility only in so far as the change in B_1 governs the value of k (the contrast factor of the eye). Since the highest values of B_1 found in nature are not above the point where

$$\frac{\Delta B}{B_1}$$

begins to increase (due to very high values of B_1), it follows that if a variation in T_d has any effect upon visibility it will be to lower the value of that term.

As stated previously, the relation between the terms T (transmission) and P (effective brightness) is in general expressed by some inverse function. Thus as P increases in magnitude, T usually diminishes. No general expression

for the relation between these two terms can be given without an exact knowledge of the physical characteristics of the scattering and absorbing particles. Thus, in case the particles are opaque and of low reflecting power, the term P may be almost negligible while T is very low, so that the entire effect upon the apparent brightness of an object viewed through the space filled with such particles is due to the absorption of light by the particles, the expression for apparent brightness being $L=B.T$. On the other hand, if the particles are highly reflecting or transparent, the predominant factor may be P (the effective brightness). The relative magnitude of P and T depends to some extent also upon the conditions of illumination prevailing in the space considered. It is not feasible, therefore, to formulate the relation between P and T for all cases since this relation involves a consideration of the nature, size, and spatial distribution of the scattering particles and also the conditions of illumination.

In closing this section of the discussion it will be well to summarize briefly the conclusions reached regarding the visibility of an object under natural atmospheric conditions and let its visibility have an appreciable value which may be termed its initial visibility. A change of this initial value is in general due to the presence in the atmosphere of material particles which may either diffract, absorb, reflect, or refract the light travelling through the space occupied by such particles. If these particles are confined to the background space the change in initial visibility may be either positive, negative, or zero, depending upon the particular conditions. If the particles exist in the foreground space the change in the initial visibility will in general be either zero or negative, although it is possible under certain conditions to produce an increase in visibility by means of absorbing elements in the foreground. This latter case is very unusual. The final conclusion may therefore be drawn that in the great majority of cases low visibility is due to the presence of absorbing or scattering material in the foreground space which operates in such a way as to lower the apparent contrast between the object and its background.

The Measurement and Specification of Visibility.

The general principles upon which the specifications of visibility must be based have been outlined in the section dealing with the theory of the subject. It will be remembered that visibility may be specified in terms of the brightness of a veiling glare, B_v , and the brightness of

the background, B_1 , against which the object is viewed. This veiling glare was defined as that brightness which, when superposed upon the visual field composed of an object and its background, will reduce the apparent contrast between object and background to the limit of visibility. It will be remembered that the discussion referred to dealt with the valuation of the visibility due to brightness contrast, V_b . Now suppose that in addition to a brightness contrast, a contrast in either hue or saturation also exists. The amount of veiling glare required to reduce the total contrast to a just perceptible value will in general be greater than in case the colour contrast was not present. It is entirely logical, therefore, to apply the same general method for the evaluation of total visibility, that is, the superposition over the object and background of a veiling glare of sufficient brightness to reduce the total contrast to zero. The distinction between the terms V_b and V , the total visibility, should, however, be borne in mind. The total visibility in any case, whether that visibility be due either to brightness, hue, or saturation contrast, or to any combination of these terms, is evaluated in terms of the equivalent brightness contrast which would produce the same degree of visibility. The validity of such a method is strongly supported by the fact that loss of visibility in nature is almost entirely due to the presence of a veiling glare which is quite constant in quality, its colour being approximately white, but variable in intensity. This natural veiling glare, arising from the presence of diffusing material in the foreground space, produces a lowering of the visibility value regardless of whether the initial visibility is due to brightness, hue, or saturation contrast.

It was necessary to design and build an instrument and to develop methods for the precise measurement of these qualities, B_b and B_1 , under practical conditions. After extensive preliminary trials a satisfactory instrument was developed. Several different types, all operating upon the same basic principles, having been designed, the type which appeared to be most convenient for practical work was chosen and a complete instrument constructed. This instrument is called a "Visibility-Meter," and patents covering the basic principles upon which it is constructed and several particular designs have been applied for by the Eastman Kodak Company, in whose Research Laboratory these experiments were conducted. In fig. 7 is given a diagrammatic sketch showing the arrangement of the essential parts of the instrument, and figs. 8 and 9 show photographs of the completed instrument.

The letter M, fig. 7, indicates a semi-transparent mirror set at 45° to the axis of the instrument, which is coincident with the axis of sight. This mirror reflects about 50 per cent. of the incident light and transmits approximately 20 per cent., the remaining 20 per cent. being absorbed. The

Fig. 7.

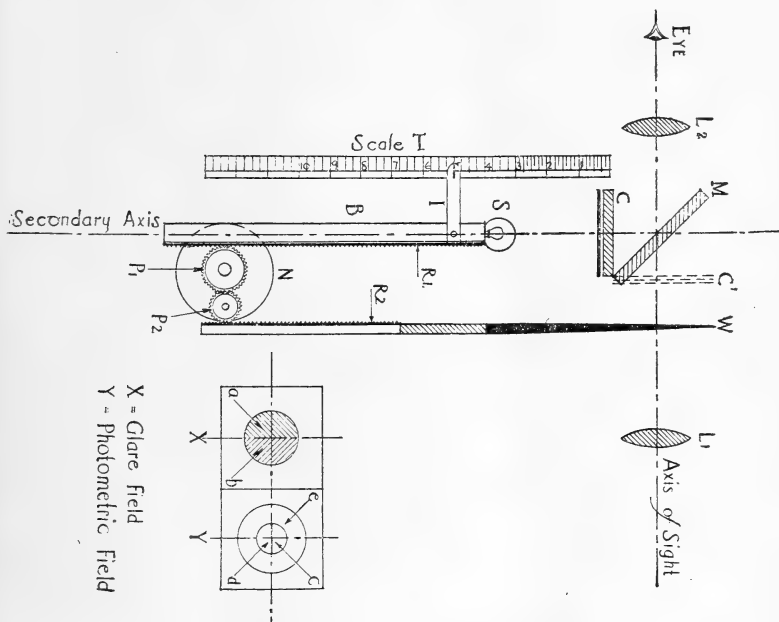

Diagrammatic Illustration of the Visibility Meter.

secondary axis of the instrument is a line perpendicular to the axis of sight at the point where the reflecting surface intersects the axis of sight. C is a diffusing member composed of pot or flashed opal glass placed perpendicular to the secondary axis. This diffusing surface is illuminated by a light source, S, mounted so as to move along the secondary axis. This source is mounted at one end of a brass tube, B, on one side of which is the rack, R₁. A knurled hand wheel, N, is mounted rigidly on a shaft carrying also the pinion P₁, which engages the rack R₁, thus providing for the movement of the source along the secondary axis by a rotation of the hand wheel, N. A second pinion, P₂, in mesh with P₁, engages the rack R₂, which is rigidly attached to the frame carrying the neutral gray non-diffusing optical wedge, W.

This wedge varies continually in opacity from one end to the other, and is so arranged as to move across the axis of sight. The object lens, L_1 , is of such focal length that the object of which the visibility is to be measured is imaged sharply at

Fig. 8.

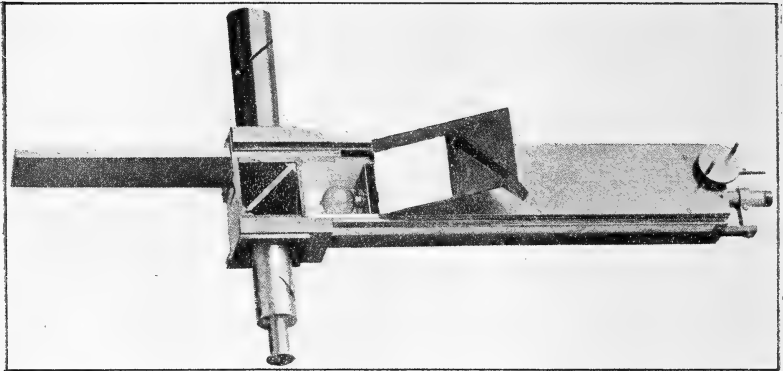

The Visibility Meter Open.

Fig. 9.

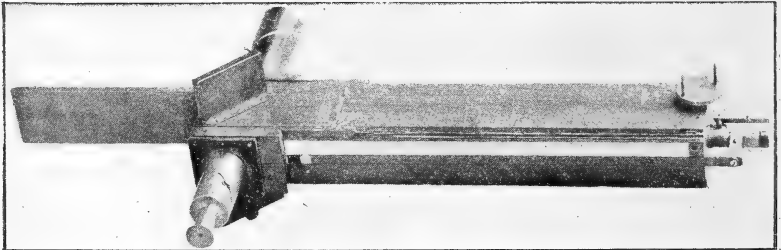

The Visibility-Meter Closed.

the point where the reflecting surface, M , intersects the axis of sight. This lens is adjustable in position, so that either near or far objects may be imaged in the proper plane. The eye lens, L_2 , is of such power that the magnification of the system is unity, thus giving a retinal image of the same size as when the object is viewed with the naked eye. The lens L_2 enables the eye to see clearly defined the image formed by the lens L_1 . The mirror M may be replaced by a simple photometric field for the purpose of measuring brightness, it

being necessary to measure B_1 in order to obtain the visibility value. The details of the interchangeable field are shown in the small right hand drawing of fig. 7.

In order to increase the sensibility of the instrument in the measurement of B_v , a strip of clear gelatine film is placed over one-half of the field, thus increasing the reflecting power of that half by about 8 per cent. If a be the half of the field thus covered, it will for a given position of the source, S , cause a brighter veiling glare to appear as superposed over the object and background than the other half of the field, b . Now, if the object be so adjusted in the field of the instrument that the line between the two halves of the field bisects (approximately) the object, that part of the object in the field b will still be visible when the other part (that in field a) has been completely obscured by the veiling glare of that part of the field. In this way certain limits are set between which every setting must be made. If it is desired to decrease the difference in brightness between the two parts of the field (in order to narrow the limits of the setting), this may be done by making the reflecting powers of one-half of the field any desired amount greater than the other. This is easily accomplished if the reflecting surface is made by depositing the reflecting metal on the glass by a cathodic discharge.

The photometric field is made by covering one-half, c , of the small circular opening with a piece of brightly reflecting matt paper. The white paper is illuminated by the source, S , and the other half, d , being open, permits the eye to see the image of the object or background formed by the lens L_1 . The line between c and d (when the photometric field is in a position for use) lies at the intersection of the axis of sight with the secondary axis and hence is the plane in which the object is imaged by the lens L_1 . The circular field e surrounding the photometric fields, c and d , is made of grey matt paper. This is the type of field actually used in the instrument, but any of the well-known types, such as a Lummer-Brodhun cube, may be substituted if desired, the chief requirement being a sharp dividing line lying in the image plane. These two fields are mounted in a small metal frame sliding in milled metal ways placed perpendicular to the plane through the axis of the instrument. Stops are provided so that each field may easily and quickly be brought into position with the axis of sight passing through the centre of the field being used. A light filter is placed at F . This filter is of such quality that the light from the source S after passing through the filter matches in colour

the light which illuminates the object and background. A graduated scale, T, is fastened rigidly to the case which encloses the source. An index, I, attached to the source or its supporting member moves along this scale indicating at all times the position of the source, S, and wedge, W, with reference to the axis of sight. The scale is so calibrated that from the position of the index at any instant the brightness of the glare field B_1 and the transmission of the wedge (T_a) on the axis of sight can be determined. By turning the hand wheel N the source S and the wedge W are caused to move simultaneously and in such fashion that an increase in the brightness of the veiling glare, B_1 , is accompanied by a decrease in the transmission of the wedge of the axis of sight. This decrease in transmission causes a diminution in the intensity of the light which reaches the eye from the object and background.

Now the light transmitted by the diffusing member C is reflected into the eye, appearing to come from the image of that surface. Thus diffuse white light is caused to enter the eye from a point between the eye and the object being observed, increasing the apparent brightness of both object and background by the same amount and causing the ratio of B_1 to B_2 to be lowered. At the same time the wedge W is introduced causing a proportionate reduction in the apparent brightness of both B_1 and B_2 .

It will be seen, therefore, that the action of the instrument is exactly analogous to the action of material particles distributed through the foreground space, *i. e.*, the production of a veiling glare between the eye and the object and the absorption of a certain percentage of the light reflected or emitted by the object and background. Now, if the source and wedge be moved to such a position that the object is just visible in one part of the field and not visible in the other a setting is obtained from which the values of B_v and T_a can be determined.

In our fundamental equations, B_v was defined as the brightness of the veiling glare which when superposed over object and background will reduce the visibility to zero or a just perceptible value. It will be noted that as no term covering the decrease in brightness due to absorption of light in the foreground space appears in those equations, it is inferred that the entire loss of visibility is produced by the veiling glare, B_v . Now, the effect of the introduction of an absorbing member such as the wedge, W, is merely to decrease the amount of veiling glare required to reduce the visibility to zero. It is not feasible in practice to produce the extinction

of visibility by a veiling glare alone, due to the fact that the values of B_1 and B_2 are so high that a source of very high intensity would be required to give the required value of B_v . As it is desirable to make the instrument as portable as possible such sources cannot conveniently be used on account of the excessive weight of storage batteries required to operate them. By using an absorbing wedge in the axis of sight a much smaller lamp may be used. Such procedure does not in any way interfere with the correct determination of B_v . In order to obtain the maximum possible illumination on the diffusing member with a lamp of given energy consumption, the interior walls of the chamber inclosing the source, S , are painted white. This tends to increase the brightness of the diffusing member and also to increase the uniformity of illumination on this surface, which is extremely desirable. This painting of the interior walls prevents the use of the inverse square law in computing the illumination on the diffusing surface from known values of intensity of source and distance between source and surface. This, however, does not interfere in any way with the operation of the instrument.

For a given ratio of B_1 to B_2 the value of B_v required to produce a loss of visibility is directly proportional to the absolute values of B_1 and B_2 . Thus, by reducing the apparent brightness of B_1 and B_2 to one-tenth of their actual values by means of the member W , only one-tenth of the amount of veiling glare from the surface of M will be required to produce a given lowering of visibility. The brightness of the glare field of the instrument will be designated by B_v' and should not be confused with the term B_v appearing in the equations. The value of B_v is computed from those of B_v' and T_a , the transmission of the wedge W at the point through which passes the axis of sight.

The statement that the value of B_v , appearing in the fundamental equations, is directly proportional to B_1 or B_2 and hence inversely proportional to T_a rests upon a basic assumption which should be mentioned at this point. In order for this to be true, k , the contrast factor of the eye must remain constant. That is, the total field of brightness to which the eye is subjected must not change sufficiently to cause an accompanying change in k . This factor is satisfied in the instrument by so adjusting the density gradient of the wedge W and the linear velocity of the wedge relative to that of the source, that the total field of brightness B_t , of the instrument remains sensibly constant regardless of the

position of the members relative to the axis of sight. It is not possible to obtain exact constancy of B_t for all values of B_1 , but B_t can be kept within the range for which k is constant. However, in case B_t should vary beyond the specified range of values it is still possible to compute B_v , provided the resulting change in the value of k is known. If B_t is measured, which can easily be done, the corresponding values of k may be read from the curve in fig. 2. In practice it is found that B_t can be kept within the required limits in almost all cases by choosing a wedge of proper density gradient and by adjusting the number of teeth on the pinions so that the desired relative motions of S and W are obtained.

The above consideration shows that it is not necessary to exactly simulate in the instrument the relations existing in nature between the values of the veiling glare brightness and the opacity arising from the particles suspended in the foreground space. Since this relation is not constant for all natural conditions, being dependent up the nature, size, and spatial distribution of such scattering and absorbing particles, it would be quite impossible to make a single instrument exactly simulating all possible conditions resulting in lowered visibility.

Now it will be noted by referring to the theoretical treatment that

$$V = \frac{B_v}{B_1}.$$

It is necessary, therefore, to determine the value of B_1 . This is done by substituting for the glare field X, in fig. 7, the photometric field Y. The instrument being calibrated as a brightness photometer, the value of B_1 is read directly from the scale when a photometric balance exists between the fields c and d . The field d is filled by the image of the background.

In order to obtain a value of W , the weather coefficient, which is defined by the expression

$$W = \frac{B_1}{E_2}, \dots \dots \dots (9)$$

it is necessary also to determine the value of E_2 , the illumination on the object plane. This may be done by measurement of the brightness, B_0 , of a surface on the object plane of which the reflexion factor R_0 is known. Such a surface is termed a test plane and is made by covering a frame of the proper size with canvas or sail cloth painted with several coats of a matt white paint. The reflexion factor, R_0 , of this surface is carefully determined by suitable laboratory methods. When determinations of visibility are to be made this test plane is fixed in the object

plane so that its brightness may be read from the designated point of observation.

The procedure in taking a complete visibility reading then consists of three steps:—

(1) With the glare field in position the instrument is so set that the image of the object occupies a position in the field X, fig. 7, such that the dividing line between *a* and *b* approximately bisects the image. The hand wheel N is then turned until the object is just visible in field *b*, and is invisible in field *a*. The position of the index on the scale S is then read giving the scale reading S_1 .

(2) The photometric field is thrown into position and the instrument so aligned that the image of the background fills the portion *d* of the field Y, fig. 7. N is then turned until *d* and *c* are equal in brightness and the position of the index being read gives the scale reading S_2 .

(3) The alignment of the instrument is changed so that the image of the test plane fills the field *d* and a photometric balance is again made by turning N. The position of the index now gives the third scale reading S_3 .

Fig. 10.

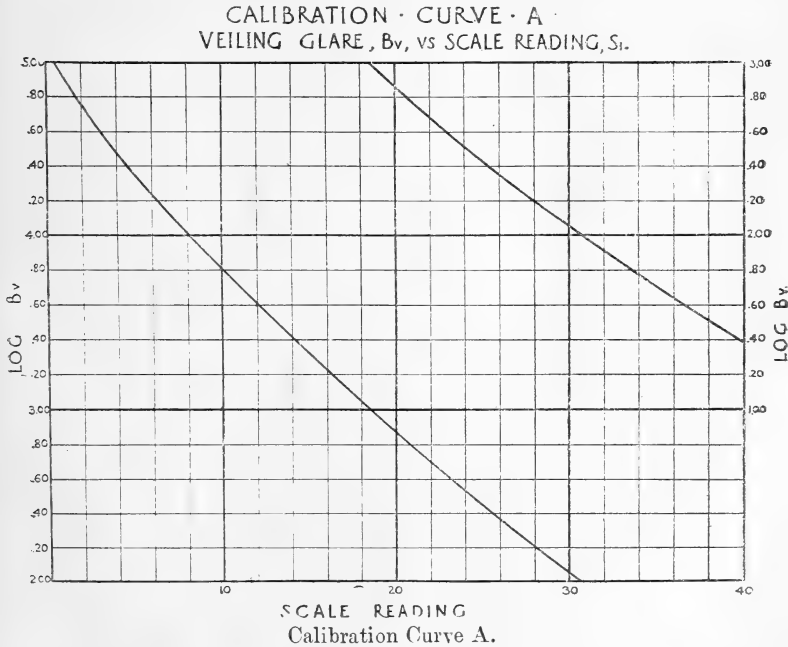

Two calibration curves for the instrument must be prepared, shown in figs. 10, 11, and 12. Curve A is for veiling

Fig. 11.

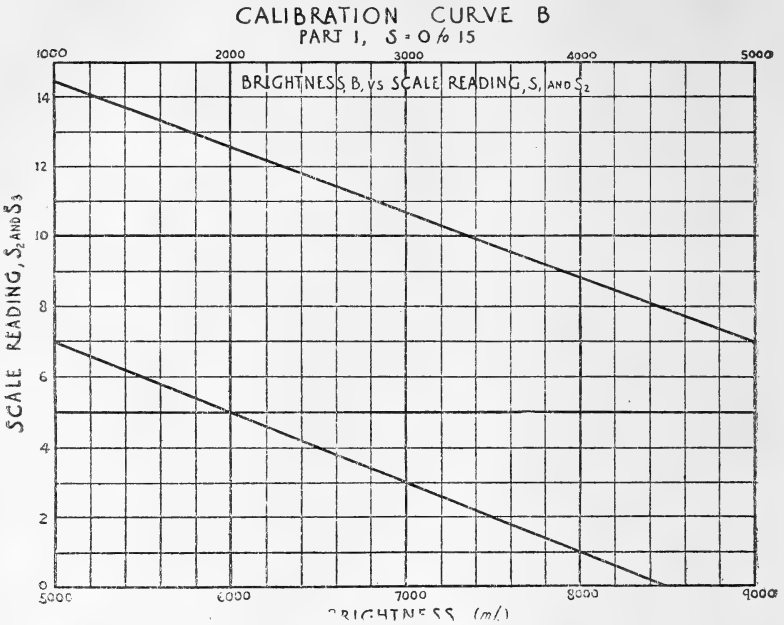

Calibration Curve B, Part I.

Fig. 12.

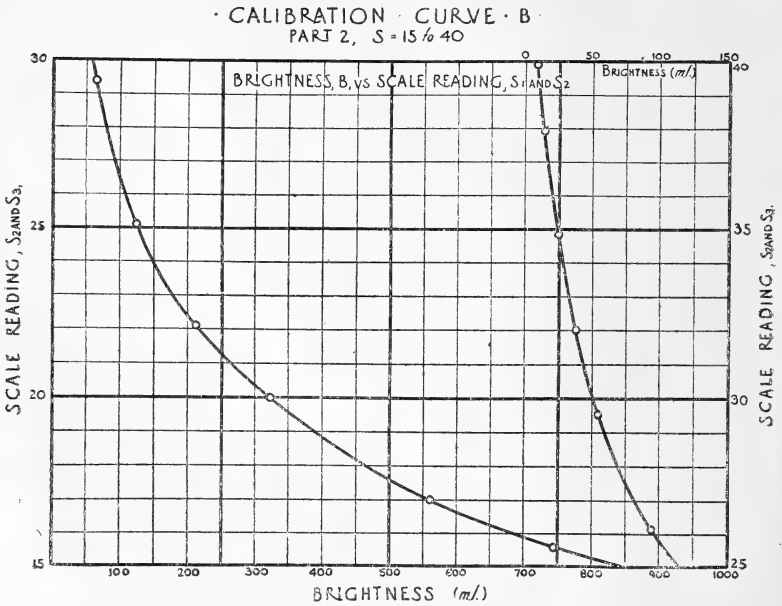

Calibration Curve B, Part II.

glare, the curve having $\log B_v$ values as ordinates and scale readings as abscissæ. Curve B is for brightness. It has scale readings as ordinates and brightness values as abscissæ. By the use of S_1 and Curve A, B_v is obtained, and by using Curve S_2 and Curve B, the value of B_1 is found. S_3 in conjunction with Curve B gives B_0 .

The relations from which the Curves A and B are obtained and the methods of computing the final values of visibility from the observed values are given below. The values read directly are the scale readings :

- S_1 = Visibility setting,
- S_2 = Photometric setting on background,
- S_3 = Photometric setting on test plane.

By the use of the Curves A and B :

- S_1 gives B_v = Brightness of veiling glare,
- S_2 gives B_1 = Brightness of background,
- S_3 gives B_0 = Brightness of test plane.

Other terms, the values of which must be previously determined, are :

- T_a = Transmission of wedge, W,
- T_m = Transmission of mirror, M,
- R_m = Reflexion factor of mirror, M,
- R_0 = Reflexion factor of test plane,
- B_c = Brightness of upper surface of diffusing member, C.

The terms of which the values may be computed from the available data are :

- V = Total visibility,
- W = Weather Coefficient,
- B_f = Total field brightness,
- B_v' = Brightness of glare field instrument.
- E_2 = Illumination on object plane.

Some of the relations existing between the various terms are given below :

$$\begin{aligned}
 B_v &= \frac{B_v'}{T_a \cdot T_m}, \\
 B_v' &= B_c \cdot R_m, \\
 B_v &= \frac{B_c \cdot R_m}{T_a \cdot T_m} \dots \dots \dots (13)
 \end{aligned}$$

T_m and R_m are constants, while B_c and T_a are variable with the value of the scale reading. The relation between the scale reading and B_c and R_m must be determined, after which equation (13) is used for obtaining the values of $\log B_c$, from which in turn the Calibration Curve A is plotted.

$$\begin{aligned}
 V &= \frac{B_1}{B_v}, \\
 W &= \frac{B_1}{E_2}, \\
 E_2 &= \frac{B_0}{R_0} \dots \dots \dots (14) \\
 \therefore W &= \frac{B_1 \cdot R_0}{B_0}.
 \end{aligned}$$

R_0 is a constant. B_1 and B_0 are determined from S_2 and S_3 in connexion with the Calibration Curve B. Therefore W may be computed. W and V are thus determined and provide the necessary data for plotting the total visibility as a function of the weather condition, which may then be compared with the theoretical curves shown in fig. 3. If the objects on which the measurements were made were of the same colour as the background (the visibility being entirely due to brightness contrast) those experimental curves should coincide with the theoretical ones applying to the same conditions. If a colour (either hue or saturation) difference exist, the difference between the measured and computed values will be the part of the total visibility due to quality contrast. In this way the form of the expression $V_q = f(W)$ may be evaluated graphically,

$$B_t = B_v' + B_1 \cdot (T_a \cdot T_m) \dots \dots \dots (15)$$

By computing the value of B_t by this equation for various scale readings its constancy or variation can be determined. This will show, in connexion with fig. 2, whether or not k remains constant and if not will provide the required data for the determination of its value. Thus any error introduced by a variation of k may be eliminated.

Attention should again be called to the analogy between the method employed in the instrument for reducing the visibility to a zero value and the phenomenon of lowered visibility in nature. Given an object seen against the sky and at some distance from the observer. Now let a cloud or mist or any collection of small material particles be formed

in the foreground space of such concentration or density that the object is just visible. In the terminology previously adopted we may state this condition by the equation

$$\frac{(B_1 \cdot T_d) + P_d}{(B_2 \cdot T_d) + P_d} = c. \quad \dots \quad (16)$$

In the instrument the condition when a visibility setting is made is given by

$$\frac{B_1 + B_v}{B_2 + B_v} = c,$$

where $B_v = \frac{B_v'}{T_a \cdot T_m},$

$$\therefore \frac{B_1(T_a \cdot T_m) + B_v'}{B_2(T_a \cdot T_m) + B_v'} = c. \quad \dots \quad (17)$$

Equations (16) and (17) are of exactly the same form. The term T_d in (16), which is the transmission of the foreground space, is replaced in (17) by $(T_a \cdot T_m)$, the transmission of the wedge and mirror of the instrument. The term P_d in (16), which is the brightness due to light reflected or refracted by the particles in the foreground space, is replaced in (17) by B_v' , the brightness of the glare field of the instrument. The constant c is the same in both cases, being equal to

$$k \text{ or } \frac{1}{k},$$

depending upon whether B_1 is greater or less than B_2 .

As was pointed out previously the exact relation between the values of T and P varies greatly with the nature of the particles producing the diffusion in the foreground space.

Since the relation is subject to so much variation no attempt was made in the design of the instrument to imitate any particular kind of natural fog or haze. Another factor, however, must be considered in fixing the relation of B_v' to $(T_a \cdot T_m)$, this being the necessity for keeping the total field brightness ($B_t = B_v' + B_1(T_a \cdot T_m)$) practically constant for all possible values of the scale reading. Another point requiring consideration was the necessity for keeping the light source sufficiently small, with respect to voltage and current consumption, to permit of convenient operation by easily portable batteries.

A large amount of data relative to the visibility of objects

has been obtained; the greater part of this refers to the visibility of small boat models camouflaged in various ways. As was previously stated, it is not the object of this paper to present the results of this work. However, in order to convey a more definite idea of the performance of the visibility meter a single set of data and one pair of curves will be included. In Table I., under the heading F 20, are

TABLE I.

F 20.		$R_2 = .43.$	
W.	V.	W.	V.
·40	1·5+	·10	81·5+
·47	2·5—	·20	27·8+
·70	10·0—	·25	17·0+
·90	11·5—	·30	9·9+
·30	12·5+	·35	4·6+
·34	5·0+	·40	0·9+
·25	2·5+	·414	0·0
·42	2·5+	+0	0·0
·38	4·0+	·447	0·0
·55	5·5—	·50	2·6—
·42	0·9+	·60	6·3—
·45	1·0—	·70	9·0—
·78	9·0—	·80	11·0—
·35	8·5+	·90	12·6—
·50	3·0—	1·00	13·8—

given the visibility values, V, for various weather coefficients, W. The model used was painted a flat bluish-green gray and was of the lowest average visibility for the period covered by the observations. The specifications of colour and reflecting power for this model are :

Reflexion Factor.....	·43
Wave-Length of Dominant Hue ...	488 $\mu\mu$
Saturation	88 p. c. white.

Many more observations than are given in Table I. were made but those presented are considered as typical and cover the maximum range of W values encountered. In the columns under the heading $R_2 = .43$ are the theoretical values of V corresponding to a series of assumed values for W, and $R_2 = .43$. The observed and computed values are plotted in fig. 13. The fact that the minimum visibility of the model F 20 was practically zero shows that the hue contrast, C_h , and saturation contrast, C_s , between model and background must

have been very small. Hence the curve plotted from the observed values should agree quite closely with the theoretical curve $V=f(W)$ for brightness contrast alone. It will be noted that the curves agree fairly well in the region

Fig. 13.

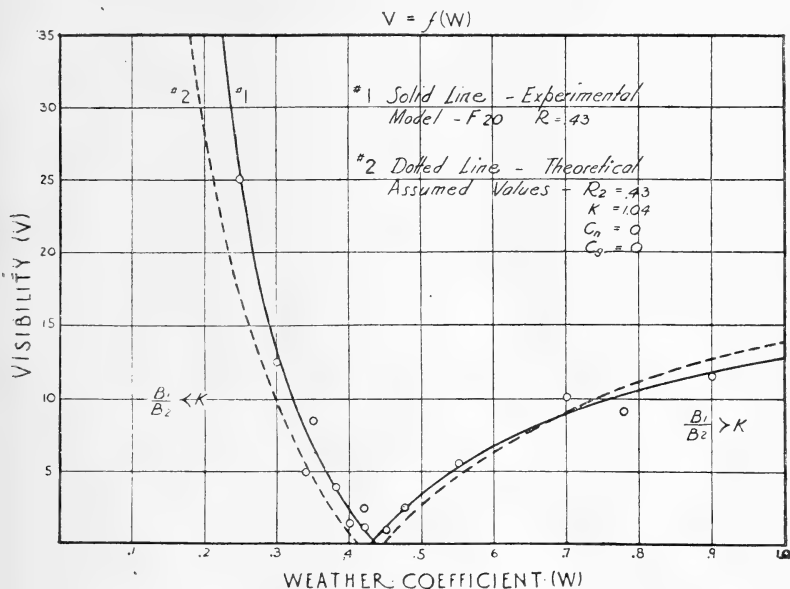

Comparison of Observed with Computed Values.

$W = .45$ to $W = .90$, but that more marked differences exist for lower values of W . This is probably due to the presence of quality contrast which existed to a greater extent under those weather conditions resulting in low values of W . Such values of W usually denote clear sky and bright sunlight, and although the colour of the background may be constant, the apparent colour of the object will be changed, due to the difference in quality of the incident illumination.

Although the greater part of the work done with this instrument relates to the visibility of ships as seen against a sky background it is evident that the same method can be applied to the evaluation of the visibility of other objects under various conditions of background and illumination. While it is considered that the general principles of the method are applicable to all problems of this nature it is

recognized that its use in other cases may require modification of the details of the instrument, experimental procedure, and of the reduction of the data to the most useful form.

One problem to which this method has already been applied with considerable success is the measurement of the increase or decrease in the visibility of objects resulting from the use of colour filters. The change of visibility in such cases is obtained by the adjustment of the selective absorption to fit the requirements and the condition under which they are used. The enhancement of visibility by use of colour filters usually depends upon their ability to increase either the hue or saturation contrast or both. The increase of visibility in such cases can be determined quantitatively by first making one reading in the usual way without a filter and one after having inserted the filter between W and L_1 (fig. 7).

The complete interpretation of such results requires an extension of the theory to cover the evaluation of visibility in terms of hue and saturation contrast and cannot be presented at this time. In conclusion, the author desires to express his sincere thanks to Dr. C. E. K. Mees and to Mr. Lindon W. Bates for their many helpful suggestions and constant encouragement given through the course of this investigation.

Research Laboratory,
Eastman Kodak Company,
April 21, 1919.

IX. *A Note on the Equivalent Shell of a Circular Current.*
By SATYENDRA RAY, M.Sc., B.A., Lecturer in Physics,
Canning College, and Senior Science Master, La Martiniere
College, Lucknow*.

§ 1. *Introduction.*

THE magnetic induction of a circuit at any point is identical in magnitude and direction with that due to a magnetic shell bounded by the circuit, the strength of the shell being numerically equal to the current. The equivalence is, however, true only for points not close to the magnetic shell. [*Vide* Maxwell's 'Electricity and Magnetism,' vol. ii. §§ 482-484.]

The shell is defined as magnetic matter magnetized in a direction everywhere normal to its surface. This together with the law of refraction of lines of induction, viz. $\frac{\tan \theta_1}{\mu_1} = \frac{\tan \theta_2}{\mu_2}$, and the law that for a tube of induction

* Communicated by Prof. D. N. Mallik, Sc.D., F.R.S.E.

$B \times S$ is constant, imposes certain conditions on the equivalent shell, if we are to get the proper direction and magnitude of the induction at all points.

For instance, it is clear the shell cannot be of the form shown in thick continuous line in fig. 1. The inductions at

Fig. 1.

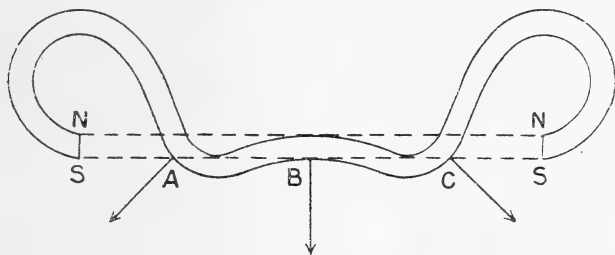

A, B, and C are entirely different in direction and line of action from that of the slab indicated by dotted lines, although the magnitude in both cases is the same and equal to $4\pi N$.

It is, *a priori*, evident that the equivalence can be extended to all points in space, (1) by making the rim of the magnetic shell a *line* instead of a cylinder as in fig. 1, and (2) by

Fig. 2.

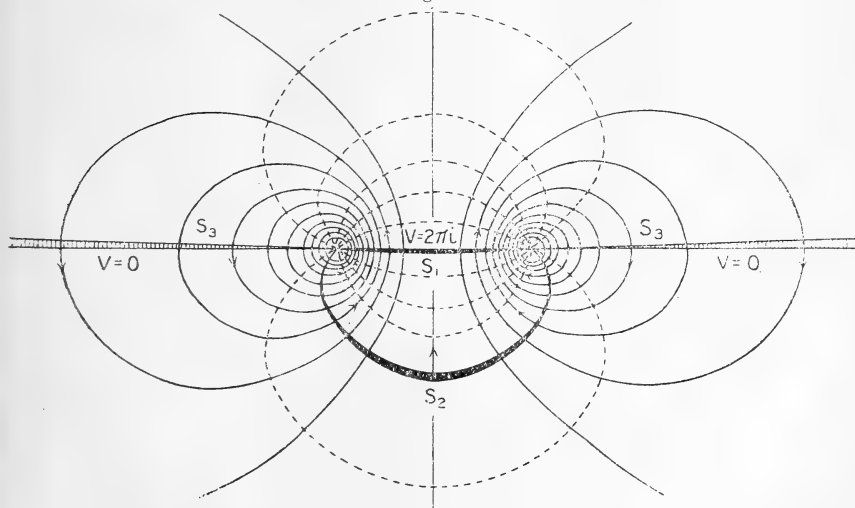

making the two surfaces of the shell coincide with two equipotential surfaces close to each other as in S_1 , S_2 , and S_3 in fig. 2. We can still choose the equivalent shell in an infinite number of ways, although we cannot make it pass

any how. The thickness decreases from the axis to the rim, and therefore the intensity of magnetization of shell increases, becoming infinite at the rim. The line rim prevents inversion of the direction of magnetization of the shell shown in fig. 1, which, it will be noticed, cannot be got rid of by making the shell indefinitely thin.

As tubes of magnetic induction form closed curves encircling the current, and as for each tube of induction $B \times S$ is constant, from the above mode of choosing the equivalent shell, we get immediately the relation that $\int B dS$ taken over any equipotential surface bounded by the rim is constant. Or, the Total Magnetic Pole on the surface of the equivalent magnetic shell is constant, no matter how we choose the equivalent shell.

§ 2. Total Magnetic Pole.

To find this Total Magnetic Pole, $\int \sigma dS$, on the surface of the Magnetic Shell we shall find that the plane surface through the rim gives us the best equipotential surfaces to choose. One equipotential surface extends from the centre to the rim, the other from the rim to infinity. For the first of these,

$$V = -2\pi i \left\{ 1 + \frac{r}{a} \cdot P_1(\theta) + \&c. \right. \\ \left. + \frac{1 \cdot 3 \dots (2n-1)}{2 \cdot 4 \dots 2n} \cdot \frac{r^{2n+1}}{a^{2n+1}} P_{2n+1}(\theta) + \&c. \right\}. \\ \text{(Maxwell, Vol. ii. Art. 695.)}$$

For the plane of the coil $\theta = \frac{\pi}{2}$, so that all the harmonics in the series vanish and $V = 2\pi i$, a constant. H is therefore perpendicular to the plane of the circuit.

$$H = -\frac{dV}{rd\theta} = -\frac{dV}{rd\mu} \cdot \frac{d\mu}{d\theta} \\ = \frac{dV}{rd\mu} \quad \text{as } \theta = \frac{\pi}{2};$$

Therefore

$$H = -\frac{2\pi i}{a} \left\{ \frac{dP_1(\theta)}{d\mu} - \frac{1}{2} \cdot \frac{r^2}{a^2} \cdot \frac{dP_3(\theta)}{d\mu} + \frac{1 \cdot 3}{2 \cdot 4} \cdot \frac{r^4}{a^4} \cdot \frac{dP_5(\theta)}{d\mu} - \&c. \right\} \\ = -\frac{2\pi i}{a} \left\{ 1 + \left(\frac{1}{2}\right)^2 \frac{3r^2}{a^2} + \left(\frac{1 \cdot 3}{2 \cdot 4}\right)^2 \frac{5r^4}{a^4} + \left(\frac{1 \cdot 3 \cdot 5}{2 \cdot 4 \cdot 6}\right)^2 \frac{7r^6}{a^6} + \&c. \dots \right\} \quad \mu=0$$

As H is constant when r is constant,

$$\begin{aligned} \int BdS &= \mu \int HdS = \mu \int_0^a H \cdot 2\pi r \cdot dr \\ &= -\frac{4\pi^2\mu i}{a} \int_0^a \left\{ r + \left(\frac{1}{2}\right)^2 \cdot \frac{3r^3}{a^2} \right. \\ &\quad \left. + \left(\frac{1 \cdot 3}{2 \cdot 4}\right)^2 \cdot \frac{5r^5}{a^4} + \left(\frac{1 \cdot 3 \cdot 5}{2 \cdot 4 \cdot 6}\right)^2 \cdot \frac{7r^7}{a^6} + \&c. + \right\} dr \\ &= -4\pi^2\mu ai \left\{ \frac{1}{2} + \left(\frac{1}{2}\right)^2 \cdot \frac{3}{4} \right. \\ &\quad \left. + \left(\frac{1 \cdot 3}{2 \cdot 4}\right)^2 \cdot \frac{5}{6} + \left(\frac{1 \cdot 3 \cdot 5}{2 \cdot 4 \cdot 6}\right)^2 \cdot \frac{7}{8} + \&c. \right\}. \quad (i.) \end{aligned}$$

[For the supplementary equipotential surface extending from the rim to infinity

$$\begin{aligned} V &= 2\pi i \left\{ \frac{1}{2} \frac{a^2}{r^2} P_1(\theta) + \&c. + \frac{1 \cdot 3 \cdot (2n+1)}{2 \cdot 4 \dots 2n} \cdot \frac{a^{2n+2}}{r^{2n+2}} P_{2n+1}(\theta) + \&c. \right\} \\ &= 0. \text{ as } \theta = \frac{\pi}{2}; \end{aligned}$$

\therefore

$$H = 2\pi i \left\{ \left(\frac{1}{2}\right)^2 \cdot \frac{2a^2}{r^3} + \left(\frac{1 \cdot 3}{2 \cdot 4}\right)^2 \cdot \frac{4a^4}{r^5} + \left(\frac{1 \cdot 3 \cdot 5}{2 \cdot 4 \cdot 6}\right)^2 \cdot \frac{6a^6}{r^7} + \dots \&c. \right\},$$

and

$$\begin{aligned} \int BdS &= \mu \int_a^\infty H \cdot 2\pi r \cdot dr = 4\pi^2\mu ai \left\{ \frac{1}{2} + \left(\frac{1}{2}\right)^2 \cdot \frac{3}{4} \right. \\ &\quad \left. + \left(\frac{1 \cdot 3}{2 \cdot 4}\right)^2 \cdot \frac{5}{6} + \left(\frac{1 \cdot 3 \cdot 5}{2 \cdot 4 \cdot 6}\right)^2 \cdot \frac{7}{8} + \&c. \right\}. \end{aligned}$$

This is numerically identical with (i.), the difference in sign being due to the south face of the equivalent shell being turned towards the normal instead of the north face.]

In (i.) the radius of the coil is involved. If, however, we think of the current as being constituted by a total electric charge e moving round the coil with a linear velocity v ,

$$i = \frac{v}{2\pi a} \cdot e,$$

$$\begin{aligned} \therefore \int BdS &= 2\pi\mu ve \left\{ \frac{1}{2} + \left(\frac{1}{2}\right)^2 \cdot \frac{3}{4} \right. \\ &\quad \left. + \left(\frac{1 \cdot 3}{2 \cdot 4}\right)^2 \cdot \frac{5}{6} + \left(\frac{1 \cdot 3 \cdot 5}{2 \cdot 4 \cdot 6}\right)^2 \cdot \frac{7}{8} + \dots \&c. \right\}, \end{aligned}$$

which is independent of a .

Defining "magnetic polarization" in a manner analogous to "electric polarization" as $\frac{B}{4\pi}$ and representing it by σ , and calling $\int \sigma dS$ for the whole of the equipotential surface m , the Total Magnetic Pole, we have

$$\int \sigma dS = \mu v e \cdot \frac{1}{2} \left[\frac{1}{2} + \left(\frac{1}{2}\right)^2 \cdot \frac{3}{4} + \left(\frac{1 \cdot 3}{2 \cdot 4}\right)^2 \cdot \frac{5}{6} + \left(\frac{1 \cdot 3 \cdot 5}{2 \cdot 4 \cdot 6}\right)^2 \cdot \frac{7}{8} + \dots \&c. \right],$$

or

$$m = A \mu v e \dots \dots \dots (ii.)$$

where

$$A = \frac{1}{2} \left[\frac{1}{2} + \left(\frac{1}{2}\right)^2 \cdot \frac{3}{4} + \left(\frac{1 \cdot 3}{2 \cdot 4}\right)^2 \cdot \frac{5}{6} + \left(\frac{1 \cdot 3 \cdot 5}{2 \cdot 4 \cdot 6}\right)^2 \cdot \frac{7}{8} + \dots \&c. \right].$$

The series represented by A is a constant. We can call it Ampère's Number. Physically we may define it as the Magnetic Equivalent of Electricity, being the value of m produced by unit electric charge moving with unit velocity in a circle inside a medium of unit permeability.

It will be noticed m is finite although H is infinite when $r = a$.

§ 3. Total Stress Energy.

In terms of $\int B dS$ for the surface of the equivalent magnetic shell the Total Stress Energy in the Magnetic Field can be easily calculated. Integrating, tube by tube, from the equipotential surface $V = 2\pi i$, to the equipotential surface $V = 0$, we have, if l is length of tube of induction parallel to H,

$$\begin{aligned} \iiint \frac{\mu H^2}{8\pi} \cdot dx \cdot dy \cdot dz &= \iint \frac{\mu H^2}{8\pi} \cdot dS \cdot dl \\ &= \frac{1}{8\pi} \iint B dS \cdot dV ; \end{aligned}$$

∴

$$\begin{aligned} \int_{-\infty}^{\infty} \int_{-\infty}^{\infty} \int_{-\infty}^{\infty} \frac{\mu H^2}{8\pi} \cdot dx \cdot dy \cdot dz &= 2 \cdot \frac{1}{8\pi} \int_{\theta=0, r=0}^{\theta=0, r=a} B dS \cdot \int_0^{2\pi i} dV \\ &= 4\pi^2 A \mu a i^2 \\ &= A \frac{\mu e^2 v^2}{c} \dots \dots \dots (iii.) \end{aligned}$$

The similarity of the expression obtained for the Total Stress Energy with the Kinetic Energy of the æther produced by motion of a charged sphere is noteworthy.

§ 4. *The Magnetic Analogue.*

The magnetic analogue of the circular electric current was experimentally tried. A flywheel with a rim of circular cross-section mounted on "single-ball" bearings was magnetized by an electric current so as to have its north pole at the two ends of the axle, the south pole being distributed mainly along the axis of the circular rim. Two brushes

Fig. 3.

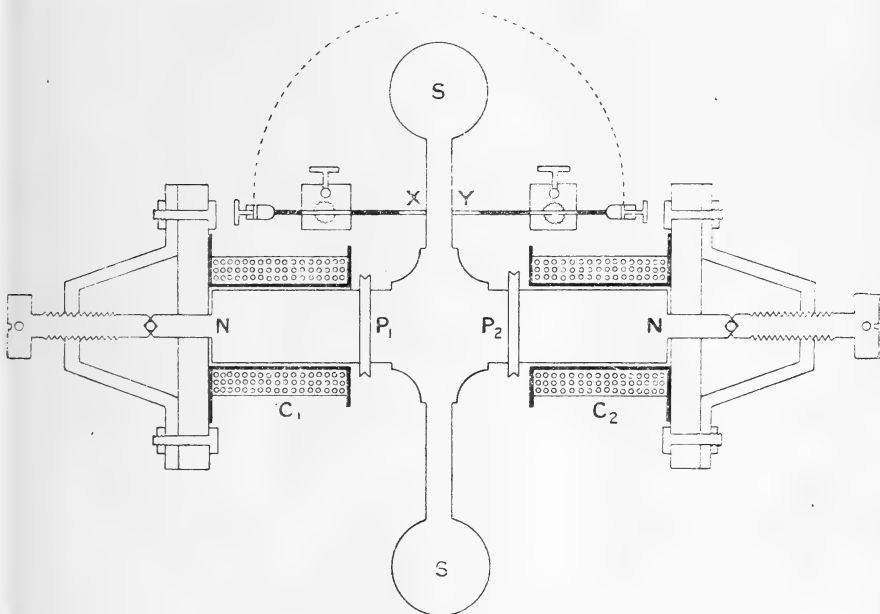

made contact with the two sides of the flywheel, and a circuit was completed through a sensitive dead-beat galvanometer. The deflexion increased with the speed of rotation and with the "magnetic current" threaded by the circuit, increasing to a maximum when the contact was near the neutral line of the rotating magnet and decreasing to zero when the contact was made with the centre of the screw-heads. The deflexion reversed in direction with reversal of the "magnetic current."

The current may no doubt be explained from ordinary

laws of induction. Assuming the plane of the electric circuit to pass through the axis of the flywheel, every tube of induction that enters the circuit through the cast iron between X and Y, where the brushes make contact, goes out of it between the same two points from the rest of the circuit. Also from symmetry of the magnetic field about the axis of the flywheel the number of tubes of induction moving across XY in the cast iron is exactly equal to the number of the tubes of induction moving across the rest of the circuit at right angles to the plane of the circuit. The tubes sweep longitudinally across the plane of the electric circuit, and the E.M.F. between X and Y in the cast iron is equal to the E.M.F. between Y and X in the rest of the circuit and the direction is continuous.

In the analogue we get closed tubes of electric induction, and it is easier to calculate the induced E.M.F. in the circuit, in a form analogous to the expression $4\pi i$ for the magnetomotive force round a magnetic circuit threaded by an electric current, by regarding the rotating flywheel carrying a negative magnetic charge as constituting a "magnetic current" threading the electric circuit.

Assuming a magnetic charge in motion to constitute a "magnetic current element" obeying Laplace's rule, the electric intensity at any point of a circular coil of radius a and of resistance R , due to a magnetic pole m moving along the axis of the coil, can be put in the form

$$F = k \cdot m \cdot \frac{ds}{dt} \cdot \frac{1}{r^2} \cdot \sin \theta,$$

r being the distance of m from coil, θ the angle between r and the axis of the coil. We have, therefore, from definition:

Induced E.M.F.

$$\begin{aligned} &= k \cdot 2\pi a \cdot m \cdot \frac{ds}{dt} \cdot \frac{1}{r^2} \cdot \sin \theta \\ &= k \cdot 2\pi a \cdot m \cdot \frac{\sin \theta}{a} \cdot \frac{d\theta}{dt}, \end{aligned}$$

and Induced Current

$$= k \cdot \frac{2\pi m}{R} \cdot \sin \theta \cdot \frac{d\theta}{dt};$$

$$\begin{aligned} \therefore \int_0^\infty i dt &= k \cdot \frac{2\pi m}{R} \cdot \int_0^\pi \sin \theta d\theta, \\ &= k \cdot \frac{4\pi m}{R}. \end{aligned}$$

Now, we know, the whole charge q passing any section of a closed circuit as the magnetic induction threading it changes from zero to N , is $-\frac{N}{R}$.

$$\therefore k \cdot \frac{4\pi m}{R} = -\frac{N}{R}$$

or $k = -1$.

Also, as N due to pole m threading the circuit when the semi-vertical angle subtended by the coil is θ , is given by the relation

$$N = 4\pi m \cdot \frac{2\pi(1 - \cos \theta)}{4\pi} \\ = 2\pi m \cdot (1 - \cos \theta),$$

we can easily see that, if $k = -1$, the induced E.M.F.

$$E = 2\pi m \cdot \sin \theta \cdot \frac{d\theta}{dt} \\ = -\frac{dN}{dt}$$

This shows Laplace's law may be taken to be true for the "magnetic current," as much as for the electric current, only the directions of the magnetic current and the electro-motive force are related by a *left-handed* cork-screw rule, This would then give the expression for the electric induction at points in the plane of the *circular* "magnetic current" in a form similar to that for the magnetic induction due to an electric current. We should get an Equivalent Dielectric Shell, subject to the same conditions as the Equivalent Magnetic Shell, satisfying the relation

$$e = AKvm \dots \dots \dots (iv.)$$

and the Total Stress Energy in the Electric Field would be given by the relation

$$\int_{-\infty}^{\infty} \int_{-\infty}^{\infty} \int_{-\infty}^{\infty} \frac{KR^2}{8\pi} \cdot dx \cdot dy \cdot dz = A \frac{Km^2v^2}{a} \dots \dots (v.)$$

§ 5. Evaluation of A.

From available tables the value of A to 81 terms has been found by Messrs. Joshi and Sinha to be .914336179. The series, however, is very slowly convergent and the sum to a much higher number of terms is necessary.

The value of A could be found from the coefficient of Self-Induction L , which by definition is the value of $\int B dS$ when $i=1$. We have the equation

$$L = 8\pi^2 \mu A a$$

for finding A in terms of L or *vice versa*. But L for a circular conductor of one turn is given by Fleming for a wire of diameter d in the form

$$L = 4\pi a \left\{ \log \frac{8\pi a}{d} - 2.2 \right\}.$$

The formula makes L infinitely great when d approaches zero, as in our investigation, so that the formula fails us. Of course the value of d to choose is the diameter of the Electron. If d were not involved we could determine A at least experimentally by finding L . If $A=V$ the diameter of the electron would be of the order $10^{-4.3 \times 10^{11}}$ cm.

The idea of Equivalence may help us to form an idea of the order and magnitude of A as follows.

A circular row of electrons of total charge e moving round with a velocity v in a medium of permeability μ gives us an equivalent magnetic shell on the face of which the pole m is equal to $A\mu ve$. The pole density is infinite at the rim, so that we shall imagine this pole to be distributed along the circle itself.

The error in making the equivalent magnetic ring coincide with the electric circuit is very small as the true radius is

$$\frac{\int_0^a \mu H \cdot 2\pi r \cdot dr \cdot r}{\int_0^a \mu H \cdot 2\pi r \cdot dr} = a \cdot \frac{\frac{1}{3} + \left(\frac{1}{2}\right)^2 \cdot \frac{3}{5} + \left(\frac{1.3}{2.4}\right)^2 \cdot \frac{5}{7} + \left(\frac{1.3.5}{2.4.6}\right)^2 \cdot \frac{7}{9} + \&c.}{\frac{1}{2} + \left(\frac{1}{2}\right)^2 \cdot \frac{3}{4} + \left(\frac{1.3}{2.4}\right)^2 \cdot \frac{5}{6} + \left(\frac{1.3.5}{2.4.6}\right)^2 \cdot \frac{7}{8} + \&c.}$$

The numerator in the right-hand expression is less than the denominator but the difference is less than $\frac{1}{2}$, so that if A is large the radius of the equivalent ring is equal to a for all practical purposes.

The magnetic analogue similarly means that a circular line distribution of pole m , moving with a velocity v in a direction opposite to above, in a medium of inductivity K , is equivalent to a dielectric ring at rest, coinciding with the magnetic current, the charge on its two faces being $AKvm$. A reciprocal relation exists, a current of one kind being equal to a doublet of the other kind coincident with it.

To explain a doublet does not, as we know, require postulation of two kinds of charges, electric or magnetic, positive

and negative charges being completely explained by the notion of "displacement." Taking a positive electric ring and a positive magnetic ring coincident with one another, the electric current corresponds to the whirling round of the electric ring attended by a displacement of the magnetic ring as in fig. 4 *a*. The magnetic current corresponds to the whirling round of the magnetic ring attended by a displacement of the electric ring as in fig. 4 *b*. An inspection of the

Fig. 4.

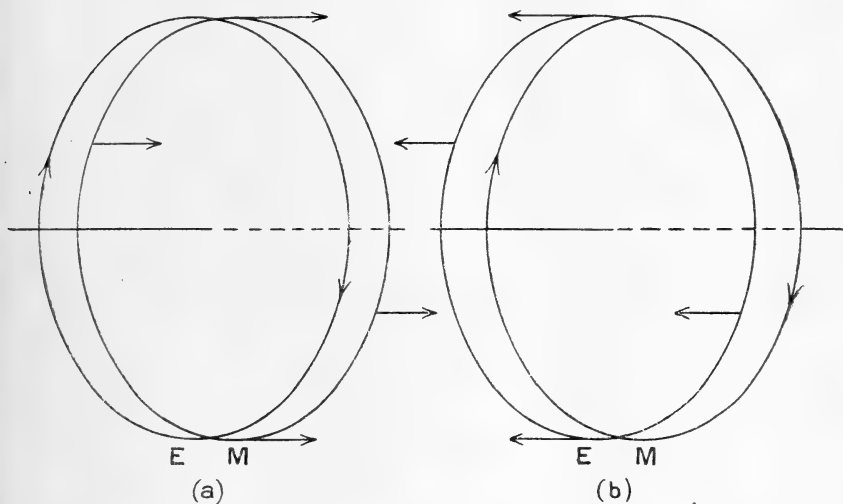

figure will show that both the cases are essentially identical, being the case of an electric and a magnetic ring spinning round in directions opposite to one another and pulled apart by the spinning. The displacement and therefore the static charge is proportional to the velocity and so is the current. In the electric current we view the system magnetostatically and in the magnetic current electrostatically.

If m_0 and e_0 be the static charges when $v=1$, the force of attraction between two such identical systems of "electromagnetic doublets" of infinitely small radius placed 1 cm. apart,

$$F = -\frac{e_0^2}{K} + C \frac{m_0^2 r^2}{\mu},$$

or

$$= -\frac{m_0^2}{\mu} + C \frac{e_0^2 v^2}{K},$$

according as we treat the systems electrostatically or magnetostatically. C is a function of the radius of the rings

and v is equal to unity. Forces between rings of the same kind alone come in, forces between electric and magnetic rings cancelling each other if the displacement is very small.

Equating the two expressions

$$\frac{e_0^2}{K} = \frac{m_0^2}{\mu} = \frac{e_0 m_0}{\sqrt{\mu K}},$$

from which we immediately get

$$\begin{aligned} e_0 &= \sqrt{K} m_0 \\ \text{and} \quad m_0 &= \sqrt{\mu} e_0. \end{aligned}$$

Comparing these with our equivalence formulæ we see $A = V$. Also,

$$\frac{e_0^2}{m_0^2} = \frac{K}{\mu}$$

$$\text{or} \quad \frac{e}{\sqrt{K}} = \frac{m}{\sqrt{\mu}} \dots \dots \dots \text{(vi.)}$$

which is the ultimate equivalence formula*.

§ 6. *Conclusion.*

If the above be true we may develop our conception of the system of electromagnetic ring doublets of which the electric and magnetic currents are relative aspects. We may conceive the two rings as elastic and as spinning round opposite to each other and continually threading each other. The spinning supplies the motive power for the threading, the distance apart between two corresponding portions of the two rings pursuing each other depending on the velocity.

It appears the pole may be taken as the fundamental physical entity just as the electron. The diameter of the electron from Fleming's formula comes out to be of the order $10^{-4.3 \times 10^{11}}$ cm. The electron or the magnetic pole may be an "electromagnetic doublet" of corpuscles of this diameter.

If we assume an electric and a magnetic fluid to fill all space, the "electromagnetic doublet" may be regarded as an electric and a magnetic vortex, having the same rectilinear and circular axes and spinning in opposite directions, superposed on one another. These two vortical motions

* See Lodge's 'Electrons,' Appendix C.

seem to be the two aspects of the motion of a single fluid related by the equivalence equation

$$\frac{e}{\sqrt{K}} = \frac{m}{\sqrt{\mu}}.$$

The relations $m \propto \mu v e$ and $e \propto K v m$ were indicated in a paper submitted by the present writer to the Science Convention, Calcutta, 2nd March, 1919. Dr. D. N. Mallik's opinion that it would demonstrate that the electron was a vortex formed a great incentive for trying the magnetic analogue of the circular electric current. I am obliged to Messrs. N. V. Joshi, B.Sc., and Ram Chandra Sinha of Canning College, for aid in setting up the apparatus and taking observations.

Lucknow, India,
7th June, 1919.

X. *On the Sounds of Splashes.*

By Prof. C. V. RAMAN, M.A., and ASHUTOSH DEY*.

[Plate 1.]

IN his interesting book on splashes†, the late Prof. Worthington described the results of an extensive series of photographic studies of the phenomena accompanying impact on a liquid surface. The successive stages of the splash of a drop for various heights of fall, and the splashes produced by solid spheres impinging on a liquid surface, were all fully investigated and described. Prof. Worthington showed that the splashes produced by solid spheres are of two kinds, the "smooth" or "sheath" splash, and the "rough" or "basket" splash; whether the one or the other kind of splash is produced depends on the condition of the surface of the sphere, the height of fall, and the nature of the liquid. The "smooth" splash is practically noiseless, and the "rough" splash is noisy and violent. In the latter case, it was observed by Prof. Worthington that the sphere when entering the liquid drags the air down with it, forming a cavity in its wake, and the successive changes in the form of this cavity, its bifurcation, and the formation of vertical jets of liquid within and above the cavity are beautifully illustrated in his book by a series of instantaneous

* Communicated by the Authors.

† 'A Study of Splashes,' Longmans, Green & Co., 1908. The book contains (with some additions) the substance of two papers by Worthington and Cole, Phil. Trans. Roy. Soc. 1897 and 1900.

photographs. In a recent paper* Mr. A. Mallock has attempted to develop a mathematical theory of the formation of the air-cavity in the wake of the sphere, and he has also discussed the part played by it in the production of the characteristic sound accompanying the splash. Mr. Mallock's observations of the sounds of splashes were made with the unaided ear, and are thus of a subjective and qualitative character. Further investigation with instrumental aid is obviously desirable†.

The present communication is accompanied by some photographic records of the *sounds* of splashes which the authors have secured, showing the transition between the "smooth" or "sheath" splash and the "rough" or "basket" splash, depending on the condition of the surface of the impinging sphere. A brief description of the instrument with which the sound records were secured may be of interest, as it has proved very convenient and easy to construct, and also sufficiently sensitive. The design of the instrument is due to Dr. P. H. Edwards‡, who gave a sketch of it in a personal communication to one of the authors. The essential features of the apparatus are shown in the diagrams (a) and (b). The sound-waves enter a horn at the end of which a mica disk is fixed. To the centre of this disk is firmly fixed a steel spring which projects normally from the disk. This spring presses upon a fine steel needle resting on supports, and when the mica disk vibrates to and fro, the movement of the spring causes the needle to roll forward and backward on its supports. By means of the screw shown in (a), the pressure of the spring on the needle can be suitably regulated. To ensure the needle always remaining parallel to itself, the supporting block is made slightly curved to a cylindrical shape and cut away at the centre as shown in (b). The angular movement of the needle caused by its rolling is greatly magnified and optically recorded on the moving photographic plate with the aid of a

* Proc. Roy. Soc. vol. xcv., November 1918. Mr. Mallock quotes only the Phil. Trans. paper of 1897, and was apparently unaware of Worthington's later work.

† An interesting fact which may be mentioned in this connexion and which requires investigation, is that the splash of a liquid drop is practically soundless unless the height of fall exceeds a certain minimum. This effect appears to be connected with the change in the character of the splash with increasing heights of fall noticed by Worthington.

‡ Dr. Edwards used an instrument of the type mentioned in the course of some recent work at the Bureau of Standards at Washington, the results of which work still await publication.

tiny fragment of silvered mirror cemented to the needle as shown in (b).

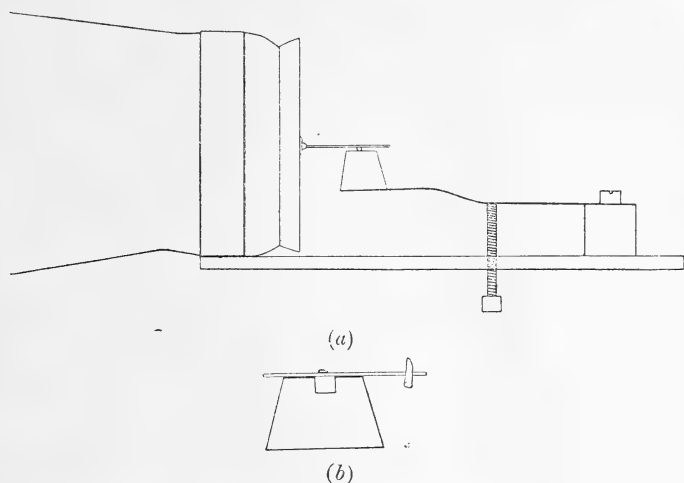

Fig. 1 in the Plate shows the record obtained when a highly polished steel sphere 2 cm. diameter was allowed to fall 100 cm. on to the surface of water. The record is a straight line, showing that the splash was soundless. Figs. 2 and 3 were obtained with the same sphere and height of fall, when the surface of the steel was dimmed with a touch of grease. The two records are closely similar, and show that sounds were produced at two different stages of the splash with an interval of distinct silence separating them. An interesting contrast with figs. 1, 2, and 3 is furnished by fig. 4, which is the record of the sound of a "basket" splash produced by the fall of a steel sphere of the same diameter through the same height, the difference being that in the present case the surface of the steel sphere had been roughened by allowing it to rust. It will be noticed that there is a stage at which there is a violent disturbance, this being due to the characteristic sound of the "basket" splash. Figs. 5 and 6 are also records of the sounds of "basket" splashes produced by the fall of wooden spheres 10 cm. diameter from a height of 100 cm. The striking difference between the intensity of the sounds indicated by the records in the two cases was due to a slight difference in the condition of the surfaces of the two spheres.

The authors hope, when a suitable opportunity arises, to continue the study of the sounds of splashes of which the preliminary results are contained in the present note.

Calcutta, 8th July, 1919.

XI. On Fresnel's Convection Coefficient.

By Prof. A. ANDERSON*.

THE condition that the laws of refraction and reflexion of light shall hold for media in uniform motion with reference to a supposed stationary æther, the index of refraction being independent of the velocity, has been obtained in various ways. The following method is merely an application of Huygens' construction.

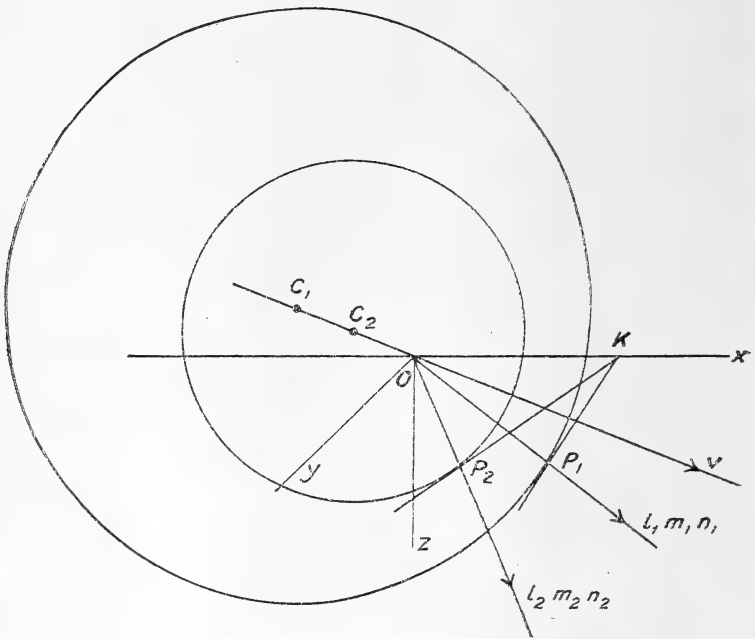

Oz is the trace of the plane bounding surface of the two media which are moving with velocity v in the plane of the paper relative to a stationary æther. When $v=0$, let the velocity of light in the upper medium be c_1 and that in the lower c_2 , and suppose that in the actual case the relative velocities in the two media are given by the vector differences $c_1 - v_1$ and $c_2 - v_2$.

Let O be a point in the bounding surface, and let C_1O be the direction of v in the plane of the paper. Take $OC_1 = v_1$ and $OC_2 = v_2$, and with centres C_1 and C_2 describe spheres whose radii are respectively c_1 and c_2 . Take O as origin of

* Communicated by the Author.

co-ordinates, and let Ox in the plane of the paper, Oy perpendicular to the plane of the paper, and Oz be the rectangular axes. Thus the normal to the refracting surface is Oz . Draw any line through O representing the incident ray whose direction cosines are l_1, m_1, n_1 , and let it meet the sphere whose centre is C_1 in P_1 . In like manner draw another line representing the refracted ray whose direction cosines are l_2, m_2, n_2 , and meeting the other sphere in P_2 . The points P_1 and P_2 are, of course, not generally in the plane of the paper. If, now, tangent planes be drawn to the spheres at P_1 and P_2 , they must intersect in a line lying in the plane of xy .

We now assume that $v_1 = \kappa_1 v$ and $v_2 = \kappa_2 v$, and in the work squares of v_1 and v_2 will be neglected. Let the angle $xOv = \phi$.

We have $OP_1 = C_1 - v_1(l_1 \cos \phi + n_1 \sin \phi)$,

and the co-ordinates $\alpha_1, \beta_1, \gamma_1$ of P_1 are

$$\begin{aligned} \alpha_1 &= c_1 l_1 - v_1 l_1 (l_1 \cos \phi + n_1 \sin \phi), \\ \beta_1 &= c_1 m_1 - v_1 m_1 (l_1 \cos \phi + n_1 \sin \phi), \\ \gamma_1 &= c_1 n_1 - v_1 n_1 (l_1 \cos \phi + n_1 \sin \phi). \end{aligned}$$

In like manner the co-ordinates $\alpha_2, \beta_2, \gamma_2$ of P_2 are

$$\begin{aligned} \alpha_2 &= c_2 l_2 - v_2 l_2 (l_2 \cos \phi + n_2 \sin \phi), \\ \beta_2 &= c_2 m_2 - v_2 m_2 (l_2 \cos \phi + n_2 \sin \phi), \\ \gamma_2 &= c_2 n_2 - v_2 n_2 (l_2 \cos \phi + n_2 \sin \phi). \end{aligned}$$

On writing down the equation of the tangent plane at P_1 we find that it meets the plane of xy in the line

$$x \left(\frac{l_1}{c_1} + \frac{v_1 \cos \phi}{c_1^2} \right) + y \frac{m_1}{c_1} = 1,$$

and that the tangent plane at P_2 meets the plane of xy in the line

$$x \left(\frac{l_2}{c_2} + \frac{v_2 \cos \phi}{c_2^2} \right) + y \frac{m_2}{c_2} = 1.$$

We thus have

$$\frac{m_1}{m_2} = \frac{c_1}{c_2} = \frac{\mu_2}{\mu_1} = \mu,$$

where μ_1 is the absolute index of refraction of the first medium and μ_2 that of the second, μ being the index of refraction from the first medium to the second.

We have, also,

$$\frac{l_1 + \frac{v_1 \cos \phi}{c_1}}{l_2 + \frac{v_2 \cos \phi}{c_2}} = \frac{c_1}{c_2} = \frac{\mu_1}{\mu_2} = \mu.$$

If θ_1 be the angle of incidence and θ_2 the angle of refraction,

$$\cos \theta_1 = n_1, \quad \text{and} \quad \cos \theta_2 = n_2,$$

$$\therefore \sin \theta_1 = \sqrt{l_1^2 + m_1^2}, \quad \sin \theta_2 = \sqrt{l_2^2 + m_2^2};$$

also $m_1 = \mu m_2$, and $l_1 = \mu l_2 + \mu \frac{v_2 \cos \phi}{c_2} - \frac{v_1 \cos \phi}{c_1}$,

$$\therefore l_1^2 + m_1^2 = \mu^2 [l_2^2 + m_2^2] + 2\mu l_2 \left(\mu \frac{v_2 \cos \phi}{c_2} - \frac{v_1 \cos \phi}{c_1} \right).$$

Hence $\sin \theta_1 = \mu \sin \theta_2$, if $\frac{\mu v_2}{c_2} = \frac{v_1}{c_1}$,
that is, if

$$\frac{\mu_2}{\mu_1} \cdot \frac{c_1}{c_2} = \frac{v_1}{v_2} = \frac{\kappa_1 v}{\kappa_2 v} = \frac{\kappa_1}{\kappa_2},$$

or if
$$\frac{\kappa_1}{\kappa_2} = \frac{\mu_2^2}{\mu_1^2}.$$

Thus, if c_1 be the velocity of light in any medium at rest in the æther, and if μ_1 be the absolute index of refraction of the medium, the sine law of refraction will always be satisfied if we assume that the velocity of light relative to the medium when moving with velocity v in the æther, is

$$c_1 - \frac{Av}{\mu_1^2},$$

where A is a constant which must be the same for all media.

Further, the condition that the incident ray, the refracted ray, and the normal shall lie in the same plane is

$$\frac{l_1}{l_2} = \frac{m_1}{m_2}.$$

Therefore

$$\frac{l_1 + \frac{v_1 \cos \phi}{c_1}}{l_2 + \frac{v_2 \cos \phi}{c_2}} = \frac{l_1}{l_2} = \frac{\frac{v_1 \cos \phi}{c_1}}{\frac{v_2 \cos \phi}{c_2}} = \frac{v_1}{v_2} \cdot \frac{c_2}{c_1} = \frac{c_1}{c_2},$$

or
$$\frac{\kappa_1}{\kappa_2} = \frac{c_1^2}{c_2^2} = \frac{\mu_2^2}{\mu_1^2},$$

the same condition as before.

Thus both laws of refraction are satisfied on the above assumption.

In the limiting case when the absolute index of refraction of the first medium is unity, the expression $c_1 - \frac{Av}{\mu_1^2}$ becomes $c - Av$, where c is the velocity of light in the æther, and v the velocity of the second medium. But the relative velocity must then be $c - v$. Thus $A = 1$, and hence the velocity of light relative to any medium moving with velocity v is $c_1 - \frac{v}{\mu_1^2}$, the actual velocity being $c_1 + v \left(1 - \frac{1}{\mu_1^2} \right)$, where c_1 is the velocity of light in the medium when $v = 0$, and μ_1 is the absolute index of refraction of the medium. The case of reflexion, being a particular case of refraction, is included in the above discussion. Refraction in crystalline media can be similarly treated.

XII. *The Fundamental Law for the true Photographic Rendering of Contrasts.* By F. F. RENWICK, A.C.G.I., F.I.C.*

THE paper by Prof. Porter and Dr. Slade bearing the above title, in the July number of the Philosophical Magazine (vol. xxxviii. p. 187, 1919), on a method of deriving the relations which must hold good between the "characteristic" curves of the negative and positive materials if exact reproduction of the tones of the original subject is to be obtained, has shown me that the more general method which I adopted in treating this part of my subject in the nineteenth Traill Taylor Memorial Lecture (Phot. Journal, vol. lvi. p. 222, 1916) is not self-evident, as I had supposed.

Inasmuch as my method, unlike theirs, is not restricted to exact nor even to proportionally correct reproduction, but can be employed with equal facility for any desired relation between the original and the final copy, it is probably worthy of record.

The relations between the incident light and the effects produced in the subsequent development process are usually represented by Hurter and Driffield's method of "characteristic curves," in which the abscissæ are values of $\log E$ (E , the exposure, being the product of intensity I and time t), while the opacity-logarithms to base 10 (generally

* Communicated by the Author.

called "densities") of the resulting photographic images are the ordinates.

Now since, in accordance with Beer's law, the density of a neutral-tinted grainless medium is proportional to its thickness or its pigment concentration per unit area, densities increase in simple arithmetical progression from the light to the dark end of an optical wedge. Moreover it is important to observe that the gradation of such an optical wedge may be expressed equally well either as a uniform *rise* in density per unit length or as a uniform *drop* in $\log I$ of the same amount, if uniform illumination of the wedge be assumed. Since a grainless optical wedge affords a very convenient means of impressing on a photographic material a known and continuous range of exposures, *changing in exactly the same manner as do the values of $\log E$ along the exposure axis of a "characteristic" curve*, it is evident that the abscissæ values of any characteristic curve may be regarded as the logarithms of the exposures given to the material by illumination received through an optical wedge, while the uniformly illuminated optical wedge thus becomes the subject whose photographic rendering is under discussion.

To every point on the exposure axis of the characteristic curve there will then correspond a known $\log E$ and a known density value, while a length between any two such values will represent a known density difference or contrast and an equal but opposite $\log E$ difference.

$$\text{For} \quad D_1 = \log \frac{I_0}{I_1}; \quad D_2 = \log \frac{I_0}{I_2};$$

$$\text{hence} \quad D_1 - D_2 = \log I_2 - \log I_1 \\ = \log E_2 - \log E_1,$$

where I_0 = incident light intensity, I_1 and I_2 the transmitted intensities, and D_1 and D_2 the corresponding density values at any two points.

Case 1.—In fig. 1 let the two continuous curves represent the characteristic curves found for the negative and positive materials to be used. It is desired to deduce from them the gradation curve of a positive print made under the same conditions (development etc.) as were employed when these curves were obtained.

Assume that it is intended just to preserve a pure white (or clear glass) under the greatest density in the negative; then, such an exposure must be given that the lower limit of the

characteristic curve (below B) of the positive material is employed to reproduce the tone corresponding to the point P of the original.

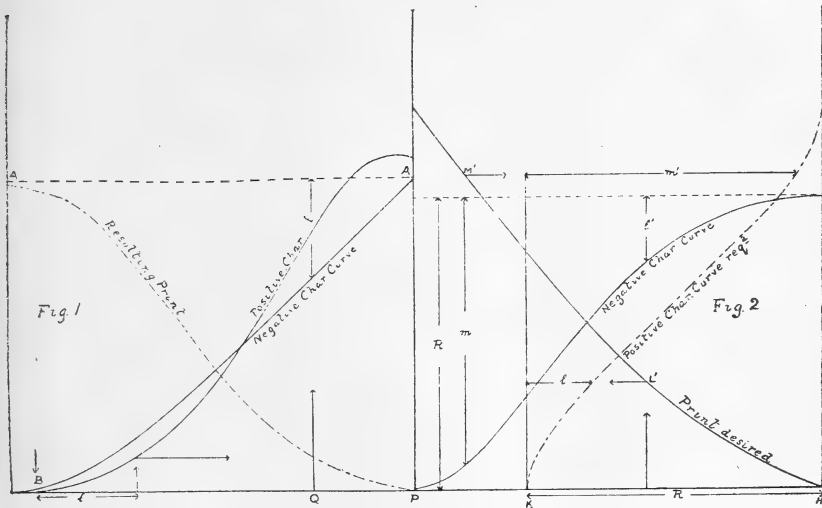

All other points on the required curve (dotted in the diagram, fig. 1) are now easily fixed in the following way:— Consider any point Q on the original wedge; the length l lying above this point between AA and the negative characteristic curve, represents the density difference, and therefore the $\log E$ difference, available for printing. Measure off l along the exposure axis from the starting point B; read off the density value on the positive characteristic curve above the point so found and transfer it as an ordinate to the point Q; and so on for as many points as desired.

Case II.—In fig. 2 let the continuous curves represent the characteristic curve of the negative material and the desired gradation of the finished print respectively. It is required to find what form of characteristic curve for the positive material would be necessary to obtain the desired result.

The total density range of the negative is represented by the height R on the ordinate scale; hence the total $\log E$ range of that part of the positive characteristic curve which concerns us is represented by an equal length on the exposure axis. For the sake of clearness this has been set off from the right side of the diagram as HK.

No density being required in the print where the least

exposure is given, the characteristic curve starts at K with zero density. All other points are easily deduced, as shown for L' and M', thus:—Since the lengths l' and m' represent density differences (and therefore $\log E$ differences) in the negative by means of which the densities L' and M' respectively are to be secured in the print, it is clear that the characteristic curve of the positive material must have density values equal to L' and M' at the $\log E$ values distant from K by the lengths l' and m' respectively.

It is, of course, equally easy to deduce a negative characteristic curve, given the positive characteristic curve and the final print.

It will be obvious that Porter and Slade's "conjugate" curves are simply a special case in which the gradation of the desired print is represented by a straight line rising at 45° ($\gamma=1$) from H.

Addendum.—I regret that in my remarks on Porter and Slade's paper, I neglected to state that the validity of the authors' neat proof of the necessary relations between positive and negative, if exact reproduction is required, is unaffected by the obscurities and omissions to which I desired to call attention. I have no desire to carry on a controversy concerning what are, after all, relatively minor points, and will therefore simply state my opinion that the authors themselves evidently regarded both I and E as intensities when writing their fundamental equation, $I=KE$, as is shown by the sentence near the bottom of p. 191:—"The more nearly K is to unity the more nearly will the light from the positive be not only the same in gradation as that from the subject but also the same in *absolute intensity*."

For those concerned with the practical application of such studies, their value would, I am sure, be much enhanced by a clearer statement of the meanings of the terms employed and by the exercise of a little more care when giving an outline of the current state of knowledge on the subject.

The power law attributed to me is not mine. I do not know its origin but, like many others, have simply accepted it as being, usually, the least objectionable departure from exact reproduction when the latter is impracticable.—
F. F. R.

XIII. *A Table of the Radioactive Elements which indicates their Structure.* By INGO W. D. HACKH, *Professor of Chemistry, College of Physicians and Surgeons of San Francisco, Cal., U.S.A.**

IN a recent paper on the "Conception of a Chemical Element as enlarged by the study of radioactive change," Prof. F. Soddy† has given a masterly summary of the present status of our knowledge concerning the radioactive elements. From a study of the phenomena of disintegration in connexion with the new periodic table‡, it becomes possible to ascribe a partial atom-structural formula to each of the radioactive elements§. Thus it has been shown that the emission of a helium particle (alpha-radiation) is accompanied by the shift of two "metastasic" electrons from the outer or valency ring into the next inner and unstable ring, while the emission of an electron (beta-radiation) is accompanied by the shift of one "metastasic" electron from the next inner and unstable ring to the outer or valency ring. In the calculation of the partial atom-structural formulæ the changes between the first and last member of each series have been utilised, for this difference furnishes a tangible basis of the structural composition of the respective atom.

Assuming that each transformation is caused by the emission of *one* helium particle resp. *one* electron from *one* atom, the atom-structural formula for uranium 1 is $u.\text{He}_8\text{E}_{8+6}$ and for thorium $t.\text{He}_6\text{E}_{8+4}$, while the last members of each series have a structure formula of $u.\text{E}_{4+4}$ for lead from uranium and $t.\text{E}_{4+4}$ for lead from thorium. The difference in the structure formulæ of the first and last members is therefore in the uranium series 8He and 6E, indicating eight alpha- and six beta-changes, while in the thorium series the difference is 6He and 4E, indicating six alpha- and four beta-changes.

The relationship among the members of the uranium-radium, uranium-actinium, and thorium series is shown in

* Communicated by the Author.

† Journ. Chem. Soc. cxv. p. 1 (1919).

‡ Journ. Am. Chem. Soc. xi. p. 1023 (1918); Am. Journ. Science, xlvi. p. 481 (1918); Astrophys. Journ. xviii. p. 241 (1918).

§ Phys. Rev. xiii. p. 165 (1919).

figure 1, in which the branching off of the actinium series is according to Soddy*. From the figure can be derived the partial structural formula of each of the radioactive isotopes. Thus the number of helium particles (and also the atomic

Fig. 1.

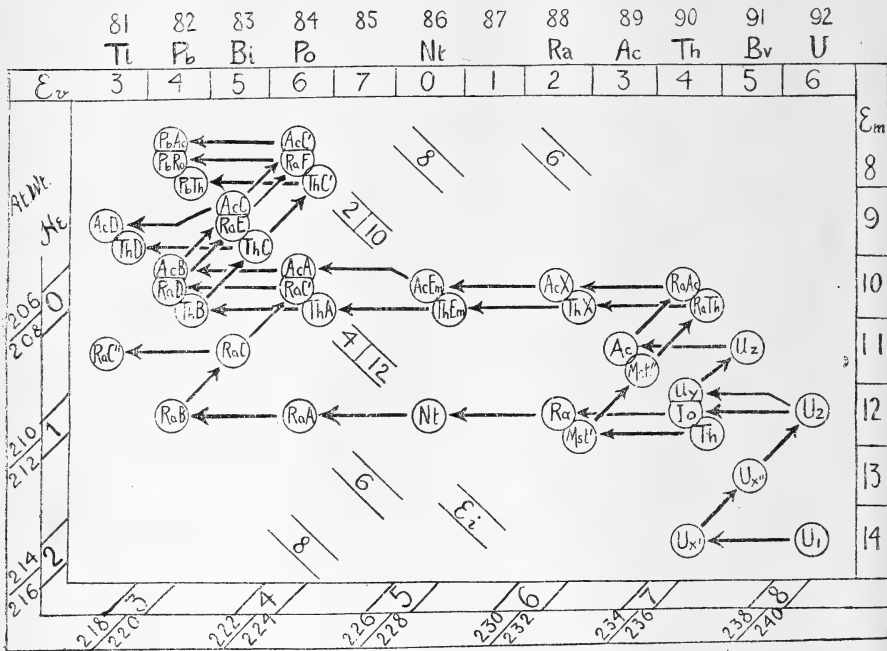

weight) is the same for each isotope lying on the same southwest to northeast axis; the number of electrons in the unstable next inner ring (E_i) is the same for each member on the same northwest to southeast axis; the number of valency electrons (E_v) are shown on the north to south axis, and the total "metastatic" electrons ($E_m = E_i + E_v$) are the same for each substance on the same east to west axis. In the partial atom-structural formula the nucleus u for uranium nucleus with atomic weight 206.4, and t for thorium nucleus of atomic weight 208.2, contains the unknown number of helium nuclei and electrons and indicates respectively lead from uranium and lead from thorium. To this nucleus are added the number of He, E_i ,

* *Loc. cit.*

and E_c , which constitute then the partial atom-structural formula. Thus *e. g.* the four isotopes of element with atomic number 88 are as follows :

AcX = u .	He ₄ E ₈₊₂	with an atomic weight of $u + 4\text{He} = 222.4$
ThX = t .	He ₄ E ₈₊₂	„ „ „ $t + 4\text{He} = 224.2$
Ra = u .	He ₅ E ₁₀₊₂	„ „ „ $u + 5\text{He} = 226.4$
Msth = t .	He ₅ E ₁₀₊₂	„ „ „ $t + 5\text{He} = 228.2$

As has been pointed out previously* this partial atom-structural formula indicates

- (a) the series to which the isotope belongs by u resp. t ;
- (b) the atomic weight, by the addition of the number of He (4.00) to u resp. t ;
- (c) the valency, by the number of valency electrons (E_v) written at the end ;
- (d) the number of metastasic electrons (E_m), by simply adding the inner and valency electrons together.

The relationship of this system of radioactive elements to the periodic system is established by attaching figure 1 to the lower part of the new periodic table †. Whether or not it is possible to extend this scheme of isotopes to the non-radioactive elements is a problem of the future.

Berkeley, Cal.,
July 26th, 1919.

XIV. *Note on the Construction of a Parabolic Trajectory and a Property of the Parabola used by Archimedes.* By W. B. MORTON and T. C. TOBIN ‡.

IF a particle is projected, in a given direction, from a given point A with such a velocity that it hits a second given point B, then any number of points on the path may be obtained by the simple construction shown in fig. 1. AH is drawn to any point on the vertical through B, HI is parallel to the direction of projection, then the vertical IP meets AH in a point of the path. This construction involves a simple property of the parabola which does not appear in the ordinary text-books. If chords are drawn

* Phys. Rev. *loc. cit.*

† *Loc. cit.*

‡ Communicated by the Authors.

from a point A on the curve to any other two points B, P, and if the diameters through B, P are drawn to intersect AP, AB respectively, then the line joining the points of intersection is parallel to the tangent at A.

Fig. 1.

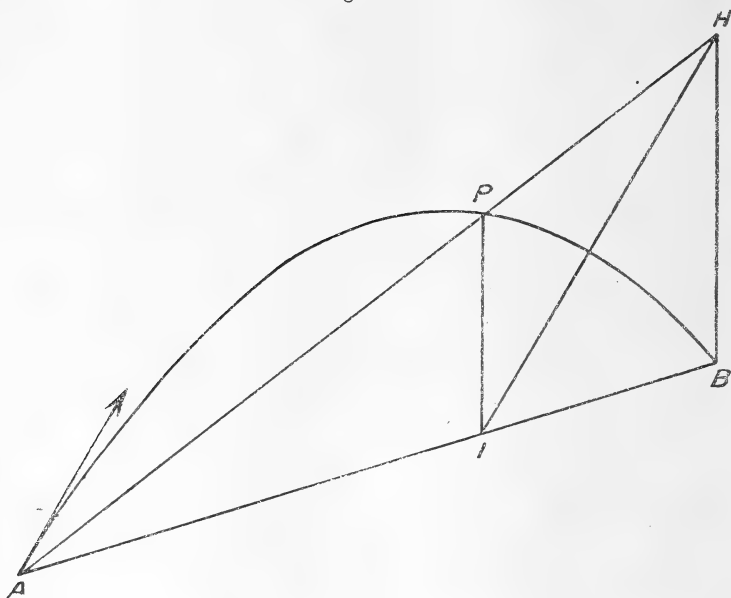

Referring to fig. 2 in which the parabola is placed in the more usual posture, assume that the points A, B and the tangent at A are given, and construct P in the manner indicated above. It can easily be shown that P lies on the curve.

For $AN : AK = PN : HK = PN : BM$
 and $AK : AM = IK : BM = PN : BM$
 $\therefore AN : AM = PN^2 : BM^2$.

It is interesting to notice that this property is really a special case of Pascal's theorem about a hexagon inscribed in a conic *. Let the angular points 1, 2, of the hexagon be at A, 3 at B, 4, 5 at the point at infinity on the axis of the parabola, and 6 at P. Then side 12 is the tangent at A, 23 is AB, 34 is BH, 45 is the line at infinity which touches

* This way of looking at the matter was pointed out to us by Mr. F. M. Saxelby.

buoyancy of the liquid, towards the position with axis vertical. In the course of the proof he quotes, as known, a property of the parabola which is an extension of that just obtained. The source from which Archimedes derived it is unknown.

Using the lettering of fig. 2, which agrees with that adopted in Heath's edition of Archimedes, the theorem in its most general form is as follows:—

From a point B on a parabola ordinates BM, BV are drawn to any two diameters AM, PV. Through any point K of AM a line is drawn, parallel to the ordinate BM, to meet PV in I. Then $PV : PI =$ or $> MK : KA$.

Archimedes refers only to the special case where A is the vertex of the parabola. A proof of this case, on somewhat algebraical lines, is given by Dr. Heath. The alternative geometrical proof now given exhibits, perhaps, in a clearer light the connexion of the theorem with the fundamental properties of the curve.

It has been shown above that the two ratios compared are equal when I is the intersection of AB with the diameter through P. It remains to prove the inequality in other cases.

Let K'I' be another position lying, say, to the left of KI, and let it meet AH in H'. Join MH' meeting UB in W', PW in W'', and BH in H''. We want to compare I'W'' with IW. We have

$$\begin{aligned} WW'' : HH'' &= AP : AH = AN : AK, \\ HH'' : HH' &= UM : UW' = AK : UW', \\ HH' : II' &= AP : AN = UW : AN. \end{aligned}$$

Compounding these ratios

$$\begin{aligned} WW'' : II' &= UW : UW', \\ \therefore WW'' &> II' \text{ and so } I'W'' < IW. \end{aligned}$$

If I'K' is taken to the right of IK it will be found in the same manner that $WW'' < II'$ and so I'W'' is again less than IW.

$$\therefore \text{ in every case } I'W'' : I'P < IW : I'P.$$

But $IW = PV$ and $I'W'' : I'P = MK' : K'A$,

$$\therefore MK' : K'A < PV : PI'.$$

THE
LONDON, EDINBURGH, AND DUBLIN
PHILOSOPHICAL MAGAZINE
AND
JOURNAL OF SCIENCE.

[SIXTH SERIES.]

FEBRUARY 1920.

XV. *The recent Eclipse Results and Stokes-Planck's Æther.*
By L. SILBERSTEIN, Ph.D., Lecturer in Mathem. Physics
at the University of Rome*.

1. IT is well known that, in 1845, Stokes proposed a theory of aberration (Phil. Mag. xxvii. p. 9), which was based on the assumption that the luminiferous æther surrounding our planet is dragged along in its annual motion so that the velocity of the æther relative to the Earth is nil at its surface, and, increasing continuously, becomes equal and opposite to the Earth's velocity at very large distances from the Earth or, to put it short, at infinity. The purpose of this hypothesis, as opposed to that of Fresnel's stagnant æther, was to give a *rigorous independence* of all purely terrestrial optical experiments *from the Earth's annual motion* (combined with that of the solar system). In order to account for the semi-terrestrial phenomenon known as astronomical aberration, Stokes had to assume that the motion of the æther, between the Earth and the stars in question, is purely *irrotational*. But, by a well-known theorem of hydrodynamics, this assumption was not compatible with the *incompressibility* of Stokes's æther and, at the same time, with the absence of slipping over the Earth's surface.

2. In order to overcome this essential difficulty Max Planck has suggested that the incompressibility could be

* Communicated by Sir Oliver Lodge.

given up* and replaced by the assumption that the æther is condensed round the Earth, and other celestial bodies, as if it were subjected to the force of gravitation and behaved more or less like a perfect gas. Lorentz, in spite of his personal preference for a fixed æther, took up Planck's idea and worked out the problem under the special (but by no means the only possible) assumption that the æther density ρ and pressure p obey Boyle's law, $\rho = \alpha p$, where $\alpha = \text{const.}$ If M be the Earth's mass, in astronomical units, this gives

$$\rho = \rho_\infty e^{\alpha M/r}, \dots \dots \dots (1)$$

where ρ_∞ is the density at infinity and r the distance of any external point from the Earth's centre. The maximum velocity of slip at the Earth's surface ($r=R$), in the direction opposite to that of its motion becomes †

$$v = \frac{v_\infty}{4} \cdot \frac{\sigma^3}{e^\sigma - (1 + \sigma + \frac{1}{2}\sigma^2)}, \dots \dots \dots (2)$$

where $\sigma = \alpha M/R$, and v_∞ is the velocity of the æther, relative to the Earth, at infinity.

To account for the astronomical aberration within the limits of experimental error it is necessary and sufficient to make $v = \frac{1}{100} v_\infty$. This gives, by (2), with sufficient approximation (since the required σ is manifestly so large as to make the second term of the denominator negligible),

$$\sigma^3 \doteq 0.04 e^\sigma,$$

so that the said requirement is amply satisfied by

$$\sigma = 10.2. \dots \dots \dots (E)$$

This means, according to (1), a condensation ‡ of the æther amounting at the Earth's surface to little less than

$$s \equiv \frac{\rho}{\rho_\infty} = 27000,$$

and gives at the same time for the (lower limit of the) coefficient α the value $10.2R/M$, to which we may return

* Cf. H. A. Lorentz's paper on Stokes's theory of aberration in *Amsterdam Proc.* for 1898-99, p. 443, reprinted in vol. i. of his *Abhandlungen*.

† A short deduction of this formula will be found in Lorentz's 'Theory of Electrons,' 1909, p. 314.

‡ What is commonly called "condensation" would in our case be $\frac{\rho}{\rho_\infty} - 1$. But it will be convenient to use this as a short name for ρ/ρ_∞ , which will henceforth be denoted by s .

later on. In order to reduce the slip to $\frac{1}{2}$ per cent. of v_{∞} a condensation of about 60000 would be required*.

In view of this considerable condensation, required by the theory of Stokes-Planck, Lorentz made in 1909 ('Theory of Electrons,' pp. 173-4) the following characteristic remark:—

"In this department of physics, in which we can make no progress without some hypothesis that looks somewhat startling at first sight, we must be careful not rashly to reject a new idea, and in making his suggestion Planck has certainly done a good thing. Yet I dare say that this assumption of an enormously condensed ether, *combined, as it must be, with the hypothesis that the velocity of light is not in the least altered by it, is not very satisfactory.*" [The last words are italicised for our present purpose.]

In fact, such a condensation, introduced *ad hoc* and serving only the negative purpose of not upsetting the theory of aberration, did not seem very satisfactory, and the present writer has as recently as 1914 expressed the same opinion in his book on Relativity (p. 63), not so much to defend Fresnel's and Lorentz's fixed æther, as to prepare the reader's mind for the complete abolition of the æther and thus to introduce him to Einstein's "special" relativity of 1905. Such has been the position of things until recently.

3. Now, it so happens that, stimulated by the desire to test Einstein's generalized relativity and theory of gravitation, the astronomers participating in the last Eclipse Expedition have found an undoubtedly positive effect, the bending of rays passing near the Sun. As I have pointed out on previous occasions, it seems premature to interpret this result as a verification of Einstein's theory, not merely in view of the small outstanding discrepancies, but chiefly in view of the failure of detecting the spectrum shift predicted by the theory, with which the whole theory stands or falls. But the Eclipse result proves at any rate that there is an "alteration," a change of light-velocity all around the Sun, which thus invalidates the words of Lorentz italicized in the quotation above. The condensation claimed by Planck's modification of Stokes's theory, for the Sun as well as for the Earth and for all other material bodies, is no longer devoid of influence on observable phenomena. It suddenly acquires physical life, so to speak.

* Notice that the aberration is a first order effect, while such phenomena as that expected by Michelson-Morley are second order effects (v^2/c^2), so that the above condensation suiting the aberration up to 1 per cent. will reduce the Michelson-Morley effect to one ten-thousandth of its value, and thus practically annihilate it. There is thus no need for making σ larger than 10·2.

In other words, the discovery made at Brazil naturally suggests the idea that the observed deflexion *is due to the condensation of the æther* around the Sun*, and although one has been an implacable enemy of any æther at all, for the last fifteen years, one does not hesitate to point out this possibility—a last glimpse of hope, perhaps, for the banished medium.

Let us imagine for the moment that Einstein had never published his debatable, though undoubtedly beautiful, new theory—not even that of 1905. Then it is almost certain that the Eclipse result would readily be acclaimed as an evidence of the condensation of the æther near the Sun, as required by the theory of Stokes-Planck, and would encourage the physicists to work out in detail the optical and associated consequences of such a condensation. But even though Einstein's theory has been published, and is being made popular in a most sensational way, we cannot help clinging to the said idea. I just learn from 'The Observatory' for August that Mr. Jonckheere suggested some months ago that refractions may, *inter alia*, be caused by "a hypothetical condensation of ether near the Sun." My point, however, is that such a source of refraction acquires a particular interest *if it is treated in connexion with the half-forgotten theory of Stokes-Planck*, when it ceases to be a detached hypothesis.

It is in this sense and in such an organic connexion that I should like to draw attention to this aspect of the subject.

Of course, the quantitative details of the suitable modification of the optical, or the electromagnetic, properties of the æther due to a radially symmetrical or any other condensation have to be worked out carefully. It is not the purpose of this Note to give a complete investigation of this kind, but only some hints at its possibility. Such hints, together with some remarks on the possible advantages of the advocated theory, will occupy our attention in the following sections.

4. If, merely to fix the ideas, the Boyle law is still adhered to, the condensation $s = \rho/\rho_\infty$ outside a radially symmetrical gravitating mass is given, as in (1), by

$$\log s = \frac{\alpha M}{r} (3)$$

If we assume, for places near the Earth's surface, not more and not less than what is just needed for the theory of

* The logarithm of this condensation would amount, at the Sun's surface, by (1) and (E), to the enormous figure $\sigma = \log s \doteq 31100$. (cf. the following footnote.)

aberration, *i. e.* $\sigma = \log s = 10.2$, we shall have at the surface of the Sun, as already mentioned in a footnote,

$$\sigma = \log s = 10.2 \frac{12.8}{42} 10^4 \doteq 31000, \dots \dots \dots (S)$$

which means, no doubt, an enormous condensation*. The corresponding relative velocity of slipping v/v_∞ will, by (2), be almost evanescent; the drag will be almost complete.

On the other hand, at the surface of a hydrogen atom, assumed for the moment to be a homogeneous sphere (and the only existing body), we shall have $\log s = 1.7 \cdot 10^{-34}$, that is to say,

$$s = \frac{\rho}{\rho_\infty} \doteq 1 + 1.7 \cdot 10^{-34},$$

indistinguishable from unity. Notice that for small σ the denominator in (2) reduces to $\frac{1}{6}\sigma^3 + \frac{1}{24}\sigma^4 +$ higher terms, so that the relative slip becomes

$$\frac{v}{v_\infty} \doteq \frac{3}{2} (1 - \frac{1}{4}\sigma) \dots \dots \dots (4)$$

For such bodies, therefore, as a hydrogen atom, or in fact any other atom, the ratio in question will be exceedingly nearly equal its limiting value $3/2$, which is well known to be the maximum relative slipping for a sphere moving in an incompressible liquid. In short, for such small bodies there will be practically no drag at all. The more so for electrons, if one wished to attribute to them gravitational properties. This behaviour will be important in connexion with some such electrodynamic theories of ponderable media, as is that proposed by Lorentz, which require a complete slip. But even a sphere of the mass of 1 kg. and the radius of 10 cm., for which $\sigma = 1.09 \cdot 10^{-16}$, will practically have no "grip upon the æther." This will readily be seen to account, among other things, for the negative results of Sir Oliver Lodge's ingenious experiments with the Ether machine, even if its whirling part were made much more massive. As a mere curiosity notice that even the Moon would have only a partial, weak grip upon our rehabilitated æther. In fact, at the Moon's surface we should have $\sigma = 10.2 \times 0.094 = 0.96$, and therefore, by (2), $\frac{v}{v_\infty} = 1.15$, which differs only by 0.35 from the full slip. Thus the Selenites would obtain with a

* Such fantastically large condensations need not frighten us. They can be reduced if Boyle's law is replaced by some other appropriate form of relation between pressure and density. Boyle's law, which is by no means necessary, is here used only, as the simplest one, for the sake of illustration.

Michelson-Morley experiment a pronounced positive effect. But enough has now been said in illustration of the formulæ for the condensation and for the slip.

5. Before passing to consider the Eclipse result it may be well to generalize the condensation formula (3) for the case in which Boyle's law is replaced by any relation between the pressure and the density of the æther. The corresponding generalization of the slip-formula (2), not required for our present purposes, may be postponed to a later opportunity.

Let the pressure p be any function of the density ρ alone, and let there be any distribution of gravitating masses. Introduce the function, familiar from hydrodynamics,

$$\Phi = \Phi(\rho) = \int \frac{dp}{\rho} \dots \dots \dots (5)$$

Then, in the state of equilibrium, and with dm written for any mass-element in astronomical units,

$$\Phi = \int \frac{dm}{r}, \dots \dots \dots (6)$$

where r is the distance of the contemplated point from dm , and the integral, representing the total gravitational potential, extends over all material bodies. Φ being a known function of ρ , formula (6) gives the required relation. It will be seen from the definition (5) that the dimensions of Φ (work per unit mass of æther) are those of a squared velocity. In order to bring this into evidence, let us recall that

$$v = \sqrt{\frac{dp}{d\rho}} \dots \dots \dots (7)$$

is the velocity of propagation of longitudinal waves in any compressible non-viscous fluid*. This velocity is, in general, a function of ρ , and becomes a constant for the special case of Boyle's law, namely, our previous $1/\sqrt{\alpha}$. Using (7) and writing, as before, $\frac{dp}{\rho} = d \log s$, we have

$$\Phi = \int v^2 \cdot d \log s, \dots \dots \dots (5a)$$

the required form. The integral is to be extended from

* This result, known as the formula of Laplace, holds also for the most characteristic kind of waves—to wit, for a wave of longitudinal discontinuity (Hugoniot, Hadamard), for which it follows directly, without integration, from the hydrodynamical equations of motion. See, for instance, my 'Vectorial Mechanics,' p. 169.

$s = 1$ (or $\log s = 0$) to the actual value of the condensation. Thus the condensation formula (6) becomes

$$\int v^2 \cdot d \log s = \Omega, \quad \dots \dots \dots (8)$$

where Ω has been written for the total gravitational potential at the place under consideration. For constant v (Boyle's law), and for a single spherical body, the previous formula (3) reappears.

It will be kept in mind that although the æther is assumed to behave in this way (say, like a gas) with respect to slow processes, it can still propagate rapid transversal light-disturbances as if it were an elastic solid (like the famous cobbler's wax of Lord Kelvin); but it will be best to think of light as of electromagnetic disturbances. The normal velocity c of propagating them is another property of the æther, independent of that which is represented by v , and subjected only to slight variations with condensation, as will appear presently. The ratio of v to c will be of importance, but as to the longitudinal waves themselves, they are of no physical interest for the present and, on the other hand, are not likely to become a nuisance. For it is not in our power to produce them to any relevant extent, and even if they are generated and maintained by some gigantic natural processes, their only effect would be to alter very slightly, here and there, the normal velocity of light-propagation.

If we wish to form an idea of the numerical value of v , or at least of its upper limit, for the case of Boyle's law, say, it is enough to take the value of σ given above for the Sun, and to remember that $M/c^2 = 1.5$ km., and, in round figures, $R = 7 \cdot 10^5$ km. Then the result will be $\frac{v}{c} = 8.2 \cdot 10^{-6}$, that is to say, v equal to about 2.5 km. per second*. This is quoted by the way only. But the ratio of these two velocities will be seen to acquire a particular interest in connexion with the recent astronomical discovery.

6. Let c , as before, stand for the propagation velocity of light in uncondensed æther, *i. e.* in absence of, or far away from, gravitating masses, and let c' be the light velocity at a place where the æther has undergone a condensation s . The question is: How are we to correlate c' with s ? In other words: On what are we to base the optical behaviour of the æther modified by a condensation? The only reasonable

* If so, then the condensational disturbances due to the Earth and other planets, whose velocities exceed v , will be confined to conical regions as in Mach's famous experiments.

answer is: On experience. For, clearly, we cannot deduce a relation, which is essentially electro-mechanical, from mechanical principles alone, or from electromagnetism alone. Nor can we imitate the usual dispersion theory (which makes use of both kinds of principles), for we are interested in those portions of the æther in which there are no atoms and no electrons.

In short, as was announced in section 3, let us write down the required relation by utilizing the observational result obtained by the Eclipse Expedition. In other words, let us see what that relation must be like in order to give the observed effect.

Now, if we disregard the small discrepancies (which may be either due to accidental errors or, perhaps, due to a superposed slight ordinary refraction), the observed total deflexions of the rays passing near the Sun are represented by Einstein's formula (quite apart from his theory)

$$\Delta\theta = \frac{1}{r_0} \frac{4M}{c^2},$$

where r_0 is the minimum distance of the (undeflected) ray from the Sun's centre, and it can easily be shown that such will be the case* if the refractive index $n=c/c'$ at any distance $r > R$ from the Sun's centre be determined by

$$n^2 = 1 + \frac{4M}{c^2 r},$$

or, denoting the potential by Ω , and generalizing to any distribution of gravitational matter,

$$n^2 = 1 + \frac{4\Omega}{c^2} \dots \dots \dots (9)$$

[This, in fact, is the formula which would follow at once from Einstein's approximate line-element

$$ds^2 = c^2 dt^2 \left(1 - \frac{2\Omega}{c^2}\right) - (dx^2 + dy^2 + dz^2) \left(1 + \frac{2\Omega}{c^2}\right),$$

for a "static" field.]

In order to obtain the required relation, that is to say the assumption to be made on the optical behaviour of the condensed æther, it is enough to combine equation (9) with our last equation (8), which gives

$$n^2 - 1 = \frac{4}{c^2} \int v^2 \cdot d \log s \dots \dots \dots (10)$$

* Approximately, that is, for small $\Delta\theta$, and consequently for a refractive index but little differing from unity.

Such, then, would be the required refractivity of the condensed æther, obeying any law $p=f(\rho)$. In particular, if it obeys Boyle's law, we have

$$n^2 = 1 + 4 \frac{v^2}{c^2} \cdot \log s, \quad (10 a)$$

which is of a surprisingly simple form, and reads: $n^2 - 1$ equal to *four times the logarithm of condensation multiplied by the squared ratio of the two velocities of propagation characterizing the æther*.

Notwithstanding this temptingly simple form of the relation, I shall not try to "deduce" it from things more familiar. I prefer to regard it as an assumption, dictated by observation.

If the reader so desires, he can write $n^2 - 1 = 4w/c^2$, where w is the work, per unit mass of matter, done by the gravitational field in condensing the æther. The small fraction $n^2 - 1$ being known from the Eclipse results (for any r), the numerical value of this work is determined without any further assumptions. If we agree to the lowest estimate of $\log s$ at the Sun's surface, as required by the aberration theory, we can also evaluate separately the ratio v/c , as already mentioned. This, however, is only a secondary matter.

7. Some details and further implications of the Stokes-Planck æther theory, supplemented by assumption (10), must be postponed to a later opportunity. Here it will be enough to add only a few more general remarks. It will be kept in mind that the proposed theory would account not only for the observed astronomical aberration and for the older terrestrial optical nil-effects, but manifestly also for the nil-effect of the Michelson-Morley experiment. The bending of rays round the more massive celestial bodies would be only a by-product of the theory. Again, in view of the exceedingly small condensation of the æther round single atoms or corpuscles there will be no difficulty in working out a satisfactory electromagnetic theory of ponderable media. The proposed theory would also have the advantage of not predicting the obstinately absent gravitational shift of the spectrum lines. It might also react, in part at least, upon the 1905 relativity, depriving it of its indispensability in most cases, but by no means banishing it from the whole domain of physico-mathematical investigations. Finally, the just objections raised by the advocates of the *physical* principle of causality against the fixed and homogeneous æther of Fresnel-Lorentz would not apply to Stokes's modified æther. For this

latter would by no means be a mere framework of reference axes and, as such, illegitimately privileged. For in referring a class of phenomena to the æther here advocated we would ultimately refer them to assignable physical things, namely those most massive gigantic bodies which, so to speak, have the strongest grip upon that medium. It is, among other things, this latter remark that I hope to make particularly clear at an early opportunity.

London,
December 22, 1919.

XVI. *Note on a Possible Structure for the Ether.*

By SIR OLIVER LODGE*.

DR. SILBERSTEIN'S communication gives me an opportunity for calling attention to a paper of mine on many points in connexion with the ether which must surely be of interest even to those who are contemplating the abandonment of that medium. In that paper an estimate is made of ethereal density, and an attempt to measure experimentally its lower limit is described; there are also comments of interest from Sir Joseph Larmor and Sir J. J. Thomson. The paper is in the *Phil. Mag.* ser. 6, vol. xiii. pp. 488-506, and is of date April 1907; though among other things it relates experiments conducted in and about 1893.

The transmission of transverse vibrations like light shows that the ether cannot be a mere structureless fluid; and if it is to be treated dynamically, which at first is surely a legitimate attempt, it must have properties akin to what we call, in matter, Rigidity and Inertia. Its inertia must be something fundamental, which underlies and accounts for the inertia we perceive in matter, possibly in a way having some analogy with a motion of a solid through a perfect fluid. For when an electric charge is moved, a magnetic field in the shape of an ether vortex-ring is generated (with an energy of circulation per unit volume equal to $\mu(ev \sin \theta)^2/8\pi r^4$), and this confers upon the charge its observed momentum if the medium has the requisite density (see *Phil. Mag.*, April 1907, vol. xiii. p. 492). The rigidity may be explicable hydrodynamically by a vortex circulation—a turbulent motion having a circulatory velocity of the same order as that of the waves which the medium is able to transmit.

In Lord Kelvin's laminar vortex arrangement the velocity

* Communicated by the Author.

of wave-propagation comes out $\frac{1}{3}\sqrt{2}$ or .47 of the average velocity of turbulent motion (see Phil. Mag. for October 1887, p. 350). In all investigations the two velocities come out of the same order: and in FitzGerald's collected papers, No. 53 and No. 91, the two velocities can be identical for a certain arrangement of turbulence (*cf.* pp. 259 & 256). On page 457, FitzGerald expresses his tentative opinion that the hypothesis that "the ether is a turbulent liquid has great possibilities underlying it." And, again, on p. 486, "there seems very little more besides interpretation of symbols to make a turbulent liquid a satisfactory explanation of the structure of the ether." Some assurance of stability may also be needed.

Many things show that any granular structure which may thus be possessed by the ether must be of a fineness incomparably minuter than any dimension associated with the material units on which we can experiment. In fact, the ether may quite well contain a linear dimension of the order 10^{-30} or 10^{-33} centim., and an energy of 10^{30} or 10^{33} ergs per cubic centimetre (Phil. Mag., April 1907, p. 493). The calm self-sufficient way in which it sustains all our stresses, and transmits all our energies, shows that anything we can impose upon ether is as far from perturbing it, or calling out even second orders of small quantities, as the slight bias of an ordinary draught of air is from perturbing the normal motion of the molecules which compose it. A bullet in air and an electron in ether can, however, attain perturbing velocities; and the fact is bound to be instructive when increase of mass with speed is fully assimilated and its mechanism understood. As said on p. 490 of the Phil. Mag. for April 1907, retaining the meaning but slightly improving the wording: The reason for the concentration of magnetic intensity at the equator of an electron, moving with something approaching the velocity of light, is that the flow associated with and indeed constituting the magnetic field is then no longer a small fraction of the intrinsic rotational velocity of the ether itself (see also *loc. cit.* p. 494).

To explain gravitational and other facts, we must assume that the very formation or existence of an electron sets up a radial strain or tension all round it, varying as the inverse distance, and likewise reduces the circulatory energy in its immediate neighbourhood; not necessarily causing any change of density, since electrostatic facts (notably the Cavendish experiment) show the ether to be practically, and probably actually, incompressible, but affecting its elastic or dielectric constant in such a way as to modify the velocity

of light in the neighbourhood. (Compare Lord Kelvin, Baltimore Lectures, p. 465.) An electron might, in fact, be a small region in which intrinsic circulation has ceased, so that it possessed inertia only.

The tension or reduction of pressure set up in the neighbourhood of such a centre of force could explain gravitational attraction, and a change of rigidity would also suffice to explain the very minute reduction in the velocity of light. The refractive index needed at any point is $1 + 2\gamma M/rc^2$, or $1 + u^2/c^2$, where u is the velocity of free fall from infinity, which is just what the light has done. The dielectric constant would be modified so that $K/K_\infty = 1 + 4\gamma M/rc^2$; the second term being Einstein's deflexion. It may be taken as representing the deficiency of ethereal circulation-energy near a massive body, as compared with the unmodified circulation-energy in free space. Just outside an electron this deficiency is of the order 10^{-42} ; though just outside the Sun it is of the order 10^{-5} .

This note is hardly germane to Dr. Silberstein's paper; so I may just add that the complication of introducing compressibility, and not only compressibility but an enormous gravitational compression, in order to evade rotationality in a hypothetical ether dragged by moving masses—for absence of velocity-potential is well known to complicate unduly the theory of astronomical aberration—does not commend itself to me. An incompressible ether, not viscous at all, is far more simple; and astronomical aberration then follows, as easily as on the corpuscular theory, without any ingenuity.

But, as speculation in these unconquered regions is a legitimate preliminary to exploration, I may say that I am fully prepared, as Dr. Silberstein in one part of his paper seems also prepared, to accept a gravitational influence on the Ether's dielectric constant, and, therefore, on the square of its index of refraction: though I should like to see this done without postulating any increase of density in a medium of which space is already completely full. It is also highly desirable to avoid the frictional and thermal considerations, accompanied by dissipation of energy, inseparable from any sort of viscosity. These imperfections are appropriate to a secondary or derived cosmic ingredient, like matter; they are not appropriate to the fundamental substance itself.

If the ether has demonstrated anything, so far, it has shown us, by its very elusive character and complete

transparency, that its properties are of the simplest and most uniform kind, and free from any imperfections which would accumulate waste energy in particular fractions of itself. If we attribute all locomotion to matter in its most general sense, including electric charges; and all elasticity to ether, regarding the latter as the uniting and potentially strained medium responsible for every force which holds atoms together; we shall be on sound and simple lines. This is not to deny that potential energy may be susceptible of ultimate kinetic explanation, in terms of the postulated fine-grained vorticity.

How the ether can be tied into the knots which we call electrons—in other words, how the peculiar regions or singular points characteristic of electric charge are constituted—remains to be discovered. The small second-order tension responsible for gravitation will, I feel sure, be accounted for as soon as the electric structure is made out. *The fact that a luminous disturbance simulates the fundamental properties of matter is giving us a broad hint.*

A wave-front is an evanescent kind of matter—a sort of attempt of an accelerated electron to reproduce itself: the question is how such a peculiarity, when generated, can be made permanent and its violent locomotion checked. We must find out how to disturb the ether in such a way that the modification shall remain concentrated, and not instantly rush away and disperse itself with the speed of light. The electric and the magnetic components must be separated, the one kept and the other annulled.

In this connexion, I take permission to make a few extracts from the 1907 edition of 'Modern Views of Electricity,' so as to bring the suggestions before those who may be interested in them. I quote from pages 330 onwards:—

"Wherever electrons and atoms exist, they modify the ether in their immediate neighbourhood, so that waves passing through a portion of space containing them are affected by their presence, as if the ether were more or less loaded by them; because the electric displacements which go on in the unseparated and still perfectly united constituents of free ether [in a beam of light] are also shared to some extent by the separated peculiarities All those charges which possess externally-reaching lines of force must share in the motion of the waves, without having the requisite amount of resilience to compensate for their inertia."

"The positive and negative constituents, when they combine or cohere, do not destroy each other and revert into plain ether again; on the contrary, they retain their individuality and persist, in either a combined or separate state. We do not know how to produce or to destroy these peculiarities [for whereas] matter can be

dissociated with extreme ease, the dissociation of ether is unknown and hypothetical, save as represented by its apparent results.

“Nevertheless, it must be the case that the slight, almost infinitesimal, shear, which goes on in a light wave, is of the nature of incipient and temporary electrical separation It appears possible that a sufficiently violent E.M.F., applied to the ether by some method unknown to us at present, must be the kind of influence necessary to shear it beyond the critical value and leave its components permanently distinct; such constituents being opposite electric charges, which, when once thoroughly separated, only combine to form matter, and do not recoil into ordinary ether again.”

Let me make one more quotation, immediately following, relating to gravitation:—

“Every attempt at separation of this kind, even if no stronger than exists in ordinary light, [is] accompanied by a longitudinal force—Maxwell’s pressure If the disturbance could be made so extreme as to result in permanent dislocation, this pressure might leave behind it, as permanent residue, a longitudinal pressure [or tension] extending throughout space.”

There seems to be a necessary connexion between transverse and longitudinal stresses, the one being $\frac{1}{2}u/v$ times the other. If we re-estimate Maxwell’s data for luminous vibrations, as given in his article “Ether” in the *Ency. Brit.* (Collected Works, vol. 2, p. 767), on the basis of a reasoned high estimate of ether density, ignoring the guess of that period that in the brightness near the Sun the amplitude of a light vibration might possibly be as great as one-hundredth of a wavelength, for this was only an upper limit and it is surely bound to be much smaller, we can proceed thus:—

Let a be the maximum amplitude of shear of a light wave, $y = a \cos p(x - vt)$, near the Sun; where the luminous energy is nearly 2 ergs per c.c.; and let u be the maximum speed of elastic recovery;

$$\text{then } \frac{u}{v} = \rho a = 2\pi \frac{a}{\lambda}.$$

The energy $\frac{1}{2}\rho u^2 = 2$ ergs per c.c.,

so, if $\rho = 10^{12}$, $u = 2 \times 10^{-6}$ cm. per sec., and $a = 10^{-17}\lambda$.

Hence, expressing conditions near the sun in Maxwell’s manner (*loc. cit.*),

Energy per cubic centimetre	$= \frac{1}{2}\rho v^2 a^2 p^2 = 2$ ergs.
Greatest tangential stress per sq. cm.	$= \rho v^2 a p = 6 \times 10^{16}$ dynes.
Coefficient of rigidity of ether	$= \rho v^2 = 10^{33}$ c.g.s.
Density of ether	$= \rho = 10^{12}$ „

It will be observed that $\rho v^2 a p$ is the same as $\rho v u$, which is an expression for the travelling momentum of a light-beam.

XVII. *The Spheroidal Electron.*

By Prof. A. ANDERSON*.

ON the supposition that the shape of an electron in motion is a spheroid, the direction of motion being along the axis of symmetry, and the charge on the correlated electron being distributed on its surface as if it were a conductor at rest, the values of the momentum and energy in the æther can be calculated. The length of the semi-axis in the direction of motion is b , and that of the semi-axis at right angles to this is a : b is thus the contracted length, or the length of the semi-axis in the direction of motion after it has suffered the Lorentz-FitzGerald contraction. As usual, β denotes the quantity $\left(1 - \frac{v^2}{c^2}\right)^{-\frac{1}{2}}$, where v is the velocity of the electron and c the velocity of light.

The results are, if $\beta b > a$,

momentum

$$M = \frac{e^2 \beta v}{16\pi c^2 (\beta^2 b^2 - a^2)^{\frac{1}{2}}} \left[\frac{2\beta^2 b^2 - a^2}{\beta^2 b^2 - a^2} \cdot \log \frac{\beta b + (\beta^2 b^2 - a^2)^{\frac{1}{2}}}{\beta b - (\beta^2 b^2 - a^2)^{\frac{1}{2}}} - \frac{2\beta b}{(\beta^2 b^2 - a^2)^{\frac{1}{2}}} \right]$$

and energy

$$E = \frac{e^2}{32\pi\beta(\beta^2 b^2 - a^2)^{\frac{1}{2}}} \left[\left\{ \beta^2 \left(1 + \frac{v^2}{c^2}\right) \left(1 + \frac{\beta^2 b^2}{\beta^2 b^2 - a^2}\right) - \frac{a^2}{\beta^2 b^2 - a^2} \right\} \log \cdot \frac{\beta b + (\beta^2 b^2 - a^2)^{\frac{1}{2}}}{\beta b - (\beta^2 b^2 - a^2)^{\frac{1}{2}}} - \frac{4\beta b}{(\beta^2 b^2 - a^2)^{\frac{1}{2}}} (\beta^2 - 1) \right].$$

If $\beta b < a$,

$$M = \frac{e^2 \beta v}{8\pi c^2 (a^2 - \beta^2 b^2)^{\frac{1}{2}}} \left[\frac{\beta b}{(a^2 - \beta^2 b^2)^{\frac{1}{2}}} + \frac{a^2 - 2\beta^2 b^2}{a^2 - \beta^2 b^2} \tan^{-1} \frac{(a^2 - \beta^2 b^2)^{\frac{1}{2}}}{\beta b} \right],$$

and

$$E = \frac{e^2}{16\pi\beta(a^2 - \beta^2 b^2)^{\frac{1}{2}}} \left[\frac{\beta b}{(a^2 - \beta^2 b^2)^{\frac{1}{2}}} \left(\beta^2 \left(1 + \frac{v^2}{c^2}\right) - 1 \right) + \left\{ 1 + \frac{\beta^2 b^2}{a^2 - \beta^2 b^2} + \left(1 - \frac{\beta^2 b^2}{a^2 - \beta^2 b^2}\right) \beta^2 \left(1 + \frac{v^2}{c^2}\right) \right\} \tan^{-1} \frac{(a^2 - \beta^2 b^2)^{\frac{1}{2}}}{\beta b} \right].$$

* Communicated by the Author.

If $\beta b = a$, both expressions for M and both expressions for E lead to the same results :

$$M = \frac{e^2 \beta v}{6\pi a c^2}, \quad E = \frac{e^2 \beta}{8\pi a} \left(1 + \frac{1}{3} \frac{v^2}{c^2} \right).$$

This is the case of the Lorentz electron.

If we make $a = b$ only the first pair of expressions can be used as $\beta b > a$, and we obtain

$$M = \frac{e^2}{16\pi a c} \left[\frac{v^2 + c^2}{v^2} \log \frac{c+v}{c-v} - \frac{2c}{v} \right],$$

$$E = \frac{e^2}{8\pi a} \left(\frac{c}{v} \log \frac{c+v}{c-v} - 1 \right),$$

which are the momentum and energy associated with the Abraham electron. Both electrons are, therefore, particular cases of the general spheroidal electron.

The transverse mass is M/v , and well-known experiments have been made to determine e/m and v , or, which is equivalent, e/M and v . Thus it would, no doubt, be possible, though perhaps the mathematical work would be tedious, to determine the value of the ratio of b to a for which the theoretical value of e/M would agree most closely with the experimental results. A determination of this ratio would be of interest. We may, however, remark that if the ratio of b to a tends to zero, the corresponding value of M tends to

$$\frac{e^2 \beta v}{16ac^2};$$

that is, the æther momentum associated with an electron whose shape is a plane circular disk moving with uniform velocity in a direction perpendicular to its plane is equal to $\frac{3\pi}{8}$ times the momentum associated with the Lorentz electron moving with an equal velocity. The ratio of its transverse mass to its mass when $v=0$ is the same as for the Lorentz electron, and the experimental results could not decide between them. In the case of a very elongated prolate spheroid moving in the direction of its axis of symmetry, both the momentum and energy become very great.

XVIII. *The Adjustment of Observations. I.*By NORMAN CAMPBELL, *Sc.D.**

1. **F**OR more than fifty years the method of adjusting observations affected by experimental errors has always been that originally proposed by Gauss. The rules necessary for its application are embodied in the formalism of the "Method of Least Squares." Against the method and the rules by which it is applied two main objections have often been urged: it is said that the theory on which the rules are based is not true and that, even if it were true, the rules are not an accurate expression of it. No serious inquirer pretends nowadays that the method can be completely defended against these objections: its use is justified partly on the grounds of practical convenience and partly on the ground that any method not open to these objections would produce practically the same results. The second contention is probably valid, but it provides a justification for the use of the method only if the first is also valid, and if there is no method equally convenient which is not open to more serious theoretical objections. I believe that the first contention is not valid and that in some cases—and especially in those cases of most importance in physics—there is a method of adjusting observations which is at once more convenient in practice and more sound in theory. The object of this paper is to explain and support that view.

Perhaps I may be pardoned for insisting at the outset that my remarks deserve some attention. The theory of errors has great intrinsic interest, but it is not a matter to which physicists, even if they are in the habit of using it, generally pay much attention. Its later developments are extremely complex and highly technical, and most of us do not study carefully the memoirs dealing with it which appear from time to time in scientific journals. Those memoirs do not generally pretend to subvert the accepted rules for adjusting observations, but only to extend them to somewhat unusual examples or to provide additional support for them. But I do wish to subvert those rules: I contend that the Method of Least Squares is an intolerably cumbrous method for obtaining quite misleading results, that there is a method which is incomparably simpler and gives results which are not misleading, and that the only persons who have any adequate reason for continuing the

* Communicated by the Author.

use of the older method are the members of the National Union of Computers (if there is such a body) who might be thrown out of a job if the proposed method were adopted. Since the only justification for the older method which has so far stood the test of criticism is that it is practically convenient, I maintain that the mere proposal of a more convenient method throws the *onus probandi* on those who refuse to use it.

2. The three problems.

There are three sets of circumstances in which the need may arise for adjusting "inconsistent" observations.

(1) A number of measurements which do not agree completely are made directly on a single magnitude, for instance, the length of some definite rod or the time of some definite process. It is required to determine from them the "true value." The rule universally adopted is that the arithmetic mean of the measurements should be selected as the true value*. We shall see that its validity might be established directly by experiment. It is doubtful whether the necessary experiments have actually been performed, but I shall assume that the universal acceptance of the rule shows that no experiments conflicting with it have been made, and that, therefore, if it were suitably tested, it would be established directly.

The matter is exceedingly important because on the acceptance of this rule are based, either explicitly (as by Gauss) or implicitly, the rules for solving the two remaining problems. Any theory of error which is to lead to practical rules must assume that in this case some rule is known for determining the true value from the inconsistent observations. If we did not accept the arithmetic mean as the true value, we should have to accept some other mean if any progress was to be made.

(2) A number of measurements have been made on several magnitudes between which a relation is known. The arithmetic means of the measurements made on each magnitude do not obey this relation; consequently they cannot be the true values. It is required to adjust the observations so as to obtain true values which do obey the relation. For example, the magnitudes may be the three angles of a plane triangle: their sum must be 180° ;

* Some modification of this statement may be necessary if "systematic error" is suspected. Such error will be discussed in the sequel. I do not think it can arise if the conditions contemplated are fulfilled strictly, and the measurements are made directly on a perfectly defined system.

and yet it may be found that the arithmetic means of the measurements made on each angle do not add up to 180° .

This problem is of great importance in some of the practical applications of science, such as surveying. It is not of much importance in pure physics, for we very seldom require to know with great accuracy and certainty the value of any directly measured magnitude; it is derived magnitudes that are important*.

(3) Measurements have been made on many sets of magnitudes (x, y, z, \dots), which are known to be related by a numerical law of which the equation is $f(x, y, z, \dots, a, b, c, \dots) = 0$, the form of the function f being known, but not the values of the constants a, b, c, \dots . For example, measurements have been made of the activity of a pure radioactive substance (I) at various times (t). It is known that I and t are related by the equation $I = I_0 \cdot e^{-\lambda t}$. It is found that no values can be assigned to the constants which are such that all the measured sets actually satisfy the equation. It is required to determine those values of the constants which are to be regarded as the true values.

This third problem is of immense physical importance, and the solution of it is involved in almost every experimental research. It is often solved by graphical methods: numerical computation is used only when the number of constants is too great to be represented on a plane diagram, or when it appears that graphical methods do not utilize fully the accuracy of the observations. But it is desirable to discuss methods of computation applicable even to those cases where graphical methods can also be used; for it will be admitted that both methods should be founded on the same principles.

3. *The principle of solution.*

The accepted method of solving the second and third problems, which is embodied in the Method of Least Squares, depends on the assumption that the true values of the measured magnitudes in the second problem or of the constants in the third are those which make the sum of the squares of the residuals a minimum: the residuals are the differences between the measured magnitudes and those calculated from

* The reason is that pure science is not concerned with the investigation of the properties of individual objects, but only with the establishment of laws. A magnitude which is determined by a law, and therefore important for pure science, is always a derived magnitude.

The procedure is so obvious that it would be the first to occur to anyone to whom the problem was presented. It has doubtless not been adopted mainly because the alternative method of Least Squares was held to be the only one that is justifiable by the theory of errors. But this procedure can also be based on theory. When we select a group of the equations and add them to obtain a normal equation, we are assuming that this equation is absolutely correct, and that the sums of the measured magnitudes are the same as the sums of the true magnitudes to which those measured magnitudes approach. In other words we assume that, if we take the sum of a group of measured magnitudes, the errors of measurement cancel out; we assume that the sum of the errors in any group is zero. Now if the group is sufficiently large, this assumption will be true, even if we believe in the Gaussian law of errors, but it will also be true if we adopt any other reasonable law of errors; for it is an assumption more fundamental than those on which the Gaussian law is based that positive and negative errors are "equally probable." Accordingly, if the groups into which the equations are divided are sufficiently large, the assumption that their sum will be free from error is based on theory much more firmly than the assumption of the Gaussian law; for the first assumption is part of the second, and the part which is least dubitable. The only question which can arise is whether the assumption, and the procedure founded on it, is justifiable when the groups which are added are not very large. In a later part of this paper I shall argue that, even in this case, the procedure, though not capable of complete theoretical justification, has more theoretical justification than any other, and a great deal more than that of the Method of Least Squares.

The proposed procedure may, therefore, be called the Method of Zero Sum (Z.S.) in contradistinction to the Method of Least Squares (L.S.). But even if its theoretical basis is accepted, two further objections may be urged against it. The first arises in connexion with the second problem of the adjustment of observations. We have measured the three angles of a triangle and find that the measured values do not add up to 180° . The method of adjustment proposed is to choose true values such that the sum of the errors is zero. But it is at once apparent that it is impossible to choose such values which will at the same time add up to 180° ; for the sum of the true values must be the same as the sum of the measured magnitudes: in this example then the method will not work. I cannot

help thinking that it is the failure of the method in this important application which has prevented its serious consideration. I shall argue later that in this example the Gaussian method also will not work, and that its application in the ordinary manner leads to a result which is directly contradictory to the assumptions involved in it. The Gaussian method, like that of Z.S., involves the assumption that there is no systematic error, and in this case the assumption cannot be maintained. We must base our procedure on a theory which recognizes systematic error.

However, at present we are concerned only with the third problem, and in connexion with this an objection may be urged against the method of Z.S. It may be said—and of course the statement of fact cannot be disputed—that the result which will be obtained will depend on the manner in which the observational equations are grouped to obtain the normal equations: if one grouping is adopted, one set of values will be obtained; if another grouping is adopted, another: Z.S. does not, like L.S., lead to a unique solution. Herein lies, to my mind, one of the chief advantages of Z.S. For the apparent uniqueness of the solution by L.S. is altogether misleading. It is true that the introduction of “probable error” admits implicitly that solutions other than that given by the normal equations are admissible; but that admission is so important that it ought to be stated explicitly. When we discuss in detail the theory of the matter we shall see that there is not the slightest reason of any kind for selecting one of the admissible solutions rather than another. However, for the purposes of practical convenience, it is certainly desirable to have some standard method of selecting a single value to represent the observations, even if that which is selected is not really different in importance from many others, simply in order that no scope may be left for personal choice and that all persons who consider the same observations may arrive at the same single value for expressing them. But if it is admitted that the choice of that standard method is to a large extent arbitrary, there is no difficulty in devising one that is suitable.

Accordingly in the application of the method of Z.S. it is proposed that the groups should be selected in the following manner. There is always at least one of the measured magnitudes (x, y, z, \dots) which may be assumed to be free from error: let it be y . (This assumption is also involved in L.S.) The observational equations are to be

arranged in increasing (or decreasing) order of y . If there are N equations and n magnitudes (x, y, z, \dots), and if $N = pn + q$, where p, q are integers, then the first normal equation is to be formed by adding the first p equations in this order, the second by adding the second p equations, and so on until $n - q$ normal equations have been formed; the other q normal equations are to be formed by adding $p + 1$ observational equations taken in order in the same way*.

The basis of part of this rule is obvious. The method provides that the number of observational equations added to form a normal equation is (as nearly as possible) the same for each normal equation. Since the assumption underlying the method is only true if that number be large, it is desirable to prevent it being smaller than it need be in any one case; that result is obtained by making the number equal in each case. The basis of the remainder may be seen by considering the case when there are only two magnitudes, x, y . Then we are practically taking the mean of each of two halves of the observations and determining b and m from these two means. The determination might be made graphically: we might plot the points representing the two means and draw a straight line through them. It would then be obvious that the accuracy with which the straight line could be drawn would be greater the greater the distance between the two points. It is desirable therefore that the difference between the two means should be as great as possible: this condition is obtained by arranging the observations in the order proposed for the purpose of forming the normal equations; for one mean is that of all the smallest values of y and of all the smallest (or largest) values of x , whereas the other is that of all the largest values of y and all the largest (or smallest) values of x .

4. Errors.

It will be convenient also to express the matter analytically. The normal equations will be

$$\left. \begin{aligned} X_1 &= bY_1 + cZ_1 + \dots m, \\ X_2 &= bY_2 + cZ_2 + \dots m, \\ &\vdots \\ &\vdots \end{aligned} \right\} \dots \dots \dots (3)$$

* It may be observed that if q is not 0 the result obtained will be slightly different according as an increasing or decreasing order of y is adopted. But the differences arising from this latitude of choice are completely negligible.

where (X, Y, Z, ...) are the means * of a group of observed (x, y, z, ...).

The solution is

$$b = D_b/D; \quad C = D_c/D; \quad \dots; \quad m = D_m/D; \quad \dots \quad (4)$$

where

$$D_b = \begin{vmatrix} X_1 Z_1 \dots 1 \\ X_2 Z_2 \dots 1 \\ \vdots \\ \vdots \end{vmatrix}; \quad D_m = \begin{vmatrix} Y_1 Z_1 \dots X_1 \\ Y_2 Z_2 \dots X_2 \\ \vdots \\ \vdots \end{vmatrix}; \quad D = \begin{vmatrix} Y_1 Z_1 \dots 1 \\ Y_2 Z_2 \dots 1 \\ \vdots \\ \vdots \end{vmatrix}$$

Now suppose that only one of the measured magnitudes, *x*, is liable to error and that all the measurements on the others are absolutely correct. This assumption is practically true in a large number of important cases; it is moreover essentially involved in the method of L.S., so that we are not introducing any new error by adopting it. Then if *db, dc, ... dm* are the errors caused in the calculated values of *b, c, ... m*, by errors *dX₁, dX₂, ...* in *X₁, X₂, ...*

$$\left. \begin{aligned} db &= 1/D(dX_1 \cdot D_b^1 + dX_2 \cdot D_b^2 + \dots), \\ dm &= 1/D(dX_1 \cdot D_m^1 + dX_2 \cdot D_m^2 + \dots), \end{aligned} \right\} \dots \quad (5)$$

where *D_b^r* is the minor of *X_r* in *D_b*.

The mean error of L.S. (from which the probable error is calculated by multiplying by 0.6745) is the mean of all the errors which might be expected if the observations were repeated a large number of times and the quantities calculated from each set of observations. In deducing it, it is assumed that the mean square errors $\overline{dX_1^2}, \overline{dX_2^2}, \dots$ are all equal and that the mean product errors $\overline{dX_1}, \overline{dX_2}, \dots$ are all zero. Adopting this assumption, we find

$$\overline{db^2} = \overline{dX^2}/p_b; \quad \overline{dc^2} = \overline{dX^2}/p_c; \quad \dots; \quad \overline{dm^2} = \overline{dX^2}/p_m; \quad (4)$$

where

$$1/p_b = \frac{(D_b^1)^2 + (D_b^2)^2 + \dots}{D^2} \dots \dots \dots (5)$$

* Strictly speaking, they are the sums, not the means. If *q* is 0 they could be converted into means by dividing each of the equations by the same number *p*—without, of course, any effect on the result. If *q* is not 0 the results would be slightly different if some equations were divided by *p* and some by *p*+1, but again the effect of neglecting this difference is quite inappreciable. In practice the normal equations will always be sums, not means; but in discussing them generally it will be assumed that they are means, not sums: no appreciable error is thereby introduced.

In accordance with the usual terminology, we may call $\sqrt{\overline{dX^2}}$ the error of a single mean X , and p_b, p_c, \dots, p_m the weights of b, c, \dots, m . For a given accuracy of the observations, the calculated values of b, c, \dots, m will be the more accurate the greater the weight.

If there are only two magnitudes x, y and only two constants b, m we have

$$p_b = \frac{(Y_1 - Y_2)^2}{2}; \quad p_m = \frac{(Y_1 - Y_2)^2}{Y_1^2 - Y_2^2} \dots \quad (6)$$

If there are three magnitudes and three constants b, c, m we have

$$\left. \begin{aligned} p_b &= \frac{(Y_1 Z_2 - Z_1 Y_2 + Y_2 Z_3 - Z_2 Y_3 + Y_3 Z_1 - Z_3 Y_1)^2}{(Z_2 - Z_1)^2 + (Z_3 - Z_2)^2 + (Z_1 - Z_3)^2} \\ p_c &= \frac{(Y_1 Z_2 - Z_1 Y_2 + Y_2 Z_3 - Z_2 Y_3 + Y_3 Z_1 - Z_3 Y_1)^2}{(Y_2 - Y_1)^2 + (Y_3 - Y_2)^2 + (Y_1 - Y_3)^2}; \\ p_m &= \frac{(Y_1 Z_2 - Z_1 Y_2 + Y_2 Z_3 - Z_2 Y_3 + Y_3 Z_1 - Z_3 Y_1)^2}{(Y_1 Z_2 - Z_1 Y_2)^2 + (Y_2 Z_3 - Z_2 Y_3)^2 + (Y_3 Z_1 - Z_3 Y_1)^2} \end{aligned} \right\} \quad (7)$$

From (6) we reach again the conclusion that the calculated values will be made most accurate by making Y_1 and Y_2 as different as possible, which is effected by grouping the observations in the manner proposed. In (7) the matter is more complicated, and the most accurate way of grouping the observations depends on the values of b, c ; but in many important cases the rule which has been proposed gives the calculated values the greatest possible weight, and in no case does it seem to give them a weight very much less than the greatest possible. When ease of application is taken into account it is improbable that any more suitable rule of general validity could be found.

By the aid of (4) and (5) probable errors of the calculated values can be found in a manner exactly similar to that of the method of L.S. We shall inquire later what is the significance of such probable errors according to L.S. or Z.S., but for the present we shall use them merely as a rough method of comparing the results obtained by the two methods. It should be observed that when (4) is used in L.S. to obtain the probable error, $\overline{dx^2}$ occurs in place of $\overline{dX^2}$, where $\overline{dx^2}$ is the mean square error of a single observation and $\overline{dX^2}$ the mean square error of the arithmetic mean of p such single observations. In our estimates of probable error by Z.S.,

we shall assume the usual results of L.S., namely, that $\overline{dx^2} = \frac{\sum v^2}{N-n}$, where $\sum v^2$ is the sum of the squares of the residuals, and $\overline{dX^2} = \frac{d\overline{dx^2}}{p-1}$.

Examples.

It will now be well to show how the proposed method works out in practice. The chief difficulty is in the selection of material. I have a large amount of matter of my own to which it might be applied, but the use of that matter might not inspire confidence. Observations are not usually published in sufficient detail to enable them to be recalculated; so three examples have been taken (although they are not wholly suitable, because the number of observations are so small) from the 8th edition of Merriman's 'Method of Least Squares,' pp. 126, 132, 138. The advantages of the method in the saving of labour increase rapidly both with N and n , but even in these simple cases they are enormous. In L.S. $\frac{1}{2}Nn(n+1)$ multiplications have to be performed, and then $\frac{1}{2}(n+2)(n+1)$ columns, each of N entries, added; in Z.S. there is no multiplication, and only $N(n+1)/n$ columns, each of N/n entries, are added. Using a calculating machine, to which I am thoroughly accustomed, omitting all "checks" (and the omission wastes time on the whole), and reducing writing to a minimum by keeping figures on the board of the machine, I found that the mere writing, quite apart from calculation, involved in the formation of the normal equations of L.S., occupied longer than the complete formation of these equations by Z.S. The solution of the equations takes the same time in either case: it takes longer than the formation of the normal equations by Z.S., but not nearly as long as that by L.S.

In each example there is given (1) the equation which the observations have to satisfy; (2) the observations; (3) the normal equations and solution by L.S.; (4) the normal equations and solution by Z.S.; (5) in the last four columns of the observations, the residuals and their squares according to L.S. and Z.S. The observations which are added to give the normal equations of Z.S. are bracketed. In the third example the equation (1) is not linear: for the purposes of calculation it was reduced to linear form, in accordance with the usual practice, by taking logarithms of both sides; these logarithms, used in the calculation, are given in the table.

EXAMPLE 1.

$$x = by + m.$$

	x .	y .	L.S.		Z.S.	
			$v \times 10^3$.	$v^2 \times 10^8$.	$v \times 10^5$.	$v^2 \times 10^8$.
(1)	39.21469	0.9688402	+318	1011	+324	1050
(2)	39.20335	0.9289304	- 9	1	- 4	0
(3)	39.19519	0.8904120	- 49	24	- 42	18
(4)	39.17456	0.7929544	-281	790	-277	767
(5)	39.13929	0.6127966	- 26	7	- 23	5
(6)	39.10168	0.4254385	+ 1	0	+ 1	0
(7)	39.03510	0.0948286	+ 25	6	+ 23	5
(8)	39.02425	0.0505201	-164	269	-167	279
(9)	39.01884	0.0341473	-374	1399	-377	1421
(10)	39.01997	0.0218623	- 12	1	- 14	2
(11)	39.02410	0.0190338	+457	2088	+454	2061
(12)	39.01214	0.0019464	-393	1544	-396	1568
(13)	39.02074	0.0000515	+505	2550	+503	2530
			$\Sigma v_+ 1306$	$\Sigma v^2 9689$	$\Sigma v_+ 1305$	$\Sigma v^2 9706$
			$\Sigma v_- 1308$		$\Sigma v_- 1300$	

$$\begin{aligned} \text{(L.S.)} \quad 508.18390 &= 13.000000m + 4.848702b \\ 189.94441 &= 4.848702m + 3.804394b^* \end{aligned}$$

$$m = 39.01568 \pm 0.00077, \quad b = 0.20213 \pm 0.00142.$$

$$\begin{aligned} \text{(Z.S.)} \quad 274.06386 &= 7m & + 4.721201b \\ 234.12004 &= 6m & + 0.127501b \end{aligned}$$

$$m = 39.01571 \pm 0.00089, \quad b = 0.20204 \pm 0.00184.$$

$$\text{From eqns. (1-7)} \quad m = 39.01530 \quad b = 0.20265$$

$$,, \quad \text{(8-13)} \quad m = 38.9751 \quad b = 0.21118$$

† This equation is misprinted in Merriman.

In Examples 1 and 3 there is no material difference between the results obtained by the two methods; they agree well within the probable error. The probable error in Example 3 is actually less for the result by Z.S. than for that by L.S. Indeed in that example the comparison does not appear as favourable to Z.S. as it ought to be. For the residuals are calculated for $\log x$: strictly they should be calculated for x . If they are so calculated, Σv^2 is slightly less for the result by Z.S. than for that by L.S.: the Least Square method does not actually produce the least squares.

EXAMPLE 2.

$$x = by + cz + m.$$

	<i>x.</i>	<i>y.</i>	<i>z.</i>	L.S.		Z.S.	
				$v \times 10^4.$	$v^2 \times 10^8.$	$v \times 10^4.$	$v^2 \times 10^8.$
(1) }	3·1950	0	0	- 1	1	+25	625
(2) }	3·2299	0·1	0·01	-18	324	-14	196
(3) }	3·2532	0·2	0·04	+ 2	4	-11	121
(4) }	3·2611	0·3	0·09	+21	441	- 1	1
(5) }	3·2516	0·4	0·16	+19	361	- 6	36
(6) }	3·2282	0·5	0·25	+31	961	+ 8	64
(7) }	3·1807	0·6	0·36	-44	1936	-59	3481
(8) }	3·1266	0·7	0·49	-33	1089	-33	1089
(9) }	3·0594	0·8	0·64	0	0	+22	484
(10) }	2·9759	0·9	0·81	+24	576	+72	5184
				Σv_+ 97	Σv^2 5693	Σv_+ 127	Σv^2 11261
				Σv_- 96		Σv_- 129	

$$\begin{aligned} \text{(L.S.)} \quad 31\cdot761600 &= 10\cdot00m + 4\cdot500y + 2\cdot8500z \\ 14\cdot089570 &= 4\cdot50m + 2\cdot850y + 2\cdot0250z \\ 8\cdot828813 &= 2\cdot85m + 2\cdot025y + 1\cdot5333z \end{aligned}$$

$$m = 3\cdot1951 \pm 0\cdot0015, \quad b = 0\cdot4425 \pm 0\cdot0077, \quad c = -0\cdot7653 \pm 0\cdot0081.$$

$$\begin{aligned} \text{(Z.S.)} \quad 9\cdot6781 &= 3m + 0\cdot3y + 0\cdot05z \\ 9\cdot7409 &= 3m + 1\cdot2y + 0\cdot50z \\ 12\cdot3426 &= 4m + 3\cdot0y + 2\cdot30z \end{aligned}$$

$$m = 3\cdot1925 \pm 0\cdot0034, \quad b = 0\cdot4678 \pm 0\cdot0072, \quad c = -0\cdot7960 \pm 0\cdot0081.$$

$$\begin{aligned} \text{From eqns. (1-5),} \quad m &= 3\cdot21955, \quad b = 0\cdot3652, \quad c = -0\cdot7079. \\ \text{,, (6-10)} \quad m &= 3\cdot20265, \quad b = 0\cdot2670, \quad c = -0\cdot3065. \end{aligned}$$

This discrepancy is, of course, due to the fact that it is the sums of the squares of the residuals of $\log x$, and not of x , that have been made a minimum: this process, though almost always adopted, is not justifiable by the theory on which the method is based. On the other hand, it is legitimate to apply the method of Z.S. to the logarithms; for, so long as the errors are small, the solution which makes the sum of the errors of x zero will also make the sum of the errors of $f(x)$ zero, whatever may be the function f (so long as it has no singular points in the neighbourhood). Here is another advantage of the method of Z.S. It can be applied directly to an equation that is not linear, so long as that equation can be reduced to

EXAMPLE 3.

$$x = my^b.$$

	x .	y .	$\log x$.	$\log y$.	L.S.		Z.S.	
					$v \times 10^4$.	$v^2 \times 10^8$.	$v \times 10^4$.	$v^2 \times 10^8$.
(1)	1.731	0.1144	0.23830	-0.94157	+ 7	49	+ 9	81
(2)	1.853	0.1312	0.26788	-0.88207	-38	1444	-37	1369
(3)	1.984	0.1445	0.29754	-0.84013	+18	324	+19	361
(4)	2.081	0.1579	0.31827	-0.80162	+ 5	25	+ 5	25
(5)	2.171	0.1701	0.33666	-0.76930	+ 4	16	+ 3	9
(6)	2.258	0.1813	0.35372	-0.74160	+15	225	+15	225
(7)	2.326	0.1925	0.36661	-0.71557	- 5	25	- 6	36
(8)	2.397	0.2026	0.37967	-0.69336	- 1	1	- 2	4
(9)	2.460	0.2123	0.39094	-0.67305	- 5	25	- 7	49
					$\Sigma v_+ 49$	$\Sigma v^2 2134$	$\Sigma v_+ 51$	$\Sigma v^2 2150$
					$\Sigma v_- 49$		$\Sigma v_- 52$	

$$\begin{aligned} \text{(L.S.)} \quad 2.9496 &= 9.0000 \log m - 7.0583 b \\ -2.2758 &= -7.0583 \log m + 5.6008 b \\ \hline m &= 5.98 \pm 0.050, \quad b = 0.5727 \pm 0.0045. \end{aligned}$$

$$\begin{aligned} \text{(Z.S.)} \quad 1.45865 &= 5 \log m - 4.23471 b \\ 1.49094 &= 4 \log m - 2.82358 b \\ \hline m &= 6.00 \pm 0.025, \quad b = 0.5743 \pm 0.0023. \end{aligned}$$

$$\begin{aligned} \text{From eqns. (1-5)} \quad m &= 6.07, \quad b = 0.580. \\ \text{,, (6-9)} \quad m &= 5.73, \quad b = 0.546. \end{aligned}$$

the linear form by a change of variable; whereas strictly the method of L.S. ought not to be so applied. If the method of L.S. is adopted the process of successive approximation, which has to be used when the equation cannot be reduced to the linear form by change of variable, ought always to be applied to a non-linear equation, even when it can be so reduced.

On the other hand, in Example 2 there is a difference between the values of b and c deduced by the two methods which exceeds the probable error of either method. But an examination of the residuals at once shows the explanation. The equation to which the observations are to be fitted is empirical; the residuals show a systematic variation which indicates that the formula is not strictly true. At the bottom of the table are given the values of b , c , m calculated by L.S. first from the first 5 equations and

second from the last 5. The differences between the resulting values of b and c obtained from these two parts of the observations differ by far more than the probable error; this difference is an indication that the formula applicable to the observations with small values of y is not applicable to the observations with large values. It is not strictly legitimate to apply the same values of b, c, m to all the observations. And if it is not legitimate, of course the method of Z.S., which divides the observational material into two parts and assumes that the equation is equally true for all of them, will give a result different from that obtained by the method of L.S. which treats that material as a whole. If our object is merely to represent the observations as nearly as possible by a convenient empirical formula, it may certainly be better in such cases to employ the method of L.S.: a closer fit is likely to be obtained. But then the problem is not one of pure physics, which is not concerned at all with merely empirical formulæ; neither method of adjustment has in such cases any true validity at all, for the adjustment itself is fundamentally false. And if the object is merely to obtain an empirical formula it may be urged that, though L.S. gives a closer fit, it is scarcely worth obtaining at the expense of the enormously greater labour.

It may be noted that, for comparison, the observations of Examples 1 and 3 have been divided similarly into two parts, each of which is adjusted separately by L.S. The results are given at the foot of each table. It will be seen that in these examples, where the equations do fit the observations (although the equation of Example 3 is also empirical), there is very much less difference between the values given by the two parts of the observations. (The value of m for the second half of Example 1 is subject to a very large probable error, as may be seen by examining the observations on which it is based; the differences are not at all inconsistent with the applicability of the same constants to the whole of the observational material.)

5. *Some further considerations.*

These examples—and a great many others have been examined—show that the method proposed is perfectly practicable and that it does not lead to results differing very greatly from those of the method of L.S. And that proof, as I hold, throws the task of justifying their action on those who continue to employ a method which is admittedly invalid theoretically and exceedingly cumbrous in practice.

I maintain that, until it is shown to lead to misleading results, the method of Z.S. holds the field against any other, merely on the ground of simplicity. However, I am prepared to admit that in certain cases it loses much or all of its advantage, namely in those for which N is not very much greater than n , and the number of observations not much greater than the number of variables. It is then found—as might be expected from the fact that p is little if at all greater than 1—that values obtained for the constants vary greatly with the precise grouping of the observations in the formation of the normal equations, and the probable error of the result is much greater than can be judged significant according to the criterion which will be developed at a later stage. Of course the best method of dealing with such cases is to make more observations and so cause N to be much greater than n ; but if, for any reason, that course is impossible, and if some single value must be obtained, then it is probably better to employ L.S. unless N is at least as great as $3n$. But the use of that method is a mere matter of practical convenience: I deny altogether that, in general, the results obtained have any greater theoretical significance than the widely differing results obtained by the method of Z.S. There is simply no theoretical ground for any single value whatever within very wide limits.

These considerations have a bearing on the second problem of adjustment of observations, namely that in which it is required to determine true values of the measured magnitudes and not constants of an equation which they satisfy. The true values are now values such that they satisfy some equation of which the constants are definitely known. In one form of the problem, this equation contains, besides the variable magnitudes, a constant term to which a definite numerical value is assigned. An example of this form is the problem of the angles of a triangle, and we have already noted that the method of Z.S. (and that of L.S.) must fail when applied to that problem. But in a second form, the "equation of condition" does not contain a constant term, but relates only the measured variables. An example of this form is the problem of adjusting the results of a levelling survey: here it is known (*e. g.*) that the height of A above C must be the sum of the heights of A above B and of B above C, but there is no numerical constant known apart from the observations.

In this problem it is possible to find true values such that they satisfy the equation of condition and make the sum of the errors zero; and rules for applying the method of Z.S.

can easily be devised. But since the equations of conditions are never much more numerous than the observations (they are usually much less numerous), N is never large compared with n . Accordingly Z.S. gives results varying widely as different methods of grouping are adopted; and though there is no reason to believe that all these results are not admissible, it is difficult to fix precisely one method of grouping, so that the first requisite in problems of surveying, namely that a definitely unique set of values shall be obtained, is fulfilled. It is certainly better to adjust by the method of L.S. And it is fortunate here that the method loses most of its disadvantages. The coefficients of the equations of condition are usually small integers, so that the calculation is easy. Moreover it will appear in the sequel that this is the one form of problem to which L.S. is strictly applicable on theoretical grounds. It is here that there is most evidence that the Gaussian law of error is true, and here that the method is an adequate expression of the Gaussian theory. I believe indeed that the Gaussian method was originally elaborated to deal with just this problem: if so, it was completely justified. It is only its extension to the other form of the second problem (where there is a constant term in the equation of condition), and to the third problem, that is both theoretically illegitimate and practically inconvenient.

It is admitted then that, in this direction, room still remains for the method of L.S. This admission may seem to weaken somewhat the case for its replacement elsewhere by Z.S. Accordingly, before proceeding (in a subsequent paper) to a discussion of the validity of the two methods according to the theory of errors, it may be well to point out that there are examples to which L.S. is as clearly inapplicable as Z.S. is to that which has just been discussed. These examples occur when the equation (1) reduces to the simple form $x = by$, as happens when we have to determine a density (b) from measurements of a mass (x) and a volume (y).

An elementary student, when he had measured several sets of associated values of x and y , would doubtless take the ratio x/y in each set, and take for b the mean of these ratios. A more experienced worker would realize at once that such a procedure gives undue weight to the ratios derived from the smaller values of x, y , which are likely to be less (relatively) accurate. He would probably add all the x 's and all the y 's and take the ratio of the sums. This is exactly the procedure of the method of Z.S. But nobody, I believe, would adopt the

method of L.S., according to which $b = \frac{\sum x^2}{\sum xy}$. In this case actual practice would always follow Z.S. and not L.S.

And I do not think the reason is merely simplicity. This example calls attention to a fundamental ambiguity in L.S. If the relation between x and y were written $ax=y$, then L.S. indicates that $a = \frac{\sum y^2}{\sum xy}$. But then, in general, it would not be found that $a = 1/b$; in our example the specific volume would not be the reciprocal of the density. On the other hand, according to Z.S. that relation always would be fulfilled. It is probably the realization of this ambiguity which prevents anyone using L.S. in dealing with such observations.

But the ambiguity is not confined to this simple example. If, in place of

$$x = by + cz + \dots + m, \quad \dots \quad (8)$$

we write

$$ax = y + c'z + \dots + m', \quad \dots \quad (9)$$

we shall not find in general that $(a, c', \dots m') = (1, c, \dots m)/b$, if we calculate the constants by L.S. The reason is that the method of L.S. assumes that only one of x, y, z, \dots is affected by any error at all, and that this one is x , of which the constant coefficient is 1. We get different results by using (8) and (9) because in one case we are attributing the residuals to errors in x , in the other case to errors of y . It is generally recognized that L.S. is only applicable strictly when one variable alone is liable to error—though it is often applied when that condition is certainly not fulfilled. But it appears not to be recognized generally that, even when it is known that only one variable is liable to error, it is very seldom known which of the variables is this one. For instance, I am observing the position of a pointer at various instants of time. Are my errors due to observing the wrong position at the right time or observing the right position at the wrong time? Indeed is there any sense in asserting one of these statements rather than the other? But according as I adopt one statement or the other I shall obtain different values for the constants of the equation relating position and time, if I calculate according to the method of L.S.

This appears to me the most fundamental objection to L.S. as a means of obtaining unique values in the solution of problems of the third kind. It is important to realize that it does not arise in dealing with problems of the second kind. To ascertain how the ambiguity is introduced, we must

examine the method in further detail ; but since I do not wish to found my plea for Z.S. rather than L.S. on theoretical considerations, the examination will be left for a subsequent occasion. All that I am concerned to prove here is that Z.S. is much more convenient than L.S. in the problems which arise in physics, and that since L.S. is certainly not theoretically unobjectionable, there is nothing to outweigh its practical inconvenience.

Summary.

It is urged that, for the adjustment of observations in those problems which are of importance in physics, there is a method much simpler and more convenient practically than the conventional Method of Least Squares. This method, which is called that of Zero Sum, depends on the principle that the sum of a large random collection of errors is zero.

It is not maintained that the method of Z.S. is completely valid theoretically, but it is maintained that it is no less valid than the Method of Least Squares. Accordingly the burden of proof rests on those who continue to use a method which is neither practically convenient nor theoretically unobjectionable.

However, in a subsequent paper it will be maintained that the method of Z.S. has the advantage in theoretical validity as much as in practical convenience.

Research Laboratories of the
General Electric Co. Ltd.
Nov. 1919.

XIX. *The Buckling of Deep Beams.* (Second Paper.) By J. PRESCOTT, M.A., D.Sc., Lecturer in Mathematics in the Faculty of Technology of Manchester University ; with an Appendix by H. CARRINGTON, B.Sc., M.Sc.Tech., A.M.I.M.E.*

IN the first paper on this subject† it was shown that a deep beam may fail by a sort of torsional instability, and the particular load at which this instability occurs was calculated for beams under uniform loads or under concentrated loads with various methods of support. In this paper more general forms of the differential equations will be deduced than in the earlier paper, and some of the results will be extended. Moreover, the appendix contains a verification of one of the formulæ by means of experiments.

* Communicated by the Author.

† Phil. Mag. October 1918.

carried out in the Manchester College of Technology by Mr. H. Carrington.

The same notation as in the first paper will be used, and it will be useful to explain the notation again here —

- E = Young's modulus,
- EC = the flexural rigidity of the beam for horizontal bending,
- n = the modulus of rigidity,
- Kn = the torsional rigidity of the beam,
- τ = the angle of twist of the beam at any point D ,
- y = the deflexion of the central line of the beam from the naturally straight state at the same point,
- x = the abscissa of D referred to an x -axis taken along the unstrained central line of the beam.

The coordinate y is a horizontal one, the assumption being made that the depth of the beam is so much greater than the width that the vertical deflexion is negligible compared with the horizontal deflexion when buckling occurs. Moreover, the vertical plane containing the central line in the unstrained state is supposed to be a plane of symmetry of the beam.

In the first paper the differential equations for each beam were worked out separately. It will be shown here that they all come under one general form.

Suppose ODB is the plan of the central line of a uniform beam which is bent sideways as shown in fig. 8. At the

Fig. 8.

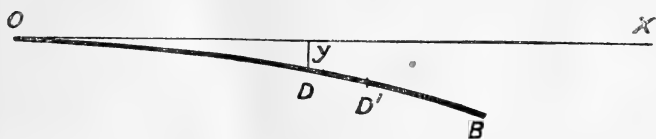

same time the beam is twisted so that, when τ is positive, the lower edge of the beam is further from the straight line OX than the corresponding upper edge.

The force on the part of the beam on one side of D may be considered as made up of the following four actions at D :—

- (1) a bending moment in the vertical plane touching the central line of the beam at D due to vertical forces ;
- (2) a torque about the central line ;
- (3) a vertical shearing force at D ;
- (4) a possible horizontal couple due to fixing the ends.

Let G denote the bending moment at D in the vertical plane, $G+dG$ the bending moment at D' . Let T and $T+dT$ denote the torques at D and D' causing the twist in the beam. Representing these couples by vectors perpendicular to their planes we get the system of couples shown in the next figure.

Fig. 9.

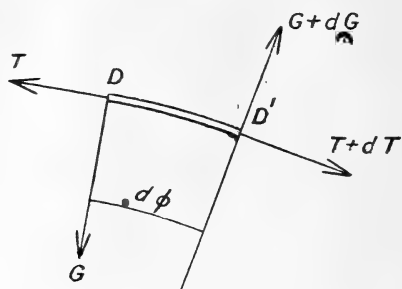

We denote by ϕ the angle between the x -axis and the tangent at D to the central line of the beam, so that $d\phi$ is the change of the angle between D and D' . The vectors for G and $(G+dG)$, being normal to the beam at D and D' , contain the angle $d\phi$.

Resolving the couples on the beam about the tangent at D' we get, to first order,

$$Gd\phi + dT = 0, \dots \dots (71a)$$

whence

$$\frac{dT}{dx} = -G \frac{d\phi}{dx}.$$

But

$$\frac{dy}{dx} = \tan \phi = \phi \text{ nearly.}$$

Therefore

$$\frac{dT}{dx} = -G \frac{d^2y}{dx^2} \dots \dots (71)$$

The moment about the tangent at D' of the shearing force at D , as well as of whatever load there is on the element DD' , has been neglected in the preceding equations because, assuming that the load is on the central line of the beam, this moment is a quantity of at least the second order. The correct equation when the load is not on the central line is given later (equation 101).

Now the bending moment G can be resolved again into a pair of components about lines respectively parallel and

perpendicular to the twisted depth at D (see fig. 10). The former component, of magnitude $G\tau$, bends the central line in a plane perpendicular to the depth of the beam, and this plane of bending is everywhere nearly horizontal. If there

Fig. 10.

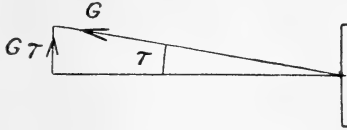

is an end couple M on the beam acting in a horizontal plane, as in clamping the end, then the total couple at D causing bending in a horizontal plane is $G\tau + M$.

Then, since the curvature produced by this couple is the cause of the deflexion y , we get

$$EC \frac{d^2y}{dx^2} = G\tau + M. \quad \dots \quad (72)$$

Equations (71) and (72) are the general differential equations, which, together with the end-conditions of the beam, determine the buckling load when there is no tension or thrust in the beam, and when the load is applied at the centre line of the beam.

Substituting in (71) the value of $\frac{d^2y}{dx^2}$ from (72) we get

$$\frac{dT}{dx} = -\frac{G}{EC} (G\tau + M). \quad \dots \quad (73)$$

From the meaning of K_n we have

$$K_n \times (\text{angle of twist per unit length}) = \text{torque},$$

that is,

$$K_n \frac{d\tau}{dx} = T. \quad \dots \quad (74)$$

Therefore (73) becomes finally

$$ECK_n \frac{d^2\tau}{dx^2} = -G(G\tau + M). \quad \dots \quad (75)$$

It is clear that a tension in the beam would help to stabilize it, and that a thrust would make it less stable, for the beam could buckle under a thrust alone. If a thrust R is applied at the ends of the beam, then an extra term $-Ry$

occurs on the right of (72). Thus

$$EC \frac{d^2y}{dx^2} = G\tau + M - Ry, \dots (76)$$

the term Ry being the bending moment in Euler's theory of struts.

Case 8.—Beam of length l under a pair of balancing couples, each G , at the ends, together with a thrust R (fig. 11).

Fig. 11.

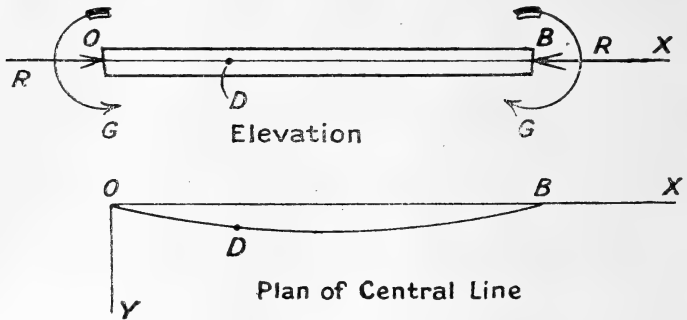

It is understood that the section of the beam has at least one symmetrical axis which is assumed to be vertical, and the length of this axis is several times as long as the greatest horizontal breadth of the section. The end couples mentioned in this problem are in a vertical plane parallel to the length of the beam.

It should be noticed that the direction of G , and therefore of τ , are contrary to their directions in Case 1 in the first paper.

In this case M is zero. Then the equations applying to this case are (71) and (76).

Since G is constant (71) gives

$$T = -G \frac{dy}{dx} + N, \dots (77)$$

or
$$Kn \frac{d\tau}{dx} = -G \frac{dy}{dx} + N. \dots (78)$$

But at the middle of the beam τ and y have both maximum or minimum values, and consequently $\frac{d\tau}{dx}$ and $\frac{dy}{dx}$ are both zero. It follows that the constant N is zero.

Integrating again we get

$$Kn\tau = -Gy, \dots \dots \dots (79)$$

no constant being added in this case because both τ and y are zero at the ends. The negative sign on the right side is due to the fact that τ is negative by our convention.

Now equation (76) gives, since M is zero,

$$EC \frac{d^2y}{dx^2} = - \left\{ \frac{G^2}{Kn} + R \right\} y, \dots \dots (80)$$

which is the same equation as for a strut under a thrust $\left(\frac{G^2}{Kn} + R \right)$. By exactly the same reasoning as in Euler's theory of struts instability occurs when

$$\left(\frac{G^2}{Kn} + R \right) = EC \frac{\pi^2}{l^2}. \dots \dots (81)$$

If the couple G is zero then we get Euler's value of the thrust, namely

$$R = EC \frac{\pi^2}{l^2},$$

and if R is zero we get the value of the end couple G that causes instability when no thrust acts, namely

$$G = \frac{\pi}{l} \sqrt{EnCK},$$

which result has already been obtained in Case 1 in the first paper.

If the end force is a tension of magnitude R' we need only put $-R'$ for R , and then we find

$$\frac{G^2}{Kn} - R' = EC \frac{\pi^2}{l^2} \dots \dots (82)$$

From this it follows that a very big couple could be applied at each end and the beam would remain stable provided a suitable tension R' is also applied. That is, the tension wholly or partially neutralizes the effect of the end couples in producing instability, while the couple G weakens the beam when used as a strut.

Case 9.—Beam under the same forces as in the last case with the addition of a pair of couples in horizontal planes applied at the ends to keep $\frac{dy}{dx}$ zero at those points.

This corresponds to a strut with clamped ends, and differs

from Case 2 only in having a thrust in addition to the couples.

Equation (79) is true in this case as in the last. In equation (76) M is not zero for this case, and therefore the equation corresponding to (80) is

$$EC \frac{d^2y}{dx^2} = - \left\{ \frac{G^2}{Kn} + R \right\} y + M \dots (83)$$

This is the same equation as for a strut with clamped ends and a thrust $\left(\frac{G^2}{Kn} + R \right)$. Also the rest of the conditions for the beam are the same as for the strut. Therefore, by analogy with the strut,

$$\frac{G^2}{Kn} + R = \frac{4\pi^2 EC}{l^2} \dots (84)$$

If a tension R' is applied instead of the thrust R the equation becomes

$$\frac{G^2}{Kn} - R' = \frac{4\pi^2 EC}{l^2}.$$

It should be observed that the two cases just worked out can be regarded as solutions of the strut problem. Suppose the two thrusts at the end are each applied at distance p from the centre of the end section in the direction parallel to the depth as in fig. 12. Then the couple G is Rp and the

Fig. 12.

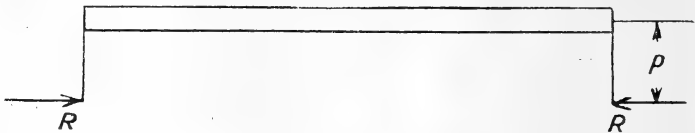

thrust at which instability begins for a pair of free ends is R given by equation (81), that is, by the equation

$$R + \frac{R^2 p^2}{Kn} = EC \frac{\pi^2}{l^2} \dots (85)$$

If Rp^2 is small compared with Kn we may use the approximate equation

$$\begin{aligned} R &= EC \frac{\pi^2}{l^2} - \frac{p^2}{Kn} \left(EC \frac{\pi^2}{l^2} \right)^2 \\ &= EC \frac{\pi^2}{l^2} \left\{ 1 - \frac{\pi^2 p^2 EC}{l^2 Kn} \right\}. \end{aligned}$$

Without assuming that R is small we see that equation (85) gives a pair of roots with opposite signs. The negative root indicates a tension, and thus we see that the beam could buckle under a tension applied in a line parallel to the unstrained central line but not along it. Since the sum of the roots of the equation is negative, it follows that the tension that would cause buckling is greater than the thrust that must be applied in the same line. Moreover, if p is small then the tension at which buckling occurs is very great, and an approximate value is obtained by dropping the term on the right of (85). This approximate value is

$$-R = \frac{Kn}{p^2}.$$

This is a very remarkable result in that this tension is independent of the flexural rigidity of the beam.

In the first paper the loads were all taken on the centre of the sections of the beam. Two cases will now be worked out to show the effect of taking a load slightly off the centre of the beam.

Case 10.—Beam built into a support at one end and free at the other where a load P is applied.

Fig. 13.

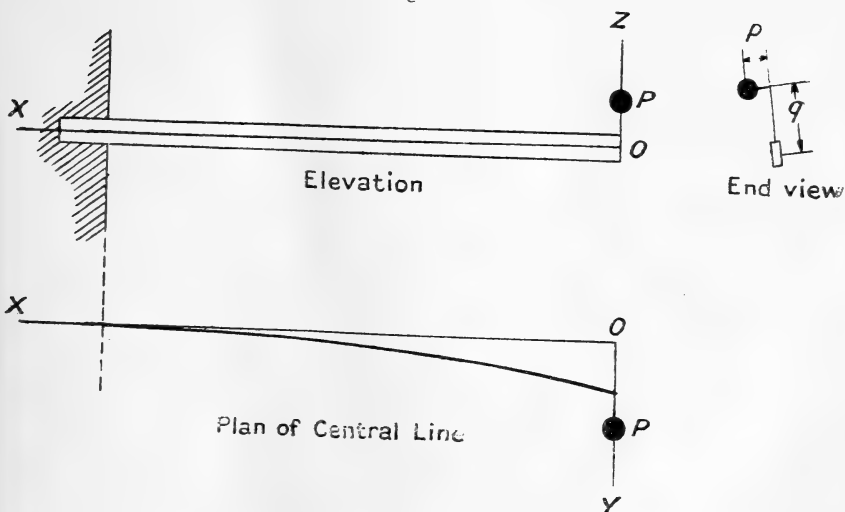

The load P , before the beam is strained, is situated at (o, p, q) referred to three rectangular axes through the free end, as indicated in fig. 13.

The origin being at the free end of the beam the bending moment at x is

$$G = Px,$$

and therefore equation (75) gives

$$ECKn \frac{d^2\tau}{dx^2} = -P^2x^2\tau,$$

$$\text{or} \quad \frac{d^2\tau}{dx^2} = -m^4x^2\tau, \quad \dots \dots (86)$$

$$\text{where} \quad m^4 = \frac{P^2}{EnCK}. \quad \dots \dots (87)$$

This is exactly the same equation as for Case 3 in the first paper. The only difference is in the end conditions. These conditions are now

$$\tau = 0 \text{ where } x = l, \quad \dots \dots (88)$$

$$-Kn \frac{d\tau}{dx} = \text{torque} \\ = P(q\tau + p) \text{ where } x = 0. \quad \dots (89)$$

The negative sign is necessary because τ decreases as x increases.

The solution of equation (86) in series is

$$\tau = a \left\{ x - \frac{m^4x^5}{4.5} + \frac{m^8x^9}{4.5.8.9} - \dots \right\} \\ + b \left\{ 1 - \frac{m^4x^4}{3.4} + \frac{m^8x^8}{3.4.7.8} - \dots \right\}. \quad \dots (90)$$

Now condition (89) gives

$$Kna = -P(qb + p), \quad \dots \dots (91)$$

and condition (88) gives

$$0 = al \left\{ 1 - \frac{m^4l^4}{4.5} + \frac{m^8l^8}{4.5.8.9} - \dots \right\} \\ + b \left\{ 1 - \frac{m^4l^4}{3.4} + \frac{m^8l^8}{3.4.7.8} - \dots \right\}. \quad \dots (92)$$

Substituting the value of a from (91) in equation (92), and writing s for m^4l^4 , we get

$$- \frac{Pl(qb + p)}{Kn} \left\{ 1 - \frac{s}{4.5} + \frac{s^2}{4.5.8.9} - \dots \right\} \\ + b \left\{ 1 - \frac{s}{3.4} + \frac{s^2}{3.4.7.8} - \dots \right\} = 0. (93)$$

Now the value of P which makes b infinite will make τ infinite except at the fixed end. That is, the beam is unstable for that value of P which makes the coefficient of b zero in equation (93). The condition for instability is, therefore,

$$-\frac{Plq}{Kn} \left\{ 1 - \frac{s}{4.5} + \frac{s^2}{4.5 \cdot 8.9} - \right\} + \left\{ 1 - \frac{s}{3.4} + \frac{s^2}{3.4 \cdot 7.8} - \right\} = 0. \quad (94)$$

It should be observed that this equation is independent of p , which shows that the stability is not affected by putting the load a little to one side of the centre. The only result of displacing the load laterally is to put a torsion on the beam, thus giving a new equilibrium state of the beam from which instability begins.

Let us write, for shortness,

$$f(s) = 1 - \frac{s}{4.5} + \frac{s^2}{4.5 \cdot 8.9} - ,$$

$$F(s) = 1 - \frac{s}{3.4} + \frac{s^2}{3.4 \cdot 7.8} - .$$

Then our equation for the load is

$$-\frac{Plq}{Kn} f(s) + F(s) = 0. \quad . \quad . \quad . \quad (95)$$

An approximate solution of this is the solution of the equation

$$F(s) = 0, \quad . \quad . \quad . \quad . \quad (96)$$

since the other term is small because q is small.

Let s_1 denote the solution of (96), and let P_1 be the corresponding value of P . P_1 is, of course, the value of P found in Case 3. In the small term in equation (95) we may use the approximate value P_1 for P . Then writing δ for $\frac{P_1 l q}{Kn}$, and $(s_1 + z)$ for s , equation (95) becomes

$$-\delta f'(s_1 + z) + F(s_1 + z) = 0.$$

Since z is small,

$$F(s_1 + z) = F(s_1) + zF'(s_1) \text{ approximately} \\ = 0 + zF'(s_1).$$

Then taking account of the first powers of δ and z only we get

$$-\delta f'(s_1) + zF'(s_1) = 0.$$

Now

$$F'(s_1) = -\frac{1}{3 \cdot 4} \left\{ 1 - \frac{2s_1}{7 \cdot 8} + \frac{3s_1^2}{7 \cdot 8 \cdot 11 \cdot 12} - \right\}$$

$$= -\frac{1}{3 \cdot 4} \left\{ 1 - \frac{s_1}{4 \cdot 7} + \frac{s_1^2}{4 \cdot 7 \cdot 8 \cdot 11} - \right\},$$

and, from the result of Case 3,

$$s_1 = \frac{P_1^2 l^4}{EnCK} = 4 \cdot 012^2 = 16 \cdot 096.$$

The results of tedious arithmetic are

$$f(s_1) = 0 \cdot 3577,$$

$$F'(s_1) = -0 \cdot 04344.$$

Therefore

$$z = -\frac{0 \cdot 3577}{0 \cdot 04344} \delta$$

$$= -8 \cdot 23 \frac{P_1 l q}{Kn}.$$

Hence

$$s = s_1 + z,$$

$$\frac{s}{s_1} = \left(1 + \frac{z}{s_1} \right),$$

and

$$\sqrt{\frac{s}{s_1}} = 1 + \frac{1}{2} \frac{z}{s_1}$$

$$= 1 + \frac{1}{2} \frac{1}{\sqrt{s_1}} \frac{z}{\sqrt{s_1}}$$

$$= 1 + \frac{1}{2 \times 4 \cdot 012} \left(-\frac{8 \cdot 23 P_1 l q \sqrt{EnCK}}{P_1 l^2 Kn} \right)$$

$$= 1 - 1 \cdot 025 \frac{q}{l} \sqrt{\frac{EC}{Kn}}.$$

Finally

$$Pl^2 = \sqrt{s} \times \sqrt{EnCK}$$

$$= 4 \cdot 012 \left\{ \sqrt{EnCK} - 1 \cdot 025 \frac{q}{l} EC \right\} \dots (97)$$

The critical Euler load for this beam, when used as a strut and supported in the same way (fig. 14), is

$$R = \frac{\pi^2 EC}{4 l^2} \dots (98)$$

Now it is worth while to note that the correction to the buckling load due to putting the load at height q above the centre of the end instead of at that centre is

$$4.012 \times 1.025 \frac{q}{l} \frac{EC}{l^2} = \frac{4.012 \times 1.025 \times 4}{\pi^2} \frac{q}{l} R$$

$$= 1.666 \frac{q}{l} R, \dots (99)$$

thus showing once again the intimate connexion between the strut problem and the buckling beam problem.

Fig. 14.



Case 11.—Beam under a total load W distributed as a uniform load w per unit length, the load at x being situated, before the beam is strained, at (x, p, q) . The beam is fixed at one end and free at the other as in the last case.

We have now to extend equation (71 a) to the case where the distributed load is not on the central line.

Dealing with the element in fig. 9 we find that the load $w dx$, when the beam is twisted, has a torque $w dx(q\tau + p)$ about the tangent at D' . Then, instead of (71 a), we get

$$G d\phi + dT + w dx(q\tau + p) = 0, \dots (100)$$

and instead of (71)

$$\frac{d^2\Gamma}{dx^2} = -G \frac{d^2y}{dx^2} - (q\tau + p)w, \dots (101)$$

which, when $M=0$, as in the present case, is equivalent to

$$Kn \frac{d^2\tau}{dx^2} = -\frac{G^2}{E C} \tau - (q\tau + p)w. \dots (102)$$

This is the general equation when the load is off the centre and there is no couple M at the ends. In the present problem, the origin being taken at the free end, $G = \frac{1}{2}wx^2$, and therefore

$$Kn \frac{d^2\tau}{dx^2} = - \left(\frac{w^2x^4}{4EC} + wq \right) \tau - wp. \quad \dots (103)$$

Whether p and q are functions of x or constants the solution has the form

$$\tau = a_0f(x) + a_1F(x) + \phi(x), \quad \dots (104)$$

where $\phi(x)$ is a particular integral corresponding to $-wp$.

The conditions to be satisfied at the ends are

$$\frac{d\tau}{dx} = 0 \text{ where } x = 0,$$

and $\tau = 0$ where $x = l$.

These give $0 = a_0f'(0) + a_1F'(0) + \phi'(0),$

and $0 = a_0f(l) + a_1F(l) + \phi(l).$

Eliminating a_1 from these we get

$$0 = a_0 \{ f'(0)F(l) - f(l)F'(0) \} + \phi(0)F(l) - \phi(l)F'(0). \quad \dots (105)$$

Now the analytical condition for instability is that a_0 should be infinite, and this can only occur if the coefficient of a_0 in (105) is zero; that is, the condition for instability is

$$f'(0)F(l) - f(l)F'(0) = 0, \quad \dots (106)$$

which is independent of ϕ and therefore of p .

We have now shown, as in the last case, that p has nothing to do with stability.

Since p does not affect stability we can drop it from our equations. Then, assuming that q is constant, equation (103) becomes, when p is dropped,

$$\frac{d^2\tau}{dx^2} = - (m^6x^4 + c^2)\tau, \quad \dots (107)$$

where

$$m^6 = \frac{w^2}{4EnCK}, \quad \dots (108)$$

$$c^2 = \frac{wq}{Kn}. \quad \dots (109)$$

Now the assumption is being made that q is small, and

the problem is to find τ when q is zero and then correct for q (or c^2).

When c is zero the solution of (107) that satisfies all the conditions of the problem is

$$\tau = a_0 \left\{ 1 - \frac{m^6 x^6}{5.6} + \frac{m^{12} x^{12}}{5.6.11.12} - \dots \right\}, \quad (110)$$

m being given by the following equation, taken from Case 6 in the first paper,

$$m^6 l^6 = 41.30. \quad (111)$$

The value of τ in (110) being denoted by τ_1 the equation we have to solve is approximately

$$\frac{d^2 \tau}{dx^2} + m^6 x^4 \tau = -c^2 \tau_1, \quad (112)$$

the term on the right being now regarded as a known function of x . This process amounts to treating c^4 as negligible while c^2 is not negligible.

The particular integral of (112) is

$$\begin{aligned} \tau = & -a_0 c^2 x^2 \left\{ \frac{1}{1.2} - \frac{m^6 x^6}{7.8} \left(\frac{1}{1.2} + \frac{1}{5.6} \right) \right. \\ & + \frac{m^{12} x^{12}}{13.14} \left(\frac{1}{1.2.7.8} + \frac{1}{5.6.7.8} + \frac{1}{5.6.11.12} \right) \\ & - \frac{m^{18} x^{18}}{19.20} \left(\frac{1}{1.2.7.8.13.14} + \frac{1}{5.6.7.8.13.14} \right. \\ & \left. \left. + \frac{1}{5.6.11.12.13.14} + \frac{1}{5.6.11.12.17.18} \right) + \dots \right\} \\ = & -a_0 c^2 x^2 F(m^6 x^6), \text{ say.} \quad (113) \end{aligned}$$

Then the complete value of τ that satisfies the condition that the torque is zero at the free end where $x=0$ is

$$\begin{aligned} \tau = & \tau_1 - a_0 c^2 x^2 F(m^6 x^6) \\ = & a_0 f(m^6 x^6) - a_0 c^2 x^2 F(m^6 x^6), \quad (114) \end{aligned}$$

where $f(m^6 x^6)$ is the series in the brackets in equation (110).

The other condition that has to be satisfied is that $\tau=0$ when $x=l$. Therefore

$$0 = f'(m^6 l^6) - c^2 l^2 F(m^6 l^6). \quad (115)$$

Let s be written for the value of $m^6 l^6$ satisfying

$$f(m^6 l^6) = 0, \dots \dots \dots (116)$$

that is, $s = 41.30, \dots \dots \dots (117)$

as given in equation (111). Then let the solution of equation (115) for $m^6 l^6$ be written

$$m^6 l^6 = s + v.$$

Actually equation (115) has to be solved for w which is involved in both c and m , but since the term involving c is small, we can use, in the expression for c , the approximate value of w given by (111).

Now equation (115) becomes

$$\begin{aligned} 0 &= f(s+v) - c^2 l^2 F(s+v) \\ &= f(s) + v f'(s) - c^2 l^2 F(s) \end{aligned}$$

as far as terms of the first dimension in v and c^2 .

But $f(s) = 0$ by (116). Therefore

$$v = c^2 l^2 \frac{F(s)}{f'(s)} \dots \dots \dots (118)$$

Since

$$f(s) = 1 - \frac{s}{5.6} + \frac{s^2}{5.6.11.12} - \frac{s^3}{5.6.11.12.17.18} +,$$

therefore

$$f'(s) = -\frac{1}{5.6} + \frac{2s}{5.6.11.12} - \frac{3s^2}{5.6.11.12.17.18} +.$$

With the value of s given in (117) we find that

$$f'(s) = -\frac{0.4890}{30}$$

and

$$F(s) = 0.1888.$$

Therefore

$$\begin{aligned} v &= -\frac{0.1888 \times 30}{0.4890} c^2 l^2 \\ &= -11.54 c^2 l^2 \\ &= -11.54 \frac{w_1 q l^2}{K n}, \dots \dots \dots (119) \end{aligned}$$

where w_1 is the value of w given by (111); that is,

$$w_1 l^3 = 2 \sqrt{41.30 E n C K}.$$

Then

$$v = -\frac{2 \times 11.54q}{Kn l} \sqrt{41.3 \overline{EnCK}} \quad . \quad . \quad (120)$$

and

$$\begin{aligned} m^6 l^6 &= 41.30 - \frac{23.08q}{l} \sqrt{\frac{41.3 \overline{EC}}{Kn}} \\ &= 41.30 \left\{ 1 - \frac{23.08}{\sqrt{41.3}} \frac{q}{l} \sqrt{\frac{\overline{EC}}{Kn}} \right\}. \quad . \quad (121) \end{aligned}$$

Consequently, W being the total load,

$$\begin{aligned} Wl^2 &= m^3 l^3 \sqrt{4 \overline{EnCK}} \\ &= 2 \sqrt{41.30} \sqrt{\overline{EnCK}} \left\{ 1 - \frac{23.08}{2} \frac{q}{\sqrt{41.3} l} \sqrt{\frac{\overline{EC}}{Kn}} \right\} \\ &= 12.85 \sqrt{\overline{EnCK}} - 23.1 \frac{q}{l} \overline{EC}. \quad . \quad . \quad . \quad (122) \end{aligned}$$

Thus the correction to Wl^2 due to the distribution of the load along a line at height q above the centre line of the beam instead of along the centre line itself is $23.1 \frac{q}{l} \overline{EC}$.

If the load were below the centre by an amount q the term involving q would be added instead of subtracted, the beam being in that case more stable than with the same load on the central line.

The problem of the stability of a beam fixed at one end and free at the other was worked out in the first paper for the following two cases: firstly, with a load P at the free end and no other load; secondly, with a uniform load per foot and no load on the end. Now we will try to combine these two loads.

Case 12.—Beam fixed at one end and free at the other, and carrying a load P at the free end and a small uniformly distributed load in addition. To find the condition for instability.

It is assumed that the load on the end is much greater than the uniformly distributed load.

Let w be the uniform load per unit length. Then the bending moment G at distance x from the free end is

$$G = Px + \frac{1}{2} wx^2. \quad . \quad . \quad . \quad (123)$$

Therefore, neglecting $\frac{1}{4} \frac{w^2 x^2}{P^2}$ compared with unity,

$$G^2 = P^2 x^2 + Pwx^3. \quad . \quad . \quad . \quad (124)$$

Consequently the differential equation for the twist τ is

$$\begin{aligned} \text{Kn} \frac{d^2\tau}{dx^2} &= -\frac{P^2x^2 + Pwx^3}{EC} \tau \\ &= -\frac{P^2x^2}{EC} \left(1 + \frac{wx}{P}\right) \tau. \dots (125) \end{aligned}$$

Let $\tau = \tau_1 + \rho, \dots (126)$

where τ_1 is the solution of the equation

$$\text{Kn} \frac{d^2\tau_1}{dx^2} = -\frac{P^2x^2}{EC} \tau_1, \dots (127)$$

that is, τ_1 is the value of τ for the case where $w=0$, which is the problem solved in Case 3 in the first paper.

In the present case,

$$\text{Kn} \left\{ \frac{d^2\tau_1}{dx^2} + \frac{d^2\rho}{dx^2} \right\} = -\frac{P^2x^2}{EC} \left\{ 1 + \frac{wx}{P} \right\} \left\{ \tau_1 + \rho \right\}.$$

Now w is a small quantity and ρ , being due to w , is therefore also small. Then neglecting the product $w\rho$ we get

$$\text{Kn} \left\{ \frac{d^2\tau_1}{dx^2} + \frac{d^2\rho}{dx^2} \right\} = -\frac{P^2x^2}{EC} \left\{ \tau_1 + \rho + \frac{wx}{P} \tau_1 \right\}. (128)$$

By using equation (127) this last equation becomes

$$\text{Kn} \frac{d^2\rho}{dx^2} = -\frac{P^2x^2}{EC} \left\{ \rho + \frac{wx}{P} \tau_1 \right\}, \dots (129)$$

that is,

$$\frac{d^2\rho}{dx^2} = -m^4x^2(\rho + rx\tau_1), \dots (130)$$

where

$$m^4 = \frac{P^2}{EnCK}, \dots (131)$$

$$r = \frac{w}{P}, \dots (132)$$

and, by equation (22) in the first paper,

$$\tau_1 = b \left\{ 1 - \frac{m^4x^4}{3 \cdot 4} + \frac{m^8x^8}{3 \cdot 4 \cdot 7 \cdot 8} - \dots \right\}.$$

The particular integral of (129) is

$$\begin{aligned} \rho = -rb \left\{ \frac{m^4x^5}{4 \cdot 5} - \frac{8m^8x^9}{3 \cdot 4 \cdot 5 \cdot 8 \cdot 9} \right. \\ \left. + \frac{101m^{12}x^{13}}{3 \cdot 4 \cdot 5 \cdot 7 \cdot 8 \cdot 9 \cdot 12 \cdot 13} - \dots \right\}. (133) \end{aligned}$$

The condition to be satisfied at the free end of the beam is that the torque is zero, that is,

$$\frac{d\tau}{dx} = 0, \text{ where } x=0.$$

This condition is satisfied by the value of τ in (126) if ρ has the value given by (133).

The other condition is that

$$\tau = 0 \text{ where } x=l.$$

Let

$$\tau_1 = bf(m^2x^2),$$

$$\rho = -rbxF(m^2x^2).$$

Then we have to solve the following equation for m^2l^2

$$bf(m^2l^2) - rblF(m^2l^2) = 0. \quad \dots \quad (134)$$

Let

$$m^2l^2 = s + v$$

where

$$f(s) = 0, \quad \dots \quad (135)$$

that is, from equation (25),

$$s = 4.012. \quad \dots \quad (136)$$

Then

$$f(s+v) - r l F(s+v) = 0,$$

or

$$f'(s) + v f''(s) - r l F'(s) = 0, \quad \dots \quad (137)$$

on neglecting v^2 , rv , and small quantities of higher orders.

Equations (135) and (137) give

$$v = r l \frac{F'(s)}{f''(s)}.$$

After the necessary arithmetic we arrive at the results

$$F(s) = 0.1014 \times s,$$

$$F'(s) = -0.0869 \times s.$$

Therefore

$$v = -1.167rl$$

$$= -1.167 \frac{wl}{P_0}$$

$$= -1.167 \frac{W}{P_0}.$$

W being the total distributed load, and P_0 the buckling load when W is zero.

Finally,

$$m^2 l^2 = s - 1.167 \frac{W}{P_0},$$

or
$$\frac{Pl^2}{\sqrt{EnCK}} = 4.012 - 1.167 \frac{W}{P_0}$$

$$= 4.012 \left\{ 1 - 0.291 \frac{W}{P_0} \right\}.$$

Therefore

$$P = 4.012 \frac{\sqrt{EnCK}}{l^2} \left\{ 1 - 0.291 \frac{W}{P_0} \right\}$$

$$= P_0 \left\{ 1 - 0.291 \frac{W}{P_0} \right\}$$

$$= P_0 - 0.291 W, \quad \dots \dots \dots (138)$$

whence

$$P + 0.291 W = P_0 = \frac{4.012}{l^2} \sqrt{EnCK}. \quad \dots \dots \dots (139)$$

The above is the equation that holds just when instability occurs provided W is very small compared with P .

Now the buckling load when P is zero is, by Case 6,

$$W = \frac{12.86}{l^2} \sqrt{EnCK}.$$

Therefore the equation

$$\frac{Pl^2}{4.012} + \frac{Wl^2}{12.86} = \sqrt{EnCK} \quad \dots \dots \dots (140)$$

is true in two cases:

- (1) when $P = 0$,
- (2) when $W = 0$.

Moreover, this last equation can be written

$$P + 0.312 W = P_0, \quad \dots \dots \dots (141)$$

which does not differ much from (139). It seems very probable then that equation (140) will be a good one for all values of the ratio of W to P .

If the ratio between W and P is fixed it is possible to find the actual values of these loads when buckling occurs, but the problem is very awkward unless one of the loads is small compared with the other. It is worth while, however, to work out the case where P is small compared with W , so as to see if equation (140) remains approximately true in one more case. This we will now do.

Case 13.—The same problem as Case 12 except that the load P on the end is small compared with the uniformly distributed load W.

Here, as in the last case,

$$G = Px + \frac{1}{2}wx^2.$$

But

$$\begin{aligned} G^2 &= \frac{1}{4}w^2x^4 \left(1 + \frac{2P}{wx}\right)^2, \\ &= \frac{1}{4}w^2x^4 \left(1 + \frac{4P}{wx}\right) \text{ approximately.} \end{aligned}$$

Therefore

$$\begin{aligned} \frac{d^2\tau}{dx^2} &= -\frac{w^2x^4}{4EnCK} \left(1 + \frac{4P}{wx}\right) \tau \\ &= -m^6x^4 \left(1 + \frac{4P}{wx}\right) \tau, \quad \dots \dots (142) \end{aligned}$$

where

$$m^6 = \frac{w^2}{4EnCK}. \quad \dots \dots (143)$$

Now let

$$\tau = \tau_1 + \rho, \quad \dots \dots (144)$$

where

$$\tau_1 = a \left\{ 1 - \frac{m^6x^6}{5 \cdot 6} + \frac{m^{12}x^{12}}{5 \cdot 6 \cdot 11 \cdot 12} - \dots \right\}, \quad \dots (145)$$

and therefore

$$\frac{d^2\tau_1}{dx^2} = -m^6x^4\tau_1. \quad \dots \dots (146)$$

Then equation (142) becomes

$$\begin{aligned} \frac{d^2\tau_1}{dx^2} + \frac{d^2\rho}{dx^2} &= -m^6x^4 \left(1 + \frac{4P}{wx}\right) (\tau_1 + \rho) \\ &= -m^6x^4 \left\{ \tau_1 + \frac{4P}{wx} \tau_1 + \rho \right\}, \end{aligned}$$

neglecting the product Pρ since both factors are small.

By means of equation (146) this last equation gives

$$\frac{d^2\rho}{dx^2} + m^6x^4\rho = -\frac{4Pm^6}{w}x^3\tau_1. \quad \dots \dots (147)$$

Now if we differentiate through (146) we get

$$\frac{d^2\tau_1'}{dx^2} + m^6x^4\tau_1' = -4m^6x^3\tau_1, \quad \dots \dots (148)$$

τ₁' being written for $\frac{d\tau_1}{dx}$.

A comparison of (147) and (148) shows that a particular integral of the former equation is

$$\rho = \frac{P}{w} \tau_1' = \frac{P}{w} \frac{d\tau_1}{dx} \quad \dots \quad (149)$$

Then it follows that

$$\tau = \tau_1 + \frac{P}{w} \frac{d\tau_1}{dx} \quad \dots \quad (150)$$

is a solution of equation (142), and this solution satisfies the condition that the torque is zero at the free end where $x=0$; that is,

$$\frac{d\tau}{dx} = 0 \quad \text{where } x=0.$$

The only other condition that it is necessary to satisfy is that

$$\tau = 0 \quad \text{where } x=l,$$

that is,

$$\tau_1 + \frac{P}{w} \frac{d\tau_1}{dx} = 0 \quad \text{where } x=l, \quad \dots \quad (151)$$

and from this equation m is to be found.

$$\text{Let} \quad \tau_1 = f(mx). \quad \dots \quad (152)$$

Then, since $m \frac{P}{w}$ is small,

$$\begin{aligned} f\left(mx + m \frac{P}{w}\right) &= f(mx) + m \frac{P}{w} f'(mx) \\ &= \tau_1 + \frac{P}{w} \frac{d\tau_1}{dx}. \quad \dots \quad (153) \end{aligned}$$

It is now clear that equation (151) can be written in the form

$$f\left(ml + m \frac{P}{w}\right) = 0. \quad \dots \quad (154)$$

But we found in the first paper (equation (55)) that the solution of the equation

$$f(ml) = 0$$

was given by

$$m^3 l^3 = 6.43. \quad \dots \quad (155)$$

It therefore follows that the solution of equation (154) is

$$m^3 \left(l + \frac{P}{w}\right)^3 = 6.43;$$

that is,

$$m^3 l^3 \left(1 + \frac{3P}{W}\right) = 6.43 \quad \text{approximately.}$$

Consequently

$$\frac{Wl^2}{2\sqrt{EnCK}} \left(1 + \frac{3P}{W}\right) = 6.43$$

or

$$\frac{Wl^2}{12.86} + \frac{Pl^2}{4.29} = \sqrt{EnCK}. \quad \dots \quad (156)$$

Now we see that, whether W is small compared with P , or P small compared with W , the result expressed by (140) is nearly true. Then it is sure to be nearly true for all other positive values of the ratio $W : P$. The result may be expressed roughly in the following form:—A load on the free end of the clamped-free beam has approximately the same effect in buckling as three times that load distributed uniformly along the beam.

There is one assumption in the working of the last case that should not be passed over without justifying it. It is the assumption, made in the squaring of G , that P is small compared with wx . This, of course, is quite true everywhere except where x is small. But if we consider that the actual term neglected, namely P^2x^2 , is itself small in the region where there is any possibility of error, and that the assumption is wrong only over a very small range of values of x , it is clear that the error made is negligible.

There is still another point of view that will show the justification for this assumption. The actual method of solution consists in dropping a term from G^2 , and if we had added a term of the same order we could have got

$$G^2 = \frac{1}{4}w^2 \left(x + \frac{P}{w}\right)^4.$$

Then, by changing the variable to $\left(x + \frac{P}{w}\right)$, our differential equation would have reduced to the same form as in Case 6 where P was zero. It is easy to show by this method that the solution of Case 6, with $\left(x + \frac{P}{w}\right)$ for x and $\left(l + \frac{P}{w}\right)$ for l , applies correctly to the present case provided powers of $\frac{mP}{w}$ beyond the first are neglected. But this is precisely the solution we have obtained by taking a different value of G^2 . Then it follows that the term neglected in G^2 does not affect the result to our degree of approximation.

Case 14.—Beam carrying a small uniformly distributed load W and a much larger concentrated load P at the middle,

and supported at the ends with just the necessary forces and couples to keep the depth of the end sections upright.

This is a combination of Cases 4 and 7 in the first paper with the condition that the ratio of W to P is small.

In this case, taking the origin at one end,

$$G = \frac{1}{2}(P + W)x - \frac{1}{2} \frac{W}{l} x^2$$

$$= \frac{1}{2} Qx - \frac{1}{2} \frac{W}{l} x^2, \dots \dots \dots (157)$$

Q being written for $(P + W)$.

Therefore

$$\frac{d^2\tau}{dx^2} = - \frac{Q^2 x^2}{4EnCK} \left\{ 1 - \frac{Wx}{Ql} \right\}^2 \tau$$

$$= -m^4 x^2 \left\{ 1 - \frac{2Wx}{Ql} \right\} \tau \text{ approximately, } (158)$$

where

$$m^4 = \frac{Q^2}{4EnCK} \dots \dots \dots (159)$$

If we also write r for the small quantity $\frac{2W}{Ql}$, then

$$\frac{d^2\tau}{dx^2} + m^4 x^2 = m^4 r x^3 \tau. \dots \dots \dots (160)$$

Now let

$$\tau = \tau_1 + \rho, \dots \dots \dots (161)$$

where

$$\tau_1 = a \left\{ x - \frac{m^4 x^5}{4.5} + \frac{m^8 x^9}{4.5.8.9} - \dots \dots \dots \right\}, \dots (162)$$

and therefore

$$\frac{d^2\tau_1}{dx^2} + m^4 x^2 \tau_1 = 0. \dots \dots \dots (163)$$

Then (160) becomes, after making use of (163),

$$\frac{d^2\rho}{dx^2} + m^4 x^2 \rho = m^4 r x^3 \tau_1, \dots \dots \dots (164)$$

the product of the pair of small quantities r and ρ being neglected.

A particular integral of (164) in series is

$$\rho = a \frac{m^4 r}{5.6} x^6 \left\{ 1 - \frac{m^4 x^4}{4.9} + \frac{m^8 x^8}{4.8.9.13} \right.$$

$$\left. - \frac{m^{12} x^{12}}{4.8.9.12.13.17} + \dots \right\}. \dots (165)$$

If we use this value of ρ in (161) we get a solution which

satisfies the condition that $\tau=0$ where $x=0$, which is one of the conditions of the problem.

Another condition is that the torque is zero at the middle. This follows from symmetry, for clearly neither half can be exerting a torque on the other. Then

$$\frac{d\tau_1}{dx} + \frac{d\rho}{dx} = 0 \text{ when } x = \frac{1}{2}l, \quad \dots \quad (166)$$

that is, writing u for $(\frac{1}{2}ml)^4$,

$$\begin{aligned} a \left\{ 1 - \frac{u}{4} + \frac{u^2}{4 \cdot 5 \cdot 8} - \frac{u^3}{4 \cdot 5 \cdot 8 \cdot 9 \cdot 12} + \dots \right\} \\ + a \frac{rlu}{2 \cdot 5 \cdot 6} \left\{ 6 - \frac{10u}{4 \cdot 9} + \frac{14u^2}{4 \cdot 8 \cdot 9 \cdot 13} \right. \\ \left. - \frac{18u^3}{4 \cdot 8 \cdot 9 \cdot 12 \cdot 13 \cdot 17} + \dots \right\} = 0. \quad \dots \quad (167) \end{aligned}$$

Now let

$$f(u) = 1 - \frac{u}{4} + \frac{u^2}{4 \cdot 5 \cdot 8} - \dots$$

$$F(u) = 6u - \frac{10u^2}{4 \cdot 9} + \frac{14u^3}{4 \cdot 8 \cdot 9 \cdot 13} - \dots$$

then our equation is

$$f(u) + \frac{rl}{60} F(u) = 0. \quad \dots \quad (168)$$

Let us put

$$u = s + v,$$

where s is the solution when $W=0$; that is,

$$f(s) = 0, \quad \dots \quad (169)$$

and, by equation (33) in the first paper,

$$s = 4.482. \quad \dots \quad (170)$$

Then, retaining only the first powers of v and v and no products, equation (168) becomes

$$f(s) + vf'(s) + \frac{rl}{60} F(s) = 0,$$

or

$$vf''(s) + \frac{rl}{60} F(s) = 0.$$

Therefore

$$v = - \frac{rl F(s)}{60 f''(s)}. \quad \dots \quad (171)$$

After the usual arithmetic we find that

$$F(s) = 21.64,$$

$$f'(s) = -0.1974,$$

whence
$$v = rl \times \frac{21.64}{60 \times 0.1974} = 1.827 \times \frac{2W}{Q}, \quad (172)$$

and consequently

$$\begin{aligned} \frac{1}{16} m^4 l^4 &= s + v = 4.482 + 1.827 \frac{2W}{Q} \\ &= 4.482 \left\{ 1 + 0.407 \times \frac{2W}{Q} \right\}, \end{aligned}$$

$$\frac{1}{4} m^2 l^2 = \sqrt{4.482} \left\{ 1 + 0.407 \frac{W}{Q} \right\},$$

or
$$\frac{1}{8} \frac{Ql^2}{\sqrt{EnCK}} = \sqrt{4.482} \left\{ 1 + 0.407 \frac{W}{Q} \right\}.$$

Therefore, dividing by $\left(1 + 0.407 \frac{W}{Q}\right)$ and treating $\frac{W}{Q}$ as a small fraction,

$$l^2 Q \left\{ 1 - 0.407 \frac{W}{Q} \right\} = 8 \sqrt{4.482} \sqrt{EnCK},$$

or
$$Ql^2 - 0.407 Wl^2 = 16.94 \sqrt{EnCK},$$

whence
$$Pl^2 + 0.593 Wl^2 = 16.94 \sqrt{EnCK}.$$

This result can be written in the form

$$\frac{Pl^2}{16.94} + \frac{Wl^2}{28.6} = \sqrt{EnCK}. \quad (173)$$

Now when P is zero the present problem reduces to Case 7, the solution of which is

$$\frac{Wl^2}{28.31} = \sqrt{EnCK}. \quad (174)$$

But this differs very little from what we should get by putting $P=0$ in (173), which has been obtained on the widely different assumption that W is small compared with P. Then it is very likely that equation (173) is nearly correct for all values of the ratio $W : P$.

The constants EC and K_n , which are involved in the buckling loads, occur merely as constants in equations for bending and torsion respectively; that is, there is no

assumption in this paper as to what Kn means except that

$$Kn = \frac{\text{torque}}{\text{angle of twist per unit length}}.$$

There is no assumption then that K has any particular form such, for example, as is given by St. Venant's theory of torsion. The only assumption is that torque is proportional to twist and that Kn is the constant expressing the quotient obtained on dividing one by the other. Similar remarks apply to EC , but there is no need to lay the same stress on this as on the torsion coefficient because the bending coefficient is better established, although even here C is not rigorously the moment of inertia of the section if E is Young's modulus. The point of the preceding argument is this, that EC and Kn are a pair of coefficients which should be obtained by experiment for any particular beam that is to be used for testing the theory of this paper. It would not be right to calculate EC and Kn , even if E and n were known accurately, for that would be burdening the theory of buckling beams with whatever errors are contained in the theories of bending and of torsion. Of course, when the buckling formulæ have to be used in practice it will usually be necessary to be content with calculated values of C and K and assumed values of E and n , for that will be the best that can be done. But, in the testing of the results in the experiments carried out by Mr. Carrington, EC and Kn are found experimentally and their values substituted in the expressions for buckling loads, and these are compared with the actual experimental buckling loads.

In using the preceding results in practice, where it will usually be necessary to calculate everything, the value of C is the same as in the bending of beams and the best value of K is the one given by St. Venant's theory of torsion. For a beam of rectangular section, breadth b and depth d , these values are

$$C = \frac{1}{12} b^3 d,$$

$$K = \frac{1}{3} b^3 d \left(1 - 0.630 \frac{b}{d} \right),$$

the latter being the approximate value of St. Venant's torsion coefficient when b is less than $\frac{1}{3}d$.

Appendix by H. CARRINGTON.

Experiments were performed to determine the degree of accuracy with which the buckling loads for cantilevers loaded at one end, as calculated by the mathematical expression in (1) below, agreed with those obtained by experiment. Five steel strips were used, each of which was straight, free from dents, and accurately ground.

The expression for the buckling load is

$$P = \frac{4.012 \sqrt{E n C K}}{l^2}, \dots \dots \dots (1)$$

where l is the length under test, EC the least flexural rigidity, and Kn the torsional rigidity, so that in order to calculate P it was first necessary to determine these rigidities.

The flexural rigidity of a strip was obtained by arranging it as a cantilever and loading it with weights suspended from the free end by a fine wire. The deflexions (δ) of the free end corresponding with increasing increments of load were noted and plotted one against the other. The lines so obtained are given in fig. 1, and the flexural rigidity (EC) is

Fig. 1.

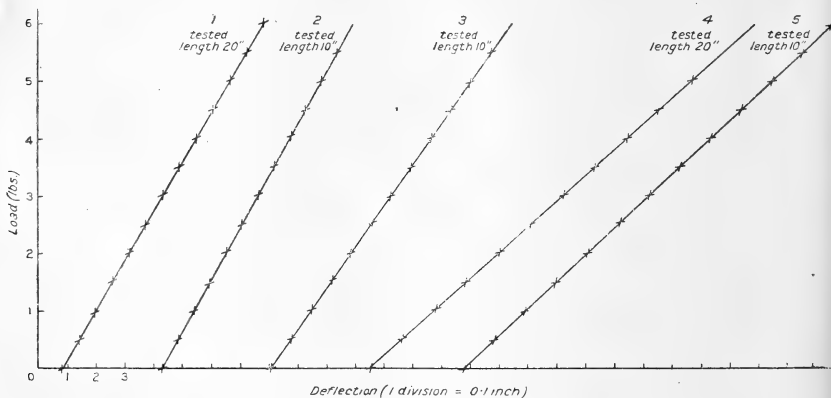

given in each case by the expression $EC = \frac{W l^3}{\delta \cdot 3}$, where $\frac{W}{\delta}$ is the slope of the line and l is the length under test. The thicknesses of the strips (see table below) were small compared with the lengths under test (10 in. and over) and the deflexions due to shear were accordingly negligible.

In order to obtain the torsional rigidities the strips were

fixed in a delicate torsionmeter which was capable of transmitting small torques of known amount, about the longitudinal axes of the specimens. The angles of twist corresponding with different gradations of torque were noted and plotted one against the other, and the curves are reproduced in fig. 2. The torsional rigidity K_n is given by $K_n = \frac{T}{\theta} l$, where $\frac{T}{\theta}$ is the slope of the curve and l is the length of the corresponding strip under test.

Fig. 2.

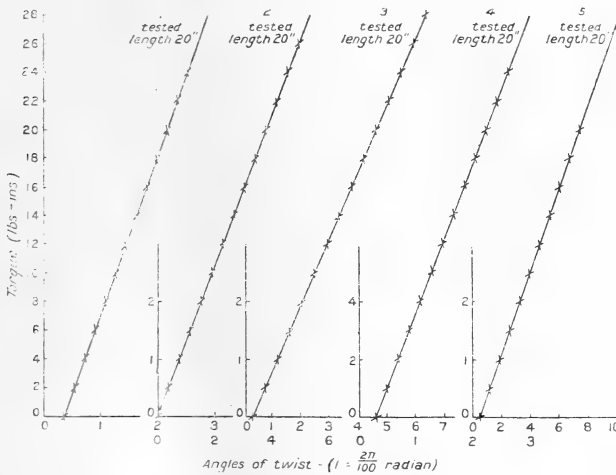

The values of the rigidities for each of the five strips are given in the table (below) and also values of P calculated by the expression (1) and corresponding with two lengths for each strip. It may be noted that no dimensions of the strips other than the lengths under test are involved in equation (1).

The buckling loads were obtained experimentally as follows:—each strip was firmly gripped in a vice and projected horizontally outwards with its sides vertical. The load was transmitted by weights suspended by a fine wire which passed through a small hole drilled through the mid-depth of the specimen near its end. When the buckling load was almost reached the specimen could vibrate slowly from side to side and finally came to rest in the central position. When the buckling load was just past, the

No. of strip.....	1.	2.	3.	4.	5.
Width (ins.).....	1.051	0.975	0.777	0.516	0.503
Thickness (ins.)	0.0990	0.0501	0.0505	0.1000	0.0498
Flexural Rigidity (EI) lb.-in. ²	2315	304	241	1200	157
Torsional Rigidity (K _t) lb.-in. ²	3550	419	371	1680	231
Length tested for buckling (ins.)	15	20	7.5	10	10
Calculated buckling load lb., from $P = 4.012 \frac{\sqrt{EI\alpha K}}{l^2}$	51.1	28.8	25.5	14.4	7.65
Experimental buckling load, lb.	51.0	29.6	26.5	15.1	8.0
Difference, per cent.	0.2	-2.7	-3.8	-4.6	-4.4
			5	10	5
			48.1	57.0	30.6
			12.0	14.2	7.65
			51.0	58.0	8.0
			-5.8	-1.7	-4.4
			-6.2	-8.3	-4.4

(NB.—The edges of strips Nos. 1, 2, and 5, were rounded.)

specimen could still vibrate slowly from side to side, but came to rest in a position displaced on one side or the other of the central position. The buckling load was taken as that which would cause the beam to come to rest so that the displacement from the central position was the smallest appreciable. The results of all the experiments can be seen at a glance from the accompanying table.

It was found of importance that the sides of the strips should be exactly vertical, for if they were very slightly inclined, a displacement was noted at comparatively small loads. A delicate adjustment was necessary, so that when the buckling load was reached the strips would remain at rest, very slightly displaced, on either one side or the other of the central position.

In every case the buckling loads were determined experimentally before their values were calculated by equation (1) in order that the determination of the experimental loads should not be influenced by a knowledge of the calculated values. This was necessary because it was difficult to decide, within 2 or 3 per cent., at what load buckling began.

XX. *Note on a Simple Property of a Refracted Ray.*

By ALICE EVERETT*.

LET AP be a ray incident at a point P on any refracting surface, BP the refracted ray, CPN the normal, C the centre of curvature in the plane of incidence; ϕ , ϕ' the angles of incidence and refraction, and ψ , ψ' the angles CAP, CBP made by the rays with a transversal CAB through C cutting them at A and B. Then $\phi + \psi' = \phi' + \psi = \gamma$, say. The angle γ plays a leading part in some modern optical generalized formulæ (see Optical Society's Transactions, vol. xx. pp. 23-31, Nov. 1918, where it is pointed out that, for a spherical refracting surface, γ is also the angle made with the axis by the line joining C to the points of intersection of the rays with the aplanatic surfaces), but objection has been raised that this angle is not readily visualized. The following simple property which, curiously enough, seems hitherto to have escaped notice, may be of service in this respect.

* Communicated by the Author. From a communication to the Transactions of the Optical Society for March 1919, p. 203.

If PT be the tangent at P to the circle circumscribing the triangle APB , then the angle TPN , between this tangent and the normal produced, is equal to $\phi + \psi' = \gamma$, since the angle APT between this tangent and the chord

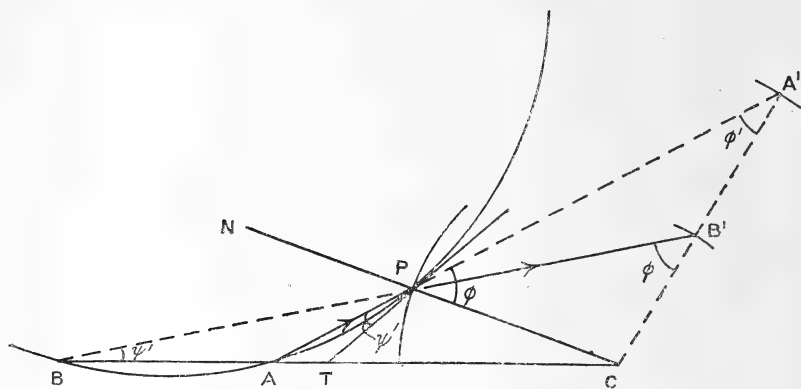

AP is equal to the angle at B in the opposite segment of the circle, and the angle APN is ϕ . Without actually drawing the circle APB , the direction of the tangent can usually be judged by inspection. If now the transversal rotate about C , while the rays remain fixed, the tangent will rotate about P at the same rate, but in the opposite direction, the angle swept through in either case being $\Delta\psi = \text{increment of } \psi = \text{increment of } \psi'$. When $\Delta\psi$ attains the value $\pi - \gamma$, the tangent to the circle coincides with the normal PC to the refracting surface, and if $CB'A'$ be the corresponding position of the transversal, then

$$\begin{aligned} \angle BCB' &= \pi - \gamma, & \angle PB'C &= \phi, & \angle PA'C &= \phi', \\ CA' &= \mu' / \mu \cdot r, & CB' &= \mu / \mu' \cdot r', \end{aligned}$$

μ, μ' being the refractive indices, and r the radius of curvature.

XXI. *On Resonant Reflexion of Sound from a Perforated Wall.* By the late Lord RAYLEIGH, O.M., F.R.S.*

[This paper, written in 1919, was left by the Author ready for press except that the first two pages were missing. The preliminary sentences, taken from a separate rough sheet, were perhaps meant to be expanded.]

Prof. Wood † had observed highly coloured effects in the reflexion from a granular film of sodium or potassium, which he attributed to resonance from the cavities of a serrated structure of rod-like crystals.]

THIS investigation was intended to illustrate some points discussed with Prof. R. W. Wood. But it does not seem to have much application to the transverse vibrations of light. Electric resonators could be got from thin conducting rods $\frac{1}{2}\lambda$ long; but it would seem that these must be disposed with their lengths perpendicular to the direction of propagation, not apparently leading to any probable structure.

The case of sound might perhaps be dealt with experimentally with bird-call and sensitive flame. A sort of wire brush would be used.

The investigation follows the same lines as in 'Theory of Sound,' 2nd ed. § 351 (1896), where the effect of porosity of walls on the reflecting power for sound is considered. In the complete absence of dissipative influences, what is not transmitted must be reflected, whatever may be the irregularities in the structure of the wall. In the paragraph referred to, the dissipation regarded is that due to gaseous viscosity and heat conduction, both of which causes act with exaggerated power in narrow channels. For the present purpose it seems sufficient to employ a simpler law of dissipation.

Let us conceive an otherwise continuous wall, presenting a flat face at $x=0$, to be perforated by a great number of similar narrow channels, uniformly distributed, and bounded by surfaces everywhere perpendicular to the face of the wall. If the channels be sufficiently numerous relatively to the wave-length of vibration, the transition, when sound impinges, from simple plane waves on the outside to the

* Communicated by Sir Joseph Larmor.

† See *Phil. Mag.* July 1919, p. 98-112, especially p. 111, where a verbal opinion of Lord Rayleigh is quoted that in certain cases the grooves of gratings might possibly act as resonators.

waves of simple form in the interior of the channels occupies a space which is small relatively to the wave-length, and then the connexion between the condition of things outside and inside admits of simple expression.

On the outside, where the dissipation is neglected, the velocity potential (ϕ) of the plane waves, incident and reflected in the plane of xy , at angle θ , is subject to

$$d^2\phi/dt^2 = a^2(d^2\phi/dx^2 + d^2\phi/dy^2), \quad \dots \quad (1)$$

or if $\phi \propto e^{int}$, where n is real,

$$d^2\phi/dx^2 + d^2\phi/dy^2 + k^2\phi = 0, \quad \dots \quad (2)$$

k being equal to n/a . The solution of (1) appropriate to our purpose is

$$\phi = e^{i(nt+ky \sin \theta)} \{ A e^{ikx \cos \theta} + B e^{-ikx \cos \theta} \}, \quad \dots \quad (3)$$

the first term representing the incident wave travelling towards $-x$, and the second the reflected wave. From (3) we obtain for the velocity u parallel to x , and the condensation s , when $x=0$,

$$u = \frac{d\phi}{dx} = e^{i(nt+ky \sin \theta)} ik \cos \theta (A - B), \quad \dots \quad (4)$$

$$as = -\frac{1}{a} \frac{d\phi}{dt} = -\frac{in}{a} e^{i(nt+ky \sin \theta)} (A + B), \quad \dots \quad (5)$$

so that

$$\frac{u}{as} = \cos \theta \frac{B - A}{B + A} \dots \dots \dots (6)$$

For the motion inside a channel we introduce in (1) on the left a term $hd\phi/dt$, h being positive, to represent the dissipation. Thus, if ϕ be still proportional to e^{int} , we have in place of (2)

$$d^2\phi/dx^2 + d^2\phi/dy^2 + d^2\phi/dz^2 + k'^2\phi = 0, \quad \dots \quad (7)$$

where k'^2 is now complex, being given by

$$k'^2 = k^2 - inh/a^2. \quad \dots \quad (8)$$

If we write $k' = k_1 - ik_2$, where k_1, k_2 are real and positive, we have

$$k_1^2 - k_2^2 = k^2, \quad k_1 k_2 = \frac{1}{2} nh/a^2. \quad \dots \quad (9)$$

At a very short distance from the mouth of the channel $d^2\phi/dy^2, d^2\phi/dz^2$ in (7) may be neglected, and thus

$$\phi = e^{int} \{ A' \cos k'x + B' \sin k'x \}. \quad \dots \quad (10)$$

If the channel be closed at $x = -l$,

$$A' \sin k'l + B' \cos k'l = 0,$$

and we may take

$$\phi = A'' \cos k'(x+l) e^{int}. \quad \dots \quad (11)$$

From (11) when x is very small,

$$u = d\phi/dx = -k' A'' \sin k'l \cdot e^{int}, \quad \dots \quad (12)$$

$$as = -a^{-1} d\phi/dt = -ik A'' \cos k'l \cdot e^{int}, \quad \dots \quad (13)$$

so that

$$\frac{u}{as} = \frac{k'}{ik} \tan k'l. \quad \dots \quad (14)$$

Now, under the conditions supposed, where the transition from the state of things outside to that inside, at a distance from the mouth large compared with the diameter of a channel, occupies a space which is small compared with the wave-length, we may assume that s is the same in (6) and (14), and that

$$(\sigma + \sigma')u \text{ in (6)} = \sigma u \text{ in (14)},$$

where σ represents the perforated area and σ' the unperforated. Accordingly, if we put $A = 1$, as we may do without loss of generality, the condition to determine B is

$$\frac{B-1}{B+1} = \frac{\sigma}{(\sigma + \sigma') \cos \theta} \frac{k' \tan k'l}{ik} \dots \quad (15)$$

If there be no dissipation in the channels, $h = 0$, and $k' = k$. In this case

$$B = \frac{(\sigma + \sigma') \cos \theta \cos kl - i\sigma \sin kl}{(\sigma + \sigma') \cos \theta \cos kl + i\sigma \sin kl} \dots \quad (16)$$

Here $\text{Mod. } B = 1$, or the reflexion is total, as of course it should be. If in (16) $\sigma = 0$, $B = 1$, the wall being unperforated. On the other hand, if $\sigma' = 0$, the partitions between the channels being infinitely thin,

$$B = \frac{\cos \theta \cos kl - i \sin kl}{\cos \theta \cos kl + i \sin kl} \dots \quad (17)$$

In the case of perpendicular incidence $\theta = 0$, and

$$B = e^{-2kl}, \quad \dots \quad (18)$$

the wall being in effect transferred from $x = 0$ to $x = -l$.

We have now to consider the form assumed when k' is complex. In (15)

$$\left. \begin{aligned} \cos k'l &= \cos k_1 l \cos ik_2 l + \sin k_1 l \sin ik_2 l, \\ \sin k'l &= \sin k_1 l \cos ik_2 l - \cos k_1 l \sin ik_2 l. \end{aligned} \right\} \dots \quad (19)$$

Before proceeding further it may be worth while to deal with the case where h , and consequently k_2 , is very small, but k_2l so large that vibrations in the channels are sensibly extinguished before the stopped end is reached. In this case

$$\cos ik_2l = \frac{1}{2}e^{k_2l}, \quad \sin ik_2l = \frac{1}{2}ie^{k_2l},$$

so that in (19), $\tan k'l = -i$. Also by (9), $k'/k = 1$, and (15) becomes

$$\frac{B-1}{B+1} = -\frac{\sigma}{(\sigma + \sigma') \cos \theta}, \quad \dots \quad (20)$$

making $B=0$ when, for example, $\sigma'=0$, $\cos \theta=1$. The reflexion may also vanish when the obliquity of incidence is such as to compensate for a finite σ' .

In examining the formula for the general case we shall write for brevity

$$\cos \theta(\sigma + \sigma')/\sigma = S, \quad \dots \quad (21)$$

and drop l , so that k_1, k_2, k stand respectively for k_1l, k_2l, kl . This makes no difference to the first of equations (9), while the second becomes

$$k_1k_2 = \frac{1}{2}nhl^2/a^2. \quad \dots \quad (9 \text{ bis})$$

Thus

$$B = \frac{kS \cos k' - ik' \sin k'}{kS \cos k' + ik' \sin k'}. \quad \dots \quad (22)$$

Separating real and imaginary parts, we find for the numerator of B in (22)

$$\begin{aligned} \cos k_1 \cos ik_2 \left[kS - \frac{k_1 \tan ik_2}{i} - k_2 \tan k_1 \right. \\ \left. + i \left\{ kS \tan k_1 \frac{\tan ik_2}{i} - k_1 \tan k_1 + \frac{k_2 \tan ik_2}{i} \right\} \right]. \quad (23) \end{aligned}$$

The denominator of (22) is obtained (with altered sign) by writing $-S$ for S in (23).

In what follows we are concerned with the modulus of B . Leaving out factors common to the numerator and denominator, we may take

$$\begin{aligned} \text{Mod.}^2 \text{ Numerator} = \left\{ kS - \frac{k_1 \tan ik_2}{i} - k_2 \tan k_1 \right\}^2 \\ + \left\{ \left(kS \frac{\tan ik_2}{i} - k_1 \right) \tan k_1 + \frac{k_2 \tan ik_2}{i} \right\}^2. \quad (24) \end{aligned}$$

The evanescence of B requires that of both the squares in (24), or that

$$kS = \frac{k_1 \tan ik_2}{i} + k_2 \tan k_1 = ik_1 \cot ik_2 - k_2 \cot k_1, \quad (25)$$

or again with elimination of S,

$$ik_1(\tan ik_2 + \cot ik_2) = k_2(\tan k_1 + \cot k_1),$$

whence

$$k_1 \sin 2k_1 + ik_2 \sin 2ik_2 = 0, \quad \quad (26)$$

or in the notation of the hyperbolic sine

$$k_1 \sin 2k_1 = k_2 \sinh 2k_2. \quad \quad (27)$$

If this equation, independent of σ , σ' , and $\cos \theta$, can be satisfied, it allows us to find k_1 from an assumed k_2 , or conversely, and thence k by means of (9).

The next step is to calculate S by means of one of equations (25). If S, so found, $> \cos \theta$, we may choose σ'/σ so that B shall vanish; but if $S < \cos \theta$, no ratio σ'/σ will serve to annul the reflexion. If the incidence be perpendicular, S must exceed unity. If S were negative, the reflexion would be finite, whatever may be the angle of incidence and the ratio σ'/σ .

It is natural to expect an evanescence of reflexion when the damping is small and the tuning such as to give good resonance. In this case we may suppose k_2 and $\pi - 2k^*$ to be small, and then (27) gives approximately

$$k_1 = \frac{\pi}{2} \left(1 - \frac{4k_2^2}{\pi^2} \right), \quad k = \sqrt{(k_1^2 - k_2^2)} = \frac{\pi}{2} \left(1 - \frac{6k_2^2}{\pi^2} \right). \quad (28)$$

By (25)

$$\begin{aligned} kS &= k_1 \tanh k_2 + k_2 \tan k_1, \\ &= k_1 \tanh k_2 + k_2 / \tan (2k_2^2/\pi), \\ &= \frac{\pi}{2k_2} (1 + k_2^2 + \dots), \end{aligned}$$

so that

$$S = k_2^{-1} \left\{ 1 + \left(1 + \frac{6}{\pi^2} \right) k_2^2 + \dots \right\}. \quad . . \quad (29)$$

Since S is large and positive, the condition for no reflexion can be satisfied by making the perforated area σ small enough.

For a more general discussion we may trace the curves

* So that wave-length is 4 times l_1 .

(B, A, fig. 1) representing the two members of (27), regarding k_1 and k_2 as abscissæ and taking as ordinates

$$y = k_1 \sin 2k_1, \quad y' = k_2 \sinh 2k_2. \quad \dots \quad (30)$$

Fig. 1.

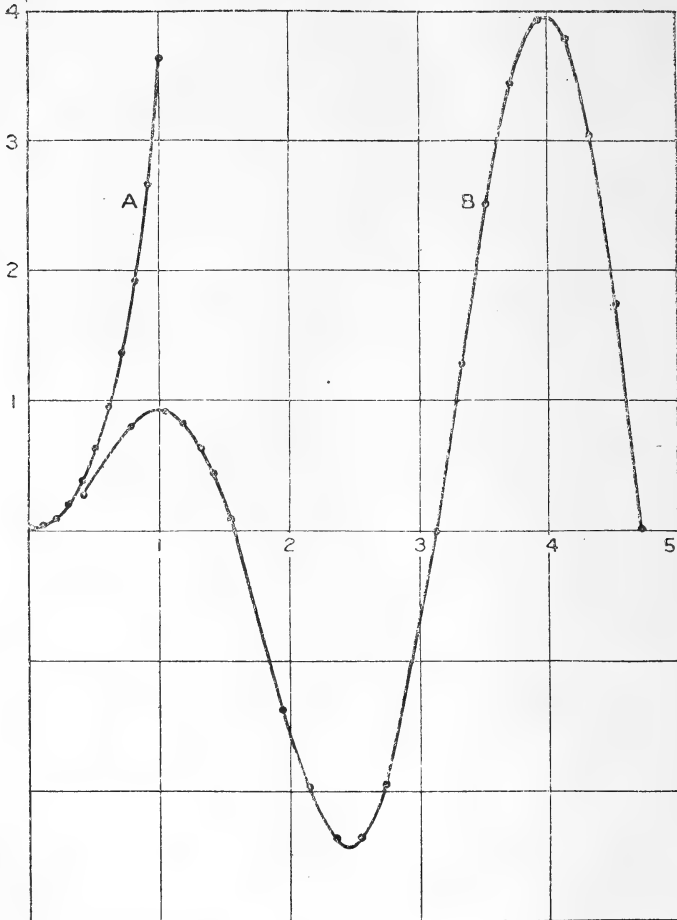

If k_1 and k_2 be both small,

$$y = 2k_1^2(1 - \frac{2}{3}k_1^2), \quad y' = 2k_2^2(1 + \frac{2}{3}k_2^2), \quad \dots \quad (31)$$

so that at the origin both curves touch the line of abscissæ and start with the same curvature. Subsequently $y' > y$ and increases with great rapidity. On the other hand, y vanishes whenever k_1 is a multiple of $\frac{1}{2}\pi$, although the successive loops

increase in amplitude in virtue of the factor k_1 . The solutions of (27) correspond, of course, to the equality of the ordinates y and y' . It is evident that there are no solutions when y is negative. The most important occur when k_2 is small and $2k_1$ just short of π . But to the same small values of k_2 correspond also values of $2k_1$ which fall just short of 3π , 5π , &c., or which just exceed 2π , 4π , &c. More approximately these are

$$2k_1 = m\pi + \frac{4 \cos m\pi \cdot k_2^2}{m\pi}, \quad \dots \quad (32)$$

where $m = 1, 2, 3$, &c.

In order to examine whether these solutions are really available, we must calculate S . By (25)

$$kS = k_2 \left(1 - \frac{1}{3}k_2^2\right) \left(\frac{m\pi}{2} + \frac{2 \cos m\pi \cdot k_2^2}{m\pi}\right) + k_2 \tan \left(\frac{m\pi}{2} + \frac{2 \cos m\pi \cdot k_2^2}{m\pi}\right).$$

If m is odd, we have approximately

$$kS = \frac{m\pi}{2k_2} (1 + k_2^2); \quad \dots \quad (33)$$

and if m is even,

$$kS = \frac{m\pi k_2}{2} \left\{1 + k_2^2 \left(\frac{8}{m^2\pi^2} - \frac{1}{3}\right)\right\}. \quad \dots \quad (34)$$

Since k is approximately $\frac{1}{2}m\pi$, we see that when m is odd, S is large, and the condition of no reflexion can be satisfied, as when $m = 1$. On the other hand, when m is even, S is small, and here also the condition of no reflexion can be satisfied, at any rate at high angles of incidence.

It should be remarked that high values of m , leading to high values of k , correspond with overtones of the resonating channels.

A glance at fig. 1 shows that there is no limitation upon the values of the positive quantities k_1 and k_2 . And since k_1 is always greater than k_2 , k , as derived from k_1 and k_2 , is always real and positive.

So far we have supposed that the values of k_1 , corresponding with small values of k_2 , are finite, as when $m = 1, 2, 3$, &c. But the figure shows that solutions of (27) may exist when k_1 , as well as k_2 , is small. In this case we obtain from (31)

$$k_1^2 = k_2^2 \left(1 + \frac{4}{3}k_2^2\right), \quad \dots \quad (35)$$

making

$$k^2 = k_1^2 - k_2^2 = \frac{4}{3}k_2^4. \quad \dots \quad (36)$$

Hence by (24)

$$kS = k_1 \tanh k_2 + k_2 \tan k_1 = 2k_2^2 (1 + \frac{2}{3}k_2^2), \quad (37)$$

and
$$S = \sqrt{3} \cdot (1 + \frac{2}{3}k_2^2). \quad (38)$$

Here again the condition of no reflexion can be satisfied, whatever the angle (θ) of incidence, by a suitable choice of σ'/σ . But the damping is no longer small, in spite of the smallness of k_2 , since k_2 is not now small *in comparison with* k_1 and k . On the contrary, k_1 and k_2 are nearly equal, and B is small in comparison with k_2 , so that this case stands apart.

Not only is it always possible to find a series of values of k_1 satisfying (27) with any assumed value of k_2 , but the values so obtained make S positive. For in (25) $k_1, k_2, \tanh k_2$ are positive, and so also is $\tan k_1$, since

$$\tan k_1 = \sin 2k_1 / 2 \cos^2 k_1,$$

and $\sin 2k_1$ is positive.

It is a question of some importance to consider whether when σ, σ' , and θ , determining S, are given, the reflexion can always be annulled by a suitable choice of k_1 and k_2 . It appears that the answer is in the affirmative. Let us consider the various loops of fig. 1 which give possible values of k_2 . The ranges for $2k_1$ are from 0 to π , from 2π to 3π , from 4π to 5π , and so on. As we have seen, the intermediate ranges are excluded. In the first range between 0 and π we found that S may be made as great as we please by a sufficiently close approach to π . At the other end where $k_1=0$, the value of S was $\sqrt{3}$, or 1.7320. This is the smallest value which occurs. When $2k_1 = \frac{1}{2}\pi$, it appears that $k_2 = .5656, k = .5449$, and $S = 1.947$. And again, when $2k_1 = \frac{3}{4}\pi, k_2 = .5795, S = 1.964$. We conclude that within this range some value of k_1 with its accompanying k_2 can be found which shall annul the reflexion, provided S exceed 1.7320, but not otherwise.

In each of the other admissible ranges, S takes all positive values from 0 to ∞ . At the beginning of a range when $2k_1$ slightly exceeds $2\pi, 4\pi, \&c.$, S starts from 0, as appears from (34); and at the end of a range, as $3\pi, 5\pi, \&c.$ are approached, S is very great (33). Within each of these ranges it is possible to annul the reflexion by a suitable choice of k_1, k_2 , whatever σ, σ' , and θ may be.

If the actual value of S differs from that calculated, the reflexion is finite, and we may ask what it then becomes. If we denote the value of S, as calculated from k_1, k_2 , by S_0 , (24) gives

$$\text{Mod.}^2 \text{ Numerator} = k^2(S - S_0)^2 \{1 + \tan^2 k_1 \tanh^2 k_2\},$$

and in like manner (by changing the sign of S),

$$\text{Mod.}^2 \text{ Denominator} = k^2(S + S_0)^2 \{1 + \tan^2 k_1 \tanh^2 k_2\};$$

and hence

$$\text{Mod.}^2 B = \left(\frac{S - S_0}{S + S_0} \right)^2, \quad \dots \dots \dots (39)$$

where

$$S = \cos \theta (\sigma + \sigma') / \sigma. \quad \dots \dots \dots (21)$$

If σ , the perforated area, is relatively great, it makes little difference what its actual value may be, but if σ is relatively small, as in the case of strong resonance, it is otherwise.

It would be preferable to suppose S fixed at S_0 and to calculate the effect of a variation of k with h given. The resulting expressions are, however, rather complicated, and it is evident without calculation that the reflexion will be very sensitive to changes of wave-length when there is high resonance as a consequence of small dissipation and accurate tuning. The spectrum of the reflected light [in the corresponding optical circumstances] would then show a narrow black band.

XXII. The Quantum Theory of Electric Discharge.

By Dr. D. N. MALLIK and Prof. A. B. DAS, M.Sc.*

1. **O**N the quantum theory, the energy of a source of radiation varies in a discontinuous manner by equal quanta. If this is to be accepted, since electrons give out radiation when their velocity is changed, the quantum theory would seem to suggest that these changes are effected by a series of jerks, that is in other words the changes involved are due to impulses only. Moreover, since a material atom is known to be made up of corpuscles and positive ions, having configurations satisfying conditions of dynamical stability, under their mutual attractions and repulsions, it is necessary to admit that they are revolving doublets or higher complexities. In view of their rapid movements and collisions, such systems must be admitted to have complex nutational motions as well. It stands to reason therefore, that the energy of such a system cannot be a continuously varying quantity. It must either remain constant or, if it changes at all, it must change by finite

* Communicated by the Authors. Paper read before the All India Science Congress, 1919, Bombay.

amounts, in view of the fact that the changes are effected by (generalized) impulses. In any case a variation of energy in a discontinuous manner is consistent with many well-known phenomena.

In the present paper we have attempted to interpret the behaviour of electric discharge in a vacuum-tube in terms of this theory.

2. In a vacuum-tube, as we know, the discharge is non-luminous or silent unless the difference of potential is greater than a certain amount, so that there is a minimum difference of potential for the passage of a spark.

Now assuming the formula

$$E_0 = \sum \frac{ch}{\lambda} \frac{1}{e^{\frac{Nch}{R\lambda}} - 1},$$

where c = velocity of light,
 λ = wave-length,
 h = Planck's constant,
 N = Avogadro's number,
 $R = \frac{pv}{T}$ for a gas,

and E_0 is the energy required for electronic oscillation of wave-length $\Sigma\lambda$, we observe that this quantity has a certain constant value, depending only on the nature of the gas. In other words, so long as a gas retains its specific properties, so as to yield a characteristic spectrum, the total energy required for luminosity has a constant value. That is, the energy corresponding to the ionization of the gas when attended with luminosity has a value which is constant and independent of the pressure of the luminous gas, so long at any rate as the gas continues to yield its characteristic spectrum.

3. If, then, E is the energy of a corpuscle which is in a condition to ionize, γE will be the energy that will be transferred to the ionized gas, where γ is a proper fraction. And for luminosity, γE must be equal to E_0 . It seems reasonable to suppose, therefore, that the minimum energy of the ionizing corpuscle must be E_0 . And if we further admit that E is proportional to spark-potential or at any rate of the form $a + bV$, where V is the spark potential, the minimum spark potential V_0 must be proportional to E_0 .

or of the form $a + bE_0$. The minimum spark potential must be then independent of the pressure. This has been found to be the case.

4. Now, it is well known that as the pressure of the gas decreases, a dark space is formed next to the cathode called the Crookes dark space. And it is obvious that until the energy of the ionizing corpuscle attains to the minimum value required, it will not be in a condition to ionize. This explains the formation of the Crookes dark space, and further suggests that the difference of potential between the cathode and the negative glow, called the cathode-fall of potential, must be approximately equal to the minimum spark potential and independent of pressure. This is also in accordance with known experimental results.

As the electric intensity in the Crookes dark space is very high, it will follow that the breadth of this space will be very small, increasing as the electric intensity decreases with pressure. It is seen further that the cathode-fall of potential must be proportional to E_0 , or at any rate be of the form $a_1 + b_1E_0$.

5. Again, the energy of a corpuscle when it collides with a molecule of the gas is evidently proportional to Xel , where X is the electric intensity and l the mean free path. Hence $Xel = E$. Moreover, it can be shown that if α is the coefficient which determines the rate of increase in the number of corpuscles, then, when α is equal to zero, Xel is constant. We find now that this constant value must be $= E_0$. Since, further, $l \propto \frac{1}{p}$ where p is the pressure, we find that when α is zero, $\frac{X}{p} = \text{const.}$, a result which was obtained otherwise in a previous paper (Phil. Mag. Oct. 1912).

6. Returning now to the Crookes dark space, we observe that it is limited by the point at which, through the action of the electric force, the energy $= E_0$, and, accordingly, this also marks the beginning of the negative glow. As the corpuscle moves through the negative glow, its energy decreases on account of collision, according to the law given (as J. J. Thomson has shown) by $E^2 = E_0^2 - 2\beta x$ or $E = E_0 \left(1 - \frac{\beta}{E_0^2} x\right)$ nearly, where x is the (small) distance

traversed and β is a function of the masses of the colliding ions. It will happen, therefore, that if X is the electric force, $E = E_0 - \frac{\beta x}{E_0^2} + \int X dx$, so that ionization will no longer be possible, when $\int X dx < \frac{\beta}{E_0^2} x$. This will then mark the beginning of the next or Faraday dark space.

7. Now, the energy at the extremity of the negative glow is evidently of the form $E_0 - kx$, where k may be taken to be constant as a first approximation. It is, moreover, known that x increases as pressure decreases. Assuming that $x \propto \left(\frac{A}{p} + B\right)$, this energy may be written equal to $E_0 - \frac{k_1}{p} - k_2$. If further, X_1 is the average electric intensity through the Faraday dark space and d is the length of this space, we must have $E_0 - \frac{k_1}{p} - k_2 + X_1 d = E_0$.

We have moreover $X_1 \propto \frac{1}{p}$ and $d = a' + \frac{b'}{p}$, approximately, during a certain range of pressure. We have thus, on this theory, a means of coordinating the various quantities associated with the cathode dark space, the negative glow, and the Faraday dark space.

8. Experiments show, however, that the linear law both as regards the negative glow and the Faraday dark space holds only for a limited range.

Obs. In both these experiments, the distance between the electrodes was 14.6 cm.

Experiment I.—Voltage in the primary about 11 volts.

(Curve I.)

Pressure in mm.	Scale-reading corresponding to the cathode terminal.	Scale-reading corre- sponding to the beginning of the positive column.	Length of the dark space.
27	14.9	14.7	.2 cm.
15	14.9	14.15	.75 "
5	14.9	13.48	1.42 "
3	14.9	13.25	1.65 "
1.5	14.9	11.75	3.15 "

After this stage, the cathode glow spreads up to the positive column and gradually overlaps it, practically the whole tube being illuminated.

Experiment II.—Voltage in the primary a little above 12 volts. (Curve II.)

(Illumination stronger than in the previous case.)

35	14.9	14.65	.25 cm.
17	14.9	14.3	.6 "
7	14.9	13.85	1.05 "
5	14.9	13.4	} 1.5 "
2	14.9	13.45	

As the pressure is further reduced, the cathode glow appears to extend up to the positive column and overlap it.

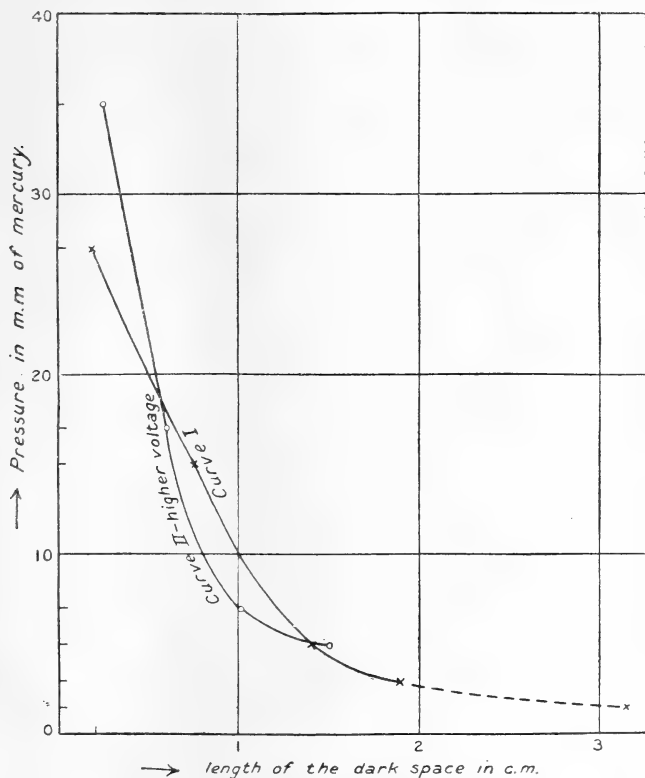

9. Again, with an induction coil, the line of demarcation between the Faraday dark space and the positive column is never well defined nor steady. This is in accordance with theory, for owing to a rapid variation in the potential of the induction coil, the energy of the field must vary in a rapid manner.

10. The peculiar behaviour of the striæ indicates that they are similar in character to the Faraday dark space and are of similar origin. On the Quantum theory, accordingly, they are regions over which the energy of discharge is less than E_0 . At very low pressure, before the disappearance of the striæ, both the Faraday dark space and the striæ continue to retain their breadth, showing that the corresponding change of energy is negligible.

XXIII. *Latent Heat and Surface Energy.*

To the Editors of the Philosophical Magazine.

GENTLEMEN,—

IN a recent number of the *Phil. Mag.* (vol. xxxviii. p. 240), there appeared an interesting paper by D. L. Hammick on a relation between the surface tension (γ), the internal latent heat (L_i), the molecular diameter (σ), and the molecular volume (V). For argon, the data used were as follows:—

$$\gamma = 11.00 \text{ dynes/cm. at } T = 87^\circ \text{ abs., } L_i = 1284 \text{ cal.,}$$

$$\sigma = 3.21 \times 10^{-8} \text{ cm., } d = M/V = 1.404,$$

whence

$$\frac{\gamma V}{\sigma} \cdot \frac{1}{J} = 226, \quad \frac{L_i}{6} = 214,$$

the agreement between these two numbers being considered good.

It does not appear to be generally known that the values of γ for liquid argon given by Baly and Donnan (*Journ. Chem. Soc.* lxxx. p. 907 (1902)) are incorrect. The correct

values are as follows (cf. Rudorf, *Ann. d. Physik*, xxix. p. 751 (1909)) :—

T	84	85	86	87	88	89	90	
γ	13.45	13.19	12.93	12.68	12.42	12.17	11.91	

As regards σ , the best values for the monatomic gases are, undoubtedly, those of S. Chapman (*Phil. Trans.* ccxvi. p. 279 (1916)), who found for argon $\sigma = 2.84 \times 10^{-8}$ cm. Using these corrected values for γ and σ

$$\frac{\gamma V}{\sigma} \cdot \frac{1}{J} = 302 \text{ cal.}$$

On the other hand, L_i is almost certainly more than 1284 (cf. Nernst, *Ztschr. f. Elektrochem.* xxii. p. 185 (1916)) and approximately 1440, whence $\frac{L_i}{6} = 240$. The agreement between 302 and 240 can hardly be considered good.

Yours faithfully,

G. RUDORF.

52 Cranley Gardens,
Muswell Hill, N. 10.
5. 11. 19.

XXIV. Notices respecting New Books.

The Earth's Axes and Triangulation. By J. DE GRAAF HUNTER, M.A., Mathematical Adviser to the Survey of India. (Survey of India Professional Paper No. 16.) Pp. viii + 219, with 6 charts. [Printed at the Office of the Trigonometrical Survey: Dehra Dun, 1918. Price Rs. 4 or 5s. 4d.]

THE first triangulation series of the Survey of India was commenced as long ago as 1831. At that time, the best values for the lengths of the axes and for the ellipticity of the earth were those derived by Everest. Consequently the observations were reduced using Everest's data as a basis, and in order to avoid discontinuities, subsequent triangulation series have been reduced using the same data, although it has for long been known that Everest's values are substantially in error. Moreover, the values used for the latitude and azimuth of Kalianpur, the origin of the survey, have also been found to be in error owing to a considerable local deflexion of the plumb-line. The necessity for freeing the results from the errors due to these incorrect data has become more and more pressing. To recompute the whole triangulation was of course entirely out of the question; the labour involved would

have been too enormous. The natural thing to attempt was to determine differential corrections to the coordinates of each point. This is the problem which Mr. Hunter has attempted and successfully solved, and the volume under review contains the results of his labours which have extended over several years, together with much other interesting matter arising directly out of, or suggested by, this research.

The problem is not such an easy one as it might appear. The complication arises from the fact that the observations have been *adjusted* to fit the Everest Spheroid, and consequently will not fit any other spheroid without *readjustment*. As a result of this, the corrections obtained for the coordinates of any point depend upon the route by which that point is reached from the origin. Various routes are discussed in the memoir, and after a detailed discussion it is concluded that, in view of the methods by which the observations of the triangulation in India have been reduced, the method of calculation along geodesics through the origin is the correct one to use. The discussion is of considerable theoretical importance and the conclusion arrived at appears to be justified.

In the latter part of the volume the general questions of the adjustment of a triangulation and of its "strength" are discussed. A criterion of the strength of a triangulation is determined which is superior to General Ferrero's in that it takes account of the length of the sides and the general formation of the series. This quantity enables probable errors of length of side and azimuth and also of latitude and longitude of any point of the triangulation to be expressed. Numerical values of the strength of all the Indian series of triangulation are given. The more difficult question of the assignment of probable errors after adjustment is considered in some detail.

An interesting by-product of the investigation is a pretty method for the solution of a large number of normal equations in the particular case when the equations can be divided into groups in each of which certain of the variables have zero coefficients. A well-ordered method of solution is illustrated in detail by a numerical example.

The volume embodies the results of a long and laborious research, and the results obtained are of the greatest practical importance. The author and the Survey of India are to be congratulated upon it.

H. S. J.

THE
LONDON, EDINBURGH, AND DUBLIN
PHILOSOPHICAL MAGAZINE
AND
JOURNAL OF SCIENCE.

MAR 15 1920 [SIXTH SERIES.]

MARCH 1920.

XXV. *On the Excitation of the Spectra of Carbon, Titanium, and Vanadium by Thermelectronic Currents. With special Reference to the Cause of Emission of Light Radiations by Luminous Vapours in the Carbon Tube Resistance Furnace.* By G. A. HEMSALECH*.

[Plates II.-V.]

CONTENTS.

- § 1. Introduction.
- § 2. Experimental methods.
- § 3. Temperatures of graphite plate for various potential gradients of heating current.
- § 4. Luminous phenomena observed in the vicinity of an electrically heated plate of graphite. Bluish vapour and red fringe.
- § 5. Influence of a transverse magnetic field upon the visibility of the red fringe.
- § 6. Origin of the red fringe. Thermelectronic current.
- § 7. Spectroscopic analysis of the red fringe and luminous vapours.
- § 8. Cause of the sharp outline shown by the red fringe and of the abrupt cessation of its spectrum emission.
- § 9. Displacements of red fringe emission by transverse magnetic fields.
- § 10. Possible cause of excitation of red fringe spectrum.
- § 11. Discussion of results and their application to the case of the electric tube resistance furnace.
- § 12. Probable cause of disagreement between Dr. King's results and mine.
- § 13. Summary of results.
- § 14. Concluding remarks.

* Communicated by the Author.

Phil. Mag. S. 6. Vol. 39. No. 231. March 1920.

R

§ 1. *Introduction.*

BY directly comparing the spectra of iron as emitted by flames of different temperatures with those given by an electric carbon tube-resistance furnace heated to corresponding temperatures, I arrived at the conclusion that the electric furnace gives out two different kinds of emissions caused by two separate and distinct modes of excitation. The spectrum of one of these emissions was found to be identical, at all temperatures up to 2500° C., with that observed in the mantles of various flames, being indeed composed of class I. and II. lines only. The spectrum of the second emission, which was observed in the furnace at temperatures of over 2500° C., showed in addition also class III. lines, the group at $\lambda 4957$ being particularly prominent. A special feature of the high temperature furnace emission was the prominent appearance of the Swan spectrum of carbon*. As a result of further observations and experiments I was led to attribute the cause of excitation of the first emission, which as I had shown is controlled by the temperature prevailing in flames and in the furnace, to the action of heat upon a chemical compound of iron (thermo-chemical excitation), and that of the second emission to the passage of an electric current through iron vapour, ionized to a considerable degree by the high temperature prevailing in the tube-furnace (thermo-electrical excitation). To this latter mode of excitation I also ascribed the emission of the Swan spectrum of carbon.

In the high temperature tube-resistance furnace the spectra of these two emissions are naturally always observed simultaneously and superposed upon each other; hence no direct evidence for the electrical origin of, for example, the carbon bands could be obtained, although the Swan spectrum was not observed by means of a special plate-furnace in which the electric field had been considerably reduced in intensity. As is well known, observations have to be made along the axis of the furnace tube and, since these tubes are generally of appreciable length, it is practically impossible to see what is going on in the immediate vicinity of the inner wall, from which the ionization currents are supposed to be passing out into the enclosed space filled with conducting vapours. If, however, we imagine a furnace tube with its jacket of carborundum powder, to be cut open longitudinally and rolled out flat, so as to constitute a plate protected from loss of

* Hemsalech, Phil. Mag. vol. xxxvi. p. 209; *ibid.* p. 281 (1918).

heat only on the top surface, we should be enabled to examine in a convenient manner the luminous effects produced by the ionization currents which always circulate in the immediate vicinity of an electrically heated carbon conductor—in this particular case, along the undersurface of the plate. Experiments carried out in this way have completely confirmed the results of my previous investigation with reference to the existence of the two emissions, and the unquestionably electrical origin of one of them, to which is due the spectrum of carbon, has been demonstrated beyond doubt by the action upon it of a transverse magnetic field. The evidence derived from these experiments indicates further that the particular ionization current, which produces the effect in question, is distinct from Professor Richardson's thermionic current and is most probably constituted of a stream of electrified particles of very small mass. I propose to call this current the *thermoelectronic current* in order to mark its distinguishing character from the former. This distinction appears to me justified, not only by reason of the very remarkable and definite spectroscopic effects produced, but also on account of the most significant influence which feeble magnetic fields exert upon the path of the thermoelectronic current. As will be shown in a subsequent communication, the passage of thermoelectronic currents through ionized vapours in a direction at right angles to the lines of force of a uniform magnetic field is accompanied by the formation of most beautifully defined luminous path figures of spiral and helical shapes. Furthermore, the cycloidal and trochoidal forms of projection of these paths upon a plane normal to the magnetic force, as foreseen by the electron theory, are clearly brought out.

As I have suggested in a preceding paper*, the high temperature furnace spectrum of iron may be regarded as a low tension arc spectrum, and it seems to me probable that the value of the electric field provided by a tube-furnace is about the minimum at which the atomic vibrations will be excited by electric action, at these high temperatures. In order to investigate the effects of stronger electric fields on the spectrum emission of luminous vapours several types of plate-furnaces have been evolved, which bridge the long gap between the tube-furnace conditions and those prevailing in the ordinary electric arc. Besides yielding most important results with regard to the relative sensitiveness of spectrum lines to thermo-electrical excitation, these plate-furnaces

* Hemsalech, *loc. cit.* p. 211.

have incidentally brought out some very interesting particulars concerning the formation of the electric arc which point to the existence of a critical temperature of the electrodes for a given strength of electric field.

The present paper will deal only with the luminous and spectroscopic effects which are caused by the passage of thermelectronic currents through the vapours in the vicinity of a single plate of graphite.

The experiments involved in the whole of this investigation have occupied the greater part of my time during the past two years, and I take this opportunity of placing on record my deep sense of gratitude to the Council of the Royal Society and to the Committee of the Privy Council for Scientific and Industrial Research, who by their generous financial assistance have rendered these researches possible.

I have also much pleasure in expressing my heartiest thanks to Sir Ernest Rutherford for the very cordial hospitality which he has extended to me in his laboratory and for the facilities of all kinds which he has most kindly placed in my way for carrying out these experiments.

§ 2. *Experimental Methods.*

When planning the experiments for these extensive researches special attention was paid, from the outset, to arranging them upon such a scale as to render their execution both possible and convenient for unassisted working. This applied in particular to the size of graphite plates to be adopted. Since several hundreds of experiments were necessitated in the course of this investigation, the use of large-sized plates, involving the running of heavy machinery for producing the necessary heating current, would have entailed considerable expense, both in material and labour, not to mention the high consumption of electrical energy. Accordingly a long series of trials was first made with graphite plates of various dimensions and, as a result of this preliminary work, a plate of small size was finally adopted which could be raised to the requisite maximum temperature by relatively feeble currents, such as can safely be taken for a short time from an ordinary battery of accumulators. One great advantage of small scale experiments is that their repetition or extension in other laboratories is greatly facilitated.

The plates used in these experiments are made of Acheson graphite. They are 10.0 mm. wide, 0.95 mm. thick, and about 37 mm. long. Their ohmic resistance at ordinary

room temperature is on the average $0.0214 \frac{\text{ohm}}{\text{cm}}$. They must be free from flaws, and it is further most essential that the two faces be as nearly as possible plane and parallel to each other, no deviation of more than 0.01 mm. being admissible. Any appreciable deviation in thickness will, especially at the higher temperatures, reveal itself immediately by the plates burning through instantly at the weak place.

The plates are either mounted in a special furnace arrangement to be described in a later paper, or simply clamped between bars of graphite in the following way:—two rectangular pieces of graphite A and B (fig. 1) from 7 to 8 in. long, $2\frac{1}{4}$ in. wide by 1 in. thick, are cut down at one extremity

Fig. 1.

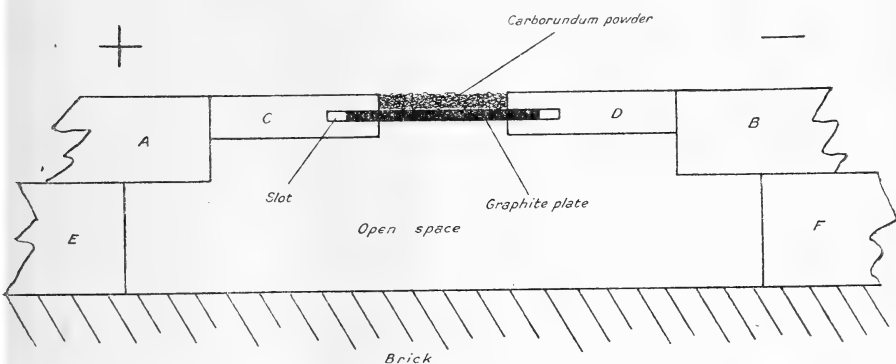

Method of mounting graphite plates.

in such a way as to leave protruding, level with the upper surfaces, circular rods C and D of $\frac{1}{2}$ in. diameter and 2.5 in. in length. The free ends of these rods are provided with horizontal slots, 0.5 in. long, into which the extremities of the thin graphite plates fit tightly. The object of these long rods is to reduce the loss of heat due to conduction, which becomes very serious when the heated plates are in direct contact with the voluminous bars A and B. These bars communicate through an ammeter and an adjustable resistance with a battery of accumulators. A voltmeter, by means of which the drop of potential along the plates can be ascertained, is shunted across A and B. In order to provide the necessary space below the heated plate for the full development of the luminous phenomena, the bars A and B are laid upon wooden blocks E and F, and the whole apparatus is supported by a brick. The graphite plates to

be heated are generally clamped in such a way as to leave an effective length of from 26 to 28 mm. between the ends of the clamping rods. The upper surface of the plate is then covered with a $\frac{1}{8}$ in. thick layer of carborundum powder, in order to reduce the great loss of heat which would otherwise result through unrestricted radiation and convection. With a heating current of about 250 amperes the temperature of the graphite plate, mounted in this way, exceeds 3000° C.

When interpreting the luminous effects observed beneath the plate, account must be taken of the possible action of air draughts which are occasioned by convection currents rising up from the hot plate. These currents cause air to be drawn up from below and to rise upwards in two wide streams, one on each side of the hot plate. Since the plate represents a flat obstacle, a certain quantity of apparently stagnant gas or vapour will be held in equilibrium between the plate and the rising air currents. Hence, the under-surface of the plate is protected from direct contact with air and it is, therefore, in its vicinity that the luminous phenomena, to be described in this paper, occur.

As was already suggested in § 1, such a plate may be regarded as equivalent to a tube cut open longitudinally and rolled out flat. But, whereas in a tube the ionization of the enclosed vapours and gases is easily accomplished, thanks to the complete protection from cold air, in the case of the exposed plate, on the other hand, a high degree of ionization, even in the immediate vicinity of the undersurface, is naturally much more difficult to attain. Hence, in order to produce effects similar to those observed in a tube-furnace, the temperature of the plate must be higher than that of the former, so as to make good the very rapid loss of heat by radiation. Now, this can only be accomplished by forcing heating currents of great density through the plate—an operation which inevitably entails the application of much higher potentials than are required in order to bring the tube-furnace to corresponding temperatures. Thus, for a temperature of 2700° C., the drop of potential along the plate is about $5.8 \frac{\text{volts}}{\text{cm.}}$, as against about $1 \frac{\text{volt}}{\text{cm.}}$ with the tube-furnace.

As is to be expected, the life of such a thin plate of graphite, raised to a high temperature, is a very short one. At the lower temperatures they will last 30 seconds and longer, but only from 6 to 10 seconds at about 3000° C. The phenomena to be examined are, however, so luminous,

that not more than 4 seconds are needed for securing a well-developed spectrographic record at 3000° C.

All experiments were made in air at atmospheric pressure, and a fresh plate of graphite was used for every observation.

§ 3. *Temperatures of graphite plates for various potential gradients of heating current.*

Temperature determinations were made by means of a Wanner pyrometer. In one series of readings—Nos. 1–12, the instrument was directed upon the underside of the heated plate at an angle of about 45°, the slit being about 7 cm. from the plate. In another series—Nos. 13–34, the graphite plate was fixed in the space between the coreless field coils of a Faraday electromagnet and the hot surface was sighted through one of the coils. The distance between plate and pyrometer was in this case about 16 cm. A new plate of graphite was of course used for each reading and the effective length of the plates was kept as nearly as possible at 27.5 mm. throughout. A voltmeter reading was taken in each case, but an ammeter reading only for Nos. 13–34.

On account of the short life of the plates, especially at the higher temperatures, and also in view of the fact that the resistance of the plates increases very rapidly after a heavy current has been passing through them for only a few seconds, all the necessary manipulations, settings, and readings, involved in the operation of determining the plate temperature, had to be accomplished within 10 to 15 seconds. The procedure adopted was generally as follows: by means of the adjustable resistance the current was at first raised slowly until the plate had become hot enough to be observed through the pyrometer, previously set for a low temperature. The current was now brought rapidly to the desired value, whilst at the same time the pyrometer was manipulated and adjusted in keeping with the rise in temperature. As soon as a steady state was reached (as indicated by the voltmeter) and the pyrometer finally set, a voltmeter reading was taken. The pyrometer was read only after the end of the experiment. When the determination of the plate temperature was made in a magnetic field the latter was put on first, and remained on throughout the experiment. The strength of the magnetic field used was 590 c.g.s. units and readings were taken with the magnetic force acting both upwards and downwards upon the current passing through the plate.

The following table contains the results of all the observations made, even those which are obviously out. On the

whole these results appear fairly consistent, considering the great experimental difficulties with which these determinations were beset.

No.	Heating Current.	Drop of Potential along plate. <small>volts</small> cm.	Temperature.	Direction of Magnetic pull.
1	—	5·52	2620° C.	—
2	—	6·07	2800 "	—
3	—	5·35	2560 "	—
4	—	5·56	2620 "	—
5	—	5·54	2750 "	—
6	—	5·17	2480 "	—
7	—	5·06	2275 "	—
8	—	4·77	2260 "	—
9	—	5·09	2350 "	—
10	—	5·04	2480 "	—
11	—	4·52	2240 "	—
12	—	3·57	2020 "	—
13	170 amps.	4·91	2300 "	—
14	170 "	5·45	2480 "	down.
15	170 "	4·80	2400 "	up.
16	170 "	5·35	2610 "	—
17	165 "	5·28	2515 "	down.
18	170 "	4·73	2400 "	—
19	170 "	4·73	2520 "	up.
20	210 "	5·64	2780 "	—
21	210 "	5·64	2720 "	down.
22	210 "	5·64	2780 "	up.
23	250 "	8·0	2309 "	—
24	250 "	8·0	3200 "	—
25	260 "	7·28	2480 "	—
26	260 "	8·0	3300 "	—
27	125 "	3·64	1970 "	—
28	105 "	2·18	1690 "	—
29	105 "	2·36	1730 "	—
30	175 "	4·73	2310 "	—
31	145 "	4·18	2120 "	—
32	145 "	4·18	2090 "	—
33	125 "	3·27	1990 "	—
34	125 "	3·64	1910 "	—

With the help of these results the accompanying temperature curve has been constructed (fig. 2). This curve is approximately a straight line. Those points which were

obtained with the magnetic field on are specially marked— a completely shaded circle, when the magnetic force was

Fig. 2.

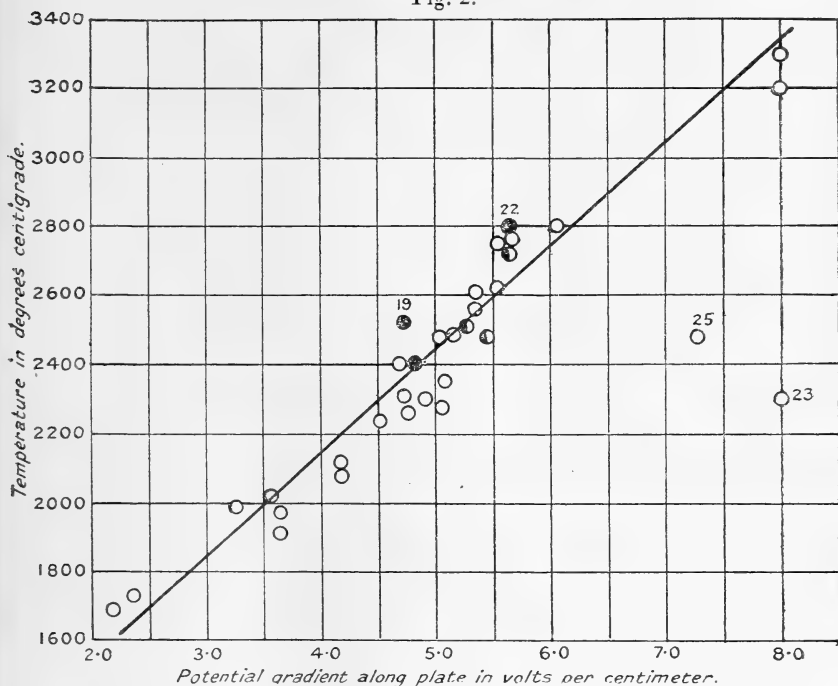

Temperature curve of graphite plate.

acting upwards, and a half-shaded circle, when the force acted downwards. There seems to be no definite effect due to the presence of the magnetic field, for although Nos. 19 and 22 lie rather much above the line and seem, if anything, to indicate a rise in temperature, when the magnetic force is acting upwards, they are yet too near the limits of possible errors to allow of any positive conclusion being derived. But the result, as it stands, is of the utmost importance for the interpretation of certain phenomena to be discussed in § 9.

A few additional temperature determinations were made with plates which were not protected by a layer of carborundum powder, so that their upper surfaces were left exposed and free to radiate heat. Under these conditions the temperature of the undersurface, with a potential gradient along the plate of $5.93 \frac{\text{volts}}{\text{cm.}}$, was found to be only 2450°C. —namely, about 250°C. less than when the plate

250 Mr. G. A. Hemsalech: *Excitation of Spectra of Carbon*,
was protected. The upper surface, which naturally loses
heat more rapidly, gave, with a potential drop of $5.63 \frac{\text{volts}}{\text{cm.}}$,
only about 2250° C. These figures emphasize the great
importance of the protecting layer of carborundum, and it
deserves to be mentioned that some of the most important
results achieved in the course of the present investigation
were directly due to this precaution.

§ 4. *Luminous phenomena observed in the vicinity of the
electrically heated plate of graphite.*

Observations were made by forming an image (about twice
actual size) of the heated plate upon a white cardboard screen.
This plan proved not only very convenient, but it also had
the further advantage over direct observation through dark
glasses, of showing the phenomena in their true natural
colours,—a most helpful adjunct for interpreting the meaning
of the luminous effects displayed.

As the temperature of the plate is gradually raised,
yellowish vapours begin to form along the undersurface
and a continuous stream of similar vapours is seen to rise
upwards from above the plate. At temperatures of from
 2300° to 2500° C., the coloration of the vapours beneath the
plate changes to bluish grey and, furthermore, they present
now a sharply-defined outline as sketched in fig. 3. In the
region above the plate, where the temperature is much lower,
the colour of the rising vapours continues yellow, with here
and there a greyish streamer or patch. In the neighbour-
hood of the plate, principally just above it, are also seen
red-coloured regions. All these colour effects are due, no
doubt, to the various light radiations emitted under the pre-
vailing temperature conditions, by the vapours driven out
from the graphite plate and the carborundum.

In order to account for the sharp demarcation of the
incandescent vapours beneath the plate two factors must be
taken into consideration—namely, the continuous effusion,
from the undersurface, of vapour which is being forced
downwards into the protected space, and the upward
draught of air, as explained in § 2. At the boundary sur-
face of the protected space the hot vapour comes into contact
with the air current, is cooled with consequent changes in
its radiating properties, and is then immediately carried
away upwards. Since it is reasonable to assume that, whilst
the temperature of the plate remains constant, both the
quantity of vapour passing through the protected space and

the velocity of the uprushing air will not vary appreciably, we may expect that some stable régime will become established in which there are no rapid variations in the position

Fig. 3.

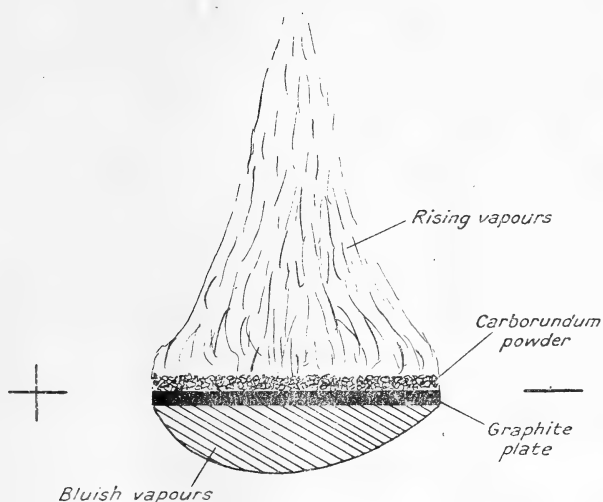

Plate temperature : 2300–2700° C.

of the boundary surface between the vapours and the surrounding air currents. The sharply defined outline of the bluish vapour might accordingly be caused by a steady state of the acting forces and by the continual clearing away of the superfluous vapours through the upward rush of air.

Although the existence of appreciable ionization currents through the luminous vapours, under these temperature conditions, was easily shown by means of a pair of exploring electrodes, the spectroscopic results did not, however, indicate that the light radiations emitted by these vapours were entirely governed by them. A most remarkable effect, both luminous and spectroscopic, was however observed when the graphite plate was raised to a temperature of about 3000° C. In immediate contact with the undersurface of the hot plate and suspended from it as it were, there appeared a sharply defined luminous band of pinkish hue, stretching right across the space between the clamping bars

252 Mr. G. A. Hemsalech: *Excitation of Spectra of Carbon*, and extending downwards to a distance of from 1 to 2 mm. (fig. 4). For convenience' sake, this luminous band will henceforth always be referred to simply as the *red fringe*, although there is a distinct violet shade in its colour.

Fig. 4.

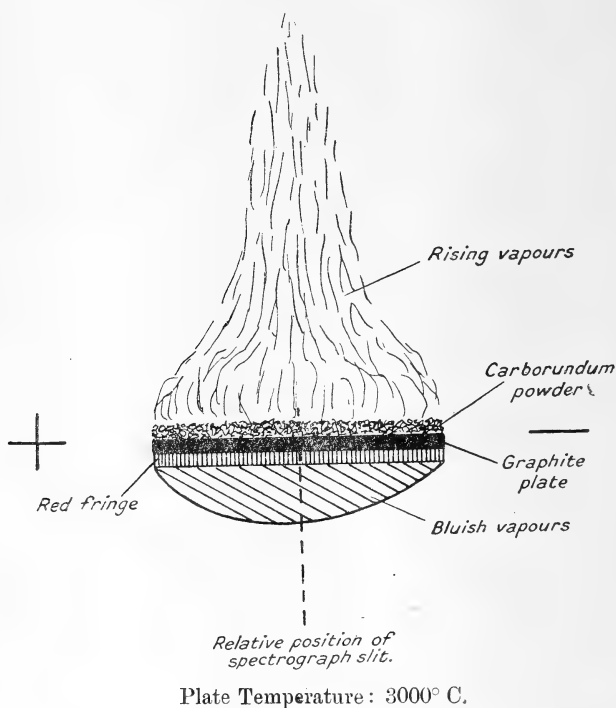

A preliminary examination of the spectrum of the red fringe, which was found to be entirely different both as to character and composition from that given by the luminous vapours situated beneath the fringe, at once suggested thermo-electrical excitation as the cause of its emission. It was therefore provisionally assumed as a working hypothesis that, owing to the very great degree of ionization prevailing at this high temperature, part of the heating current had passed out of the graphite plate into the space below and that its path was revealed by the formation of the red fringe.

§ 5. *Influence of a transverse magnetic field upon the visibility of the red fringe.*

If, as has been assumed, the red fringe were caused by the passage of an electric current outside the plate, it should be acted upon by a transverse magnetic field. In order to test this graphite plates were mounted between the hollow field coils of an electromagnet in such a way, that the heating current flowed at right angles to the direction of the lines of magnetic force. The temperature of the plate was raised to about 2700° C., at which stage the red fringe is ordinarily not yet visible. As soon, however, as a magnetic field of from 125 to 175 c.g.s. units was put on with the force acting upon the heating current in a downward sense, the red fringe immediately appeared. On taking the magnetic field off, the red fringe disappeared. On reversing the direction of the magnetic field, no red fringe was observed. One would have expected, in this latter case, to see a red fringe appear above the plate, but undoubtedly, owing to the prevailing convection currents, the vapours do not become sufficiently ionized under these temperature conditions to allow of the passage of an electric current. But when the plate was raised to a temperature of about 3000° C., so that the red fringe was well visible beneath the plate even without the aid of a magnetic field, then the application of an upward acting magnetic force of 1300 c.g.s. units brought out a red fringe above the plate, whereas the fringe beneath the plate practically disappeared. On taking the field off again the red fringe above disappeared, whereas at the same time that beneath the plate reappeared. By applying Fleming's hand-rule it was easy to show that the displacements of the red fringe were quite in accordance with the laws of electromagnetic induction, which is a direct proof that the red fringe is governed by the flow of an electric current. Furthermore, the appearance of the red fringe cannot be governed by temperature alone, for otherwise it would mean that when a magnetic field of from 125 to 175 units acts in the *downward* sense upon the plate at 2700° C. its temperature should increase by about 300° C., which, as the results of my temperature determination (§ 3) clearly show, is not the case.

But, in addition to these facts and arguments in favour of the electrical nature of the red fringe, a most important factor, which also gives strong support to this view, is the following observation made when the red fringe was acted upon by a transverse magnetic field in a downward sense:—luminous streamers were seen to pass out of the fringe into

the space below, forming bright and most sharply defined spiral or other paths, such as might be expected to result from the action of a magnetic field upon a stream of luminous particles carrying electric charges.

§ 6. *Origin of the red fringe.*

It may be useful, at this stage, to briefly inquire into the nature of the vehicles which convey the electric current in the red fringe. It is well known from the work of many physicists, in particular from Professor Richardson's extensive researches, that at temperatures much below that at which the red fringe is formed, electric currents are passing through the ionized vapours or gases in the neighbourhood of an electrically heated carbon rod or metal wire. It is generally assumed that these currents are caused by the displacement of ions under the influence of the acting electric field, and Professor Richardson has therefore proposed to call them thermionic currents. There is no doubt that the electric currents, which I was able to register between two exploring electrodes held in the luminous vapour beneath the heated plate, at the lower temperatures (see § 4) were of this nature. Now, these currents do not seem to have any appreciable influence upon the character of the spectra emitted by the vapours, which, as will be shown later, are practically identical with those given by these same vapours in the outer mantles of flames. But also in other respects the thermionic currents differ greatly from the current which causes the red fringe—namely in a transverse magnetic field they are much less acted upon than the latter. Whereas the red fringe is extremely sensitive to the magnetic force and a field of a very few units suffices to produce a distinct spiral or helical path, a field of at least 500 units is necessary to form an ill-defined and relatively undeveloped curved path in the luminous vapour with thermionic currents. It seems to me that this difference in behaviour between the thermionic current and that causing the red fringe might possibly be accounted for by assuming that the particles which convey the electric current are of different masses in the two cases. Thus, whereas the thermionic current is probably due to the motion of relatively heavy particles, in this case perhaps carbide molecules, the current in the red fringe would arise from the displacement of relatively light particles. These are perhaps constituted of free radiating atom-ions formed by the electrons which emerge in large quantities from the hot graphite plate, and the paths of which are under the control of the magnetic

field set up by the heating current, as explained in § 8. The origin of the red fringe emission would thus be, in some way, connected with the process of generation of these atom-ions. As it will be necessary, especially for spectroscopic purposes, to make a clear distinction between the thermionic current and that producing the red fringe, I propose to call the latter the *thermelectronic current*.

§ 7. *Spectroscopic analysis of red fringe and luminous vapours.*

A two-fold magnified image of the incandescent graphite plate and the luminous phenomena below it was accurately focussed on the slit of the spectrograph, already described in a previous communication*. The image was adjusted in such a way that the slit passed through the middle part of the plate and perpendicularly to it, as indicated by the dotted line on fig. 4. By this means the spectral changes occurring along the distance from the hottest part in the immediate vicinity of the plate, down to the region of complete extinction of the luminous vibrations, could be observed at a glance or recorded photographically. The times of exposure for the photographic records varied from 3 seconds at the highest to over half a minute at lower temperatures.

The spectrum of the vapours which form beneath the plate is of course due to the elements contained in the graphite and carborundum as impurities, probably in combination with carbon as carbides. At lower temperatures appear the lines of Na, K, Li, Sr, Ca, Mn, Al, and Fe, and the whole spectrum is observed to grow progressively in intensity and development as the plate temperature gradually rises. In addition to the line spectrum there is also seen a continuous spectrum which is particularly strong near the lower edge of the bluish vapour and extends to the same distance downward as the latter. Now, the lines emitted by the various impurities expelled from the graphite and carborundum generally pass well below the border of the continuous spectrum; this indicates that their emission centres travel to a greater distance from the plate than the bulk of the bluish vapour. Hence there appears to be no direct connexion between the line emission observed and the sharply bordered cloud of bluish vapour described in § 4. It is possible that the bluish vapour is formed only along the boundary surface of the protected space, constituting as it were a kind of envelope, and that the emission centres, to

* Hemsalech, *Phil. Mag.* vol. xxxiii. p. 7 (1917).

which are due the impurity lines observed under these conditions, are located within the enclosed space—namely, in the hot region extending down from the central part of the plate. In order to account for the greater extension downwards of the line emission as compared with the continuous emission due to the bluish vapour, we may suppose that the emission centres, which are probably constituted of charged particles (perhaps carbide molecules, see § 6), travel along lines of force under the action of the electric field established along the graphite plate by the passage of the heating current. As it will be of advantage for the sake of clearness to designate the particular vapour which gives out the line emission, as distinct from the bluish vapour, it will always be referred to as the *luminous vapour*.

With regard to the iron lines it will be shown hereafter that their relative development is in accordance with that, which I have previously observed for the same element in flames and in the tube-furnace. From this we may conclude that, also in the present case, their emission is caused by thermo-chemical excitation—namely, the action of heat on a chemical compound of iron, in this case probably a carbide.

A characteristic feature of all the lines emitted by the luminous vapour is that they die out gradually on passing downwards. This is, of course, to be expected, if these radiations are, as I presume, controlled by the plate temperature, for the latter naturally decreases with increase of distance from the plate. In this respect these lines behave very similarly to what they do in flames, in the mantles of which they are likewise observed to die out only gradually on passing into cooler regions.

When the plate temperature is raised to about 2700° C. a new spectrum begins to develop in the immediate vicinity of the graphite plate, with the appearance of the carbon* bands at 3883 and 4216 and of numerous lines due to titanium and vanadium. As the temperature is gradually increased this spectrum gains in prominence and more carbon bands appear in the visible part until nearly all the bands of the Swan spectrum are out. Finally, in the red part is seen a group of most intense, hazy, and broad bands, which when the spectrum is fully developed constitute its most brilliant feature. Now the very striking and distinguishing character of this spectrum is, that the lines

* Runge and Grotrian have recently concluded that these bands are due to nitrogen. As a result of my own experiments, which were likewise made at atmospheric pressure and of which I hope to give an account on a future occasion, I am unable to endorse their view. Nor do my experiments indicate that the presence of N is always essential for their emission.

and bands which compose it, unlike those emitted by the luminous vapours previously described, pass only a short distance down from the graphite plate and stop quite abruptly, as though the exciting agent had suddenly ceased to act. Evidently then, this spectrum cannot be entirely controlled by the plate temperature, as otherwise its lines and bands, like those of the luminous vapour emission, would die out only gradually. We must therefore trace its origin to some other cause, and it is only natural to connect the emission of this spectrum with the formation of the red fringe. A direct experimental proof for the reality of this connexion will be given in § 9. Thus, the emission of the carbon bands and of the lines of titanium and vanadium is in some way caused by the thermoelectronic current which, at these high temperatures, passes through the strongly ionized vapours in the immediate vicinity of the graphite plate. The emission would therefore be due to what I have previously called thermo-electrical excitation*, and it is no doubt of the same nature as that which I had preconceived to exist in a high temperature tube resistance-furnace.

The spectrum of the red fringe and of the luminous vapours are reproduced on Plate II. The narrow strip of sharply defined and strong continuous ground, which forms the upper edge of each section, is due to the luminous emission by the exposed edge of the incandescent graphite plate. The ultra-violet end *a* was obtained with the special furnace arrangement in which the vapours beneath the plate are better protected from air currents, and sections *b* and *c* with the clamping bars described in § 2. In this latter case the vapours are more exposed to air draughts and therefore the spectrum lines do not pass down quite so far. In the zone of the red fringe the two emissions are naturally seen in superposition, but by reason of the abrupt extinction of the lines and bands which compose the red fringe spectrum, the separate existence of each emission is clearly brought out. Some of the low temperature lines are seen in absorption upon the continuous spectrum due to the edge of the graphite plate. This is of course caused by the constant stream of excess vapour which is being carried upwards in front of the plate by the aforesaid air currents. It is also well to draw attention to the behaviour of the H and K lines of calcium. These lines are seen to pass down a much shorter distance from the plate than neighbouring iron lines of equal or even less intensity, such as the group at 3920. They are

* Hemsalech, *Phil. Mag.* xxxvi. p. 295 (1918).

therefore not emitted at so low a temperature as iron lines. This fact is indeed quite in harmony with M. de Watteville's and my observations regarding the flame spectra of these elements. In the mantle of the air-coal gas flame the iron lines are well developed, whereas no trace of H and K is seen. But the latter are quite intense in the oxy-coal gas flame at 2400° C. It would therefore seem that also in the present case the H and K radiations are caused principally by thermochemical excitation, and they do not appear to be appreciably affected by the thermoelectronic current.

The following tables contain all the lines and bands of the spectrum of the red fringe, but only those of the luminous vapour which were observed by me likewise in a carbon tube resistance-furnace. Lines to which an asterisk is affixed are marked on the plates to the nearest Ångström unit.

Titanium.

Relative intensities.				Relative intensities.			
λ .	Red fringe.	Arc.	Spark.	λ	Red fringe.	Arc.	Spark.
3635.47	000	15	3	4078.47	000	8	4
3642.68	000	15	3	4301.08	$\frac{2}{3}$	15	3
3653.49	00	15	4	4305.91	1	20	8
3671.66	000	4	3	4314.80	000	5	3
3689.89	000	3	2	4393.93	00	5	2
3717.39	000	5	2	4512.74	00	15	4
3729.77	1	8	4	4518.03	00	15	4
*3741.14	1	15	2	4522.80	00	15	4
*3752.87	1	15	5	4527.31	00	15	4
3753.63	00	3	3	45 ^{33.25}	1	20	5
*3771.64	$\frac{1}{2}$	4	3	34.78		15	4
3900.53	00	5	50	45 ^{35.92}	2	8	3
3904.77	0	10	5	36.00		20	4
3924.52	1	8	3	4544.70	0	10	3
3929.87	1	8	3	4548.77	00	8	3
3947.75	1	10	3	4656.47	0	8	3
3948.66	$1\frac{1}{2}$	12	4	4667.59	0	10	5
3956.28	$1\frac{1}{2}$	15	4	4681.91	0	20	10
3958.21	2	15	5	4991.08	1	20	10
3962.86	0	8	3	4999.51	1	20	10
3964.27	$\frac{1}{2}$	8	3	5007.22	$\frac{1}{2}$	20	10
*3981.77	1	15	3	*5014.26	1	20	8
3982.54	0	8	3	5039.96	$\frac{1}{2}$	10	3
*3989.77	2	20	6	5064.66	1	10	4
*3998.85	2	20	6	5173.74	0	15	5
*4009.14	$\frac{1}{2}$	8	4	5192.97	0	20	8
4009.68	000	4	2	*5210.39	$\frac{1}{2}$	20	10
*4024.57	$\frac{1}{2}$	10	3				

Wave-lengths are given in international units and the scale of intensities is that outlined in a former communication*.

Some lines situated in the bright tails of the carbon bands have probably escaped attention. The relative intensities in arc and spark were obtained from the observations of Exner and Haschek. A comparison of these results shows that the red fringe spectrum of titanium is composed of the brighter arc lines, and only one so-called enhanced line has been recorded—namely, λ 3900.53. As to the character and origin of this spectrum very little can at present be said or suggested, because the flame spectra of this element (chemical and thermo-chemical excitation) are as yet practically unknown. It is, however, of interest to mention that none of these lines were observed by me in an ordinary arc between electrodes made of the same kind of graphite; but they appeared near the cathode in heavy current arcs of from 20 to 80 amperes. No trace of them was observed in the ordinary condensed spark between graphite poles, but a few of the brighter ones were detected in the self-induction spark. It is therefore remarkable that they should constitute such an important part of the red fringe spectrum.

Vanadium.

λ .	Relative intensities.			λ .	Relative intensities.		
	Red fringe.	Arc.	Spark.		Red fringe.	Arc.	Spark.
3902.25	0	4	2	4128.10	$\frac{1}{2}$	10	10
4092.68	00	15	3	4131.98	$\frac{1}{2}$	10	10
4099.80	00	20	2	4134.47	000	10	10
4105.20	00	10	4	*4379.24	1	30 R	30 R
4109.78	000	15	10	4384.73	$\frac{1}{2}$	30	30 R
4111.80	$\frac{1}{2}$	30 R	2	4389.98	0	20	20 R
4115.17	00	5 R	2	*4408.50	$\frac{1}{2}$	10	15 R
4116.50	000	15	5	4586.37	00	10	8
4123.65	000	5	3	4594.09	00	10	10

This spectrum is likewise composed of the brighter arc lines only. It is of course possible and even probable, that some lines have been overlooked, as in the case of titanium; this is, however, inevitable on account of the presence of a strong continuous ground and of the carbon bands, which fact, coupled with the relatively low dispersion of my

* Hemsalech, *Phil. Mag.* vol. xxxiii. p. 9 (1917).

spectrograph, would naturally tend to mask or obliterate some of the lines.

Also in this case it is impossible to form an adequate opinion as to the true character of the spectrum emitted by vanadium, on account of the absolute lack of information with regard to its flame spectra.

Carbon.

Red edge of band.			
λ.	Relative Intensity.		
*3861·71	4	}	} So-called Cyanogen bands.
*3871·39	6		
*3883·40	10		
*4167·61	1	}	
*4180·82	$1\frac{1}{2}$		
*4197·08	2		
*4215·96	3		
4684·76	00	}	} Group IV.
4697·39	$\frac{1}{2}$		
4715·13	2		
*4737·00	3		
*5129·24	1	}	} Group III.
*5165·12	4		
5585·28	0	}	} Swan Spectrum.
*5635·21	1		

The spectrum is composed of the so-called cyanogen bands and three groups of the Swan bands. I have no doubt that group I. of the last-named bands—namely, that with head at λ 6188, would likewise show were it not for the presence, in this part of the spectrum, of one of the hazy broad red bands. A higher dispersion will probably reveal it. The bands at 3883 and 4216 are particularly intense and, next to the hazy red bands, they constitute the most prominent feature of the red fringe spectrum; also I feel inclined to attribute the violet tint in the red coloration of the fringe to the presence of these bands.

Although there is nothing noteworthy in the general aspect of the carbon bands as excited by the thermoelectronic current, it is however of prime importance to point out the marked fundamental difference which distinguishes this mode of their excitation from that which determines the emission of these bands in the explosion

regions of various hydrocarbon flames. As was already stated at the beginning of this paragraph, the first band to appear under red fringe conditions is 3883. As the intensity of thermo-electrical excitation increases, the various groups of bands appear in the order as given in the table—namely, first the so-called cyanogen bands and finally those of the Swan spectrum. Now this order of development of the carbon spectrum is reversed when chemical excitation is the cause of their emission. With the feebler chemical actions in the air-coal gas cone the Swan bands appear indeed alone, and it is only in the cone of the oxy-acetylene flame, where chemical actions of a very violent nature prevail, that the bands at 3883 and 4216 are likewise brought out. It is also well to mention the fact that the carbon bands are not emitted by the hottest parts of these flames—namely, the region in the mantle just above the cone; hence their emission cannot be caused solely by thermal or thermo-chemical actions, and this conclusion agrees well with the results of the present experiments.

Red bands of unknown origin.

λ.	Relative intensity.
6059	1
*6176	2
*6313	2
*6482	1

As these bands have no well-developed edges the settings were made upon their middles, as nearly as was possible to judge. The numbers representing their wave-lengths have therefore no pretence to accuracy.

To visual observation these bands constitute the most prominent and characteristic feature of the whole fringe spectrum. It is indeed to them that the peculiar red colour of the fringe owes its origin. In appearance these bands are extremely hazy, no edge or other structure being discernible; nor has it so far been possible to identify them with any known bands, although one of them—namely 618, falls very near a well-known calcium band. A higher dispersion will no doubt solve their mystery.

Luminous Vapour.

Element.	λ .	Class.	Relative intensities.	
			Luminous vapour (graphite plate).	Carbon tube- furnace (2400°).
Aluminium	*3944.03		10	6r
	*3961.54		12	8r
Calcium	*3933.67		2	00
	*3968.48		1	—
	*4226.72		20	15
	4289.36		2 blended with Cr.	—
	4298.98		1	—
	*4302.53		1½	1
	4318.64		1	00
	*4425.45		½	—
	*4435.32 d		2	1
	*4454.78		2	¾
Manganese	*4030.80		1	2
	4033.06		¾	1½
	4034.48		½	1
Potassium	*4044.15		3	4
	*4047.21		2	3
Strontium	*4607.34		3	6
Lead	3683.47		00	—
	*4057.84		1	1
Chromium	*4254.34		1	2
	*4274.80		¾	1½
	4289.72		2 blended with Ca.	1
Iron	3647.84	I.	000	—
	3679.92	I.	00	00
	3687.54 d	I.	00	000
	3705.56	I.	0	1
	3707.91	I.	00	00
	3709.24	I.	00	0
	*3719.93	I.	2	6r
	3722.57	I.	½	2
	3727.63	I.	0	½
	3733.32	I.	½	2
	3734.86	II.	1	3
	*3737.13	I.	1½	5r
	3743.37	II.	0	½
	*3745.73 d	I.	1½	4r
	3748.25	I.	¾	3
3749.47	II.	¾	2	

Element.	λ .	Class.	Relative intensities.	
			Luminous vapour (graphite plate).	Carbon tube- furnace (2400°).
Iron	3758·23	II.	1	2
	3763·80	II.	$\frac{3}{4}$	$1\frac{1}{2}$
	3767·19	II.	$\frac{1}{2}$	1
	3787·88	II.	0	$\frac{1}{2}$
	3795·00	II.	$\frac{1}{2}$	1
	3798·50	II.	$\frac{1}{2}$	1
	3799·55	II.	$\frac{1}{2}$	1
	3812·88	II.	—	1
	3815·84	II.	$\frac{3}{4}$	1
	*3820·44	II.	1	4
	3824·44	I.	$\frac{3}{4}$	3
	*3859·90	I.	2	6 r
	3865·53	II.	—	$\frac{1}{2}$
	3872·51	II.	—	1
	3878·02	II.	$\frac{1}{2}$	2
	3878·70 <i>d</i>	I.	1	2
	3886·29	I.	1	3
	3887·05	II.	—	1
	3988·52	II.	—	$\frac{1}{2}$
	3895·65	I.	1	2
	3899·70	I.	1	3
	3902·95	II.	—	$\frac{3}{4}$
	3906·47	I.	$\frac{1}{2}$	$1\frac{1}{2}$
	3917·17	II.	—	0
	*3920·26	I.	1	2
	3922·92	I.	$1\frac{1}{2}$	3
	3927·94	I.	$1\frac{1}{2}$	3
	3930·30	I.	$1\frac{1}{2}$	3
	3969·26	II.	—	1
	4005·26	II.	0	$\frac{1}{2}$
	4045·82	II.	1	2
	4063·61	II.	1	$1\frac{1}{2}$
	*4071·75	II.	1	1

Since a detailed description of the spectrum emitted by the luminous vapour is outside the scope of the present paper, only such data have been collected in the preceding table as were considered indispensable, both for showing the general character of the emission and for establishing the fact that it is of precisely the same type as that observed in a carbon tube resistance furnace. The data regarding the tube-furnace have been taken from an earlier communication * ; since they were obtained with the same spectrograph, they may be directly compared with the results of the present research: the only difference between the photographic

* Hemsalech, Phil. Mag. vol. xxxvi. pp. 218 & 224 (1918).

records secured in the two cases is that the furnace spectra were exposed for two minutes, whereas the spectra obtained with the graphite plate were given only six seconds, and therefore the relative intensities are generally on a slightly lower scale in the latter case. As regards iron, only the ultra-violet end of the spectrum has been given here, but the table contains all the lines observed in that region. Between 3824 and 3860 a few lines have not been recorded with the graphite plate, because the strong carbon band at 3883 rendered their observation difficult. Similarly, the line 4216 has not been observed, as it nearly coincides with the head of a band.

With regard to the temperature of the luminous vapour nothing definite can be stated, as no data are available concerning the temperature gradient on passing from the plate downwards. The surface temperature of the plate was nearly 3000° C. and the observations upon which the tabular results are founded refer to the region situated about one millimetre away from the radiating surface. If we compare these results with those given by the tube-furnace at 2400° C. and bear in mind the fact that the plate results were obtained with only $1/20$ the exposure of the furnace ones, we shall probably not be far wrong by assuming a temperature of at least 2700° C. for the luminous vapour at the distance of about one millimetre from the hot plate. It is interesting in this connexion to mention that under these conditions class III. group 4957 of iron was not observed.

The great similarity between the fundamental characters of the spectra, as given by the plate and the tube-furnace, is so striking that there can be no room for doubt as to the identity of the mode of excitation in the two cases. We are therefore justified in concluding that the luminous emission of the impurities which are expelled from the graphite and carborundum and carried some distance downwards from the plate, is caused by thermo-chemical excitation and is of the same nature as that observed for these same elements in the tube-furnace and in the mantles of various flames.

§ 8. *Cause of the sharp outline shown by the red fringe and of the abrupt cessation of its spectrum emission.*

Sir Ernest Rutherford has very kindly directed my attention to the probable influence of the magnetic field due to the heating current upon the motion of the electrons in the red fringe. This magnetic field would tend to drive the electrons back towards the plate and, consequently, to oppose

the formation of the red fringe. Sir Ernest has further been good enough to calculate the strength of the magnetic field for the particular case under consideration. Thus, with a heating current of about 200 amperes the intensity of the magnetic field at a point distant 0.5 mm. from the middle of the plate is about 120 c.g.s. units, at 5 mm. from the plate it is still 63 units. Now, with a heating current of this strength the temperature of the plate is nearly 2700° C., and under these conditions the red fringe is ordinarily not perceptible to eye observations. Since, however, there is good reason for presuming that the conductivity of the vapours in the neighbourhood of a plate at this temperature must be fairly high, we can only account for the absence of the red fringe by supposing that the thermoelectronic current is being held in check by the magnetic field set up by the heating current. This view seems to receive strong support by the fact already recorded in § 5—namely, that the application of a magnetic field of only about 125 c.g.s. units acting upon the thermoelectronic current in a downward sense, *i. e.* in a direction opposed to that of the magnetic force due to the heating current, suffices to bring the red fringe into view. Further, as will be shown in the next paragraph, when the spreading downwards of the thermoelectronic current is helped by an additional magnetic field of sufficient strength, the red fringe emission no longer stops abruptly, but dies out only gradually. On the other hand, if in the case of the fully developed red fringe, at a plate temperature of about 3000° C., an additional magnetic field be applied acting in the same sense as that due to the heating current, the red fringe is forced up against the plate, appearing as it were in a state of compression, and its spectrum emission is now seen to stop quite abruptly at the lower edge. These facts seem to me to provide the basis for a satisfactory explanation of the sharp outline presented by the red fringe. Supposing there were no magnetic field set up by the heating current, then the thermoelectronic currents would be enabled to diffuse freely through all those parts of the vapours which possess the necessary degree of ionization. Now, since the latter is primarily controlled by the plate temperature, the conductivity of the vapours would diminish only slowly on passing downward from the plate. Consequently, the intensity of the thermoelectronic current would likewise fall off only slowly on passing through regions of gradually decreasing temperatures, and, as a matter of course, the red fringe would not present a uniform band with a sharp outline, but would fade away by degrees on passing downward from the plate—a result which would be quite contrary to the observed

facts. Thus we are led to conclude that a magnetic force acting upwards, such as is provided by the magnetic field due to the heating current, is responsible for the sharply defined edge which characterizes the red fringe.

§ 9. *Displacements of red fringe emission by transverse magnetic fields.*

In accordance with the assumption made in § 7—namely, that the red fringe emission is controlled by the thermoelectronic current, its characteristic spectrum lines and bands should be observed to lengthen or shorten whenever a magnetic field is brought to act upon the current in a downward or upward sense. A large number of photographic records of the fringe spectrum in the presence of a magnetic field have been secured and all, without exception, show up the intimate connexion between the fringe emission and the thermoelectronic current. A few selected records are reproduced on Plates III. to V. Those on Plate III. were obtained at a temperature of about 2700° C. *a* shows the normal development of the spectrum in the violet and ultra-violet regions without the action of a magnetic field, other than that due to the heating current. As already mentioned in § 5, the red fringe is not visible under these conditions, since the red bands come out only at the higher plate temperatures. But the carbon bands at 3883 and 4216, as also numerous titanium lines, are quite conspicuous, although they pass down only a relatively short distance as compared with *a* on Plate II., which was obtained at a temperature of 3000° C. The sharply bordered continuous emission extending downwards from the graphite plates on *a* and *c* is due to the bluish vapour described in § 4, which in these two cases was particularly intense near the lower edge. *b* shows the effect of a magnetic field of 175 c.g.s. units acting downwards, *i. e.* in opposition to that set up by the heating current. All the bands and lines of the fringe spectrum now reach much farther down from the plate and pass into regions where the temperature must be considerably lower. A word of explanation is due here with regard to the strong continuous spectrum and the marked lengthening of the lines emitted by the luminous vapour. These are caused, as will be shown in the next communication, by the spiral paths along which the luminous particles move under the combined influence of the electric and magnetic fields. *c* was obtained under similar temperature conditions as *b* and with a magnetic field of the same strength, but with the latter acting upwards, *i. e.* in the same sense as the magnetic field

due to the heating current. Only traces of the carbon bands and titanium lines are now visible in the vicinity of the plate.

The next two photographs, on Plate IV., were obtained with a plate temperature of about 3000° C., at which the red fringe is ordinarily well developed. *a* was taken with a magnetic field of 590 c.g.s. units acting upwards. The relative intensification and the sharply marked boundary line of the fringe spectrum make it appear as though the stream of emission centres created by the thermelectronic current were being pressed up against the graphite plate by the acting magnetic force. This is, of course, quite in agreement with the views expressed in the preceding paragraph. It is well also to draw attention to the fact that the lines of the second emission—namely, that given out by the luminous vapour and caused by thermo-chemical excitation—continue to die out gradually on passing away from the plate, in spite of the magnetic field. *b* shows the fringe spectrum under the same conditions as regards temperature and strength of magnetic field, except that the magnetic force is pulling the thermelectronic current downwards. With this strong field the thermelectronic current spreads to a very considerable distance from the plate and it is interesting to note that under these conditions the lines and bands of the fringe emission do not stop abruptly but die out only slowly (comp. § 8). The continuous spectrum and the lengthening of the vapour lines are again due to the spiral paths of luminous particles carrying electric charges.

In all the experiments described so far in this paragraph the luminous effects due to the thermelectronic current were observed only beneath the graphite plate and, even with a magnetic field of 590 c.g.s. units acting upwards, no trace of the fringe spectrum was ever seen above the plate. Stronger magnetic fields exerted such a pull on the thin graphite plates that the latter invariably broke before the necessary temperature was reached. But by using shorter plates, having an effective length of only 21 mm., fields of up to 1300 c.g.s. units could be applied for a sufficient length of time to secure a photographic record. In this way it has been possible to observe the red fringe above the plate and to obtain the photograph of its spectrum which is reproduced on Plate V. This record, I believe, constitutes the most striking and convincing proof for the electrical origin of the fringe spectrum. I was unable to ascertain whether the emission of the fringe spectrum above the plate is due to a thermelectronic current having passed out from the upper surface (covered with a layer of carborundum) or, what is perhaps more likely, to the forcing upward, round the side of the plate, of part of

the red fringe originated below. But, in either case, the result is of the utmost importance with regard to the cause of the fringe emission. The strong continuous spectrum, due to the edge of the plate, is slightly widened owing to the bending of the latter under the stress of the magnetic force. Below the plate the spectrum shows the usual development, except that the bands and lines of the fringe emission are appreciably shortened by the strong magnetic field. The lines emitted by the luminous vapour pass, as usual, much farther down and fade away only gradually. Now, on this side of the plate all these lines are fairly strong as compared with those of the fringe spectrum. But in the region above the graphite plate we find, on the contrary, that the fringe spectrum is relatively more important than that due to the vapours. Thus, to cite only one example, the two aluminium lines 3944 and 3962, which, below the plate, are much brighter than neighbouring titanium lines, are, above the plate, relatively fainter than these same lines of the fringe spectrum, although they pass to a greater height. It is evident, therefore, that the two emissions—namely, that due to thermo-electrical excitation and that caused by thermo-chemical excitation, are differently affected, and we are led to assume, either that only a small amount of luminous vapour is present above the plate, or that the temperature here is considerably less than what it is below the plate. But, whichever explanation holds, this record constitutes an indisputable proof for the reality of the existence of two independent emissions and, furthermore, from the total experimental evidence furnished in the course of this paragraph, it is manifest that the emission of the red fringe spectrum is primarily controlled by the thermelectronic current and not merely by the temperature of the plate.

§ 10. *Possible cause of excitation of red fringe spectrum.*

The spectroscopic evidence furnished by this research goes to show that the thermelectronic current on passing through the ionized vapours (probably carbides) in the vicinity of the hot plate of graphite, is responsible only for the emission of the spectra of carbon, titanium, vanadium, and some bands of unknown origin. There is indeed no indication that the lines of iron, manganese, potassium, sodium, etc., are in the least influenced by it under these particular experimental conditions. It will, however, be shown in a subsequent communication that when the intensity of the acting electric field is increased (in the present case the electric

field was always less than $8 \frac{\text{volts}}{\text{cm.}}$), the lines of other elements become likewise affected under similar temperature conditions. It will, further, be shown that the carbon bands originate always at an anode, whereas metal lines are almost invariably associated with a cathode. These various facts seem to me to point to some electrolytic process as underlying the cause of their emission, such as Professor Schuster has suggested in explanation of the discharge of electricity through gases. On this view the function of the thermelectronic current would be to decompose molecules of carbon and of its compounds at the surface of the incandescent plate, as well as along the entire path marked by the red fringe and to cause the formation of positive and negative radiating atom-ions.

§ 11. *Discussion of results and their application to the case of the electric tube resistance furnace.*

The experiments described in this paper have shown most conclusively that, when a plate of graphite is raised to a high temperature by passing an electric current through it, the light radiations given out by the luminous vapours in its vicinity are due to two entirely different emissions, one of which is controlled by the plate temperature and the other one by the thermelectronic current. As was pointed out in § 1, such a plate may be regarded as having been formed by cutting a tube open longitudinally and rolling it out flat. If, now, in like manner we imagine our plate to be rolled back, and its sides to meet and close up again, so as to form a tube once more, would it be justifiable to conclude *a priori* that the luminous phenomena exhibited by the interior of such a tube, raised to a high temperature by passing an electric current through it, will be fundamentally different in character from those previously observed with the plate?

Furthermore, would it be possible to presume without prejudice that all the electric actions, so manifestly prominent in the vicinity of a simple plate, will, in the case of a tube-furnace, be quite ineffective and that all the spectroscopic phenomena observed in such a furnace will be solely controlled by temperature?

In order to answer these questions we must examine whether and in how far, the conditions which govern the formation of the thermelectronic current, as revealed by the experiments with a graphite plate, are fulfilled in the

270 Mr. G. A. Hemsalech: *Excitation of Spectra of Carbon*, case of a tube-furnace. These conditions may be summarized as follows:—

1. High degree of ionization of the gases and vapours in the neighbourhood of the hot graphite;
2. An electric field of sufficient strength to drive an electric current through the ionized vapours and gases;
3. A minimum magnetic field due to the heating current, so as not to restrict the spreading out of the thermoelectronic currents;

and to these may perhaps be added,

4. Maximum photo-electric actions favouring the emission of electrons.

Before discussing the particular case of the tube-furnace it will be useful to recall the difficulties which were encountered in the endeavour to realize the necessary conditions with the simple plate. It was shown in this case that the loss of heat by radiation and convection was very considerable, and therefore, in order to maintain the plate at a high temperature, very heavy electric currents had to be forced through it. Further, owing to the upward rush of cool air from below the plate, the ionization of the vapours to the desired degree was always difficult to effect, and its accomplishment necessitated a very much higher plate temperature than would have sufficed in the absence of air draughts. As we have seen, the minimum plate temperature at which the spectroscopic effects of the thermoelectronic current begin to manifest themselves is about 2700° C. The heating current required to attain this temperature gives rise to a magnetic field of such magnitude as to seriously check the spreading out of the thermoelectronic current. Also, since photo-electric actions in the case of a plane surface can only take place between immediately adjacent points, the emission of electrons from this cause cannot be very great. Hence we find that in the case of an electrically heated plate, some of the essential factors in the formation of the thermoelectronic current are either unfavourable or even opposed to it, and the desired effect was only obtained by passing a heating current of high density through the plate, entailing the establishment of an electric field of up to $8 \frac{\text{volts}}{\text{cm.}}$. Now, if instead of a single plate, two parallel plates, each of only about half the thickness

of the former, are used, one above the other, and the heating current divided between them, it is easy to see that all the necessary conditions for the formation of the red fringe will be appreciably improved. First, the better shielding of the vapours in the space between the two plates from the uprising air, and their exposure to a radiating surface of twice the former area, will considerably facilitate their ionization, which will, already at lower plate temperatures, attain a high degree. Consequently, thermoelectronic currents will be enabled to pass under the action of feebler electric fields. Secondly, the heating current through each plate will be markedly less and consequently give rise to feebler magnetic fields; but since the magnetic forces due to each plate act in opposite directions in the enclosed space, the resultant magnetic field will almost vanish, and therefore the ionization currents will be able to diffuse through the vapours without restraint. Lastly, any possible photo-electric action will have a very much greater value with a two-plate arrangement, because the two radiating surfaces face each other. Now, as will be shown in a subsequent communication, these considerations are fully borne out by the observed facts, for with two parallel plates 5 mm. apart the red fringe is observed already at 2200° C. with an acting electric field of only about $4 \frac{\text{volts}}{\text{cm.}}$ and, further, in evidence of the absence of any appreciable magnetic field within the region bounded by the two plates, the red fringe is not confined to the immediate vicinity of the plate surface, but fills out evenly the whole of the enclosed space. Yet, notwithstanding the quite notable improvement observed, as compared with the single plate, the loss of heat through radiation and convection, in the case of two parallel plates, is still very considerable, because the sides remain unprotected. Hence we should expect to gain a further improvement by having these open sides likewise closed, and we are thus led to anticipate that the best arrangement, fulfilling the conditions enumerated, will be provided by a tube. Let us then examine, with the help of all known facts about the tube-furnace, in how far the conditions underlying the establishment of thermoelectronic currents are satisfied in the case of a tube :--

1. An extremely high degree of ionization in tube-furnaces was first shown to exist by Messrs. Harker and Kaye. These results were entirely confirmed by my own experiments.

2. In a tube-furnace which is well protected from loss of heat by means of a thick layer of carborundum powder, the heating current necessary to raise the tube to a certain temperature will naturally be less than if the tube were not so protected; for there are practically no heat losses to make good as compared with the single plate or even the two-plate arrangement. Consequently, with such a tube-furnace, the drop of potential along the tube will be relatively small and, in my particular case, it was only about $1.05 \frac{\text{volt}}{\text{cm.}}$ for a temperature of 2600°C. , as against $5.5 \frac{\text{volts}}{\text{cm.}}$ in the case of the single plate. Hence, the acting electric field in a tube-furnace protected against heat losses in the manner stated is relatively small and may even not suffice, especially at the lower temperatures, to produce all those spectroscopic effects which were observed with the single plate.
3. The magnetic field inside a tubular conductor is zero*. Thus, if the conductivity of the vapour has the necessary value, thermoelectronic currents will pass absolutely unimpeded by magnetic forces and be controlled solely by the degree of ionization prevailing in the interior.
4. Photo-electric actions should be very great in this case since every point is acted upon from all round the circular wall.

Thus we see that, with the possible exception of condition 2, there is a great likelihood that the electric actions, which have been shown to underlie the luminous phenomena constituting the red fringe, should also prevail in the interior of a tube-furnace.

Let us then examine more closely in how far the spectroscopic results obtained with the tube resistance furnace agree with my observations on the spectrum of the red fringe. Since the magnetic field inside the tube-furnace is zero the red fringe, or its equivalent, should fill out the whole space, as in the case of the two parallel plates. It will be remembered that I found the light given out by the interior of the tube-furnace, up to a temperature of from 2400 to 2500°C. , to be of purple tint †. This, of course, suggested

* Sir J. J. Thomson, *Elements Mathem. Theory of El. & Magn.*, 3rd ed. p. 323.

† Hemsalech, *Phil. Mag.* vol. xxxvi. p. 214 (1918).

the emission of red radiations. Now, a re-examination of my old spectrograms referring to the tube-furnace has revealed the presence of the characteristic bands of the red fringe; but although they coincide in position, their character is markedly different from that observed with the plate, for they are much less intense and, what is more noteworthy, nothing like as hazy. To give an idea of their relative unimportance in the case of the tube-furnace, it may suffice to mention that the more sharply defined calcium bands at 6185 and 6211, which are completely masked by them in the spectrum of the red fringe as obtained with the single plate, are distinctly brought out. It will be shown in a subsequent paper that, when two parallel plates are used, the red bands of the fringe spectrum, although much more intense and prominent than in the tube-furnace, are nevertheless appreciably reduced in haziness and extent as compared with their development in the case of the single plate. Now, the only vital factor which changes appreciably on passing from the single plate to the two-plate arrangement and the tube-furnace, is the intensity of the electric field. Thus, with the single plate, the red bands begin to show only with an electric field of about $7 \frac{\text{volts}}{\text{cm.}}$; with the two-plate arrangement they come out with only about $4 \frac{\text{volts}}{\text{cm.}}$, and in the tube-furnace already with less than $1 \frac{\text{volt}}{\text{cm.}}$; the diminishing values for the intensities of the electric fields are, of course, in keeping with the higher degrees of ionization which prevail in the case of the two parallel plates and in that of the tube-furnace. These facts and considerations seem to indicate that the red bands, being as they are stimulated by electric actions, will be susceptible also to variations of the acting electric force, and it may, therefore, reasonably be conceived that the extraordinary haziness and intensity which characterize them in the red fringe are caused by the relatively strong electric field which is created by forcing a heavy current through the graphite plate. I hope to show in a subsequent paper that the lines of the doublet series of sodium are similarly affected when acted upon by strong electric fields. Hence the weakness and the relatively low degree of haziness of the red bands in the tube-furnace are quite consistent with the feeble electric field prevailing therein.

The lines of titanium and vanadium have not been observed by me in the tube-furnace; it is possible that these elements are not contained as impurities in the carbon tubes

employed. But it is of interest to note that the lines of these elements have been recorded as impurities by Dr. King in a tube-furnace made of the same material as my plates—namely, Acheson graphite*. This important observation points most forcibly to the presence of thermelectronic currents in a tube resistance furnace.

We now pass on to examine the relative behaviour of the remaining constituents of the red fringe spectrum—namely, the carbon bands. These, as was shown in § 7, consist of the so-called cyanogen bands and those of the Swan spectrum. The strong band at 3883 is the first to appear as the temperature of the plate gradually rises, and its first traces were detected already at 2500° C., whereas the complete spectrum was observed only at about 3000° C., the Swan bands being the last to come out. In conformity with the more effective ionization of the vapours, and the absence of an internal magnetic field in the tube-furnace, we shall naturally expect to observe the carbon bands in the latter already at much lower temperatures than with the single plate. Now, according to my own observations†, the first trace of the carbon spectrum—namely, the head of the so-called cyanogen band at 3883, was noted already at a temperature of only about 1900° C. As the furnace temperature and consequently also the acting electric field were increased, the carbon spectrum developed further by the additional emission of the band at 4216. Finally, at temperatures of above 2500° C., the bands of the Swan spectrum came also into view and thus the spectrum attained a similar degree of completeness to that observed in the red fringe. From these observations we elicit the double fact that the carbon spectrum emitted by the tube-furnace is not only of precisely the same character as that given by the red fringe, but also that its gradual development with increase of temperature and electric field proceeds in exactly the same order as that noted therein. As I have already pointed out, this order of development is just the reverse to that observed when the emission is caused by chemical excitation, such as prevails in the explosion regions of the various hydrocarbon flames. Hence the emission of the carbon bands in the tube-furnace cannot be ascribed to chemical actions of this nature. Further, it cannot possibly be due to thermal or thermo-chemical actions alone, because none of these bands are emitted by the hottest regions in the mantles of carbon flames. Finally, it has been conclusively

* A. S. King, *Astrophysical Journal*, vol. xxxvii. p. 250 (1913).

† Hemsalech, *Phil. Mag.* vol. xxxvi. p. 225 (1918).

proved that, in the red fringe, the emission of the carbon bands is primarily governed by electric actions, the temperature serving only to ionize the vapours in the vicinity of the plate. Hence, since both the character and the order of development of the carbon spectrum as given by a tube-furnace are fundamentally identical with those observed in the red fringe, we can only conclude that their emission by the former is due to the same cause—namely, the passage of thermelectronic currents through highly ionized vapours and gases. Thus, if it were possible to exclude thermelectronic currents from the interior of the tube, no carbon bands should be observed, as is the case in the mantles of hydrocarbon flames up to 2700° C.

The arguments brought forward in this discussion lead to the inevitable conclusion that thermelectronic currents, just as in the case of the red fringe, are responsible also for the emission, in the tube-furnace, of the carbon bands and the red bands of unknown origin. The mere fact that a plate has been rolled up into a tube can therefore not in the least affect the fundamental character of the luminous phenomena observed in its vicinity; on the contrary, several of the essential conditions for their production are thereby greatly improved. The relatively feeble development of the red bands in the tube-furnace can be most satisfactorily accounted for by the feebler electric field existing in the latter; and this view is entirely corroborated by my observations with a parallel-plate furnace, in which both the intensity of the acting electric field and the state of development of the red bands were intermediate between those noted with the single plate and the tube-furnace.

With regard to the spectrum emission of the luminous vapour, the lines and bands of which are observed to extend below the red fringe spectrum, it has been proved in § 7 that it is of the same character as that emitted by these vapours in the tube resistance furnace and in the mantles of flames under the influence of thermo-chemical excitation. The present experiments with the single plate have, therefore, also furnished an independent confirmation of the existence of this emission in the tube-furnace.

§ 12. *Probable cause of disagreement between Dr. King's results and mine.*

I have shown * that a tube resistance furnace, worked with continuous current, emits class III. lines of iron only at

* Hemsalech, *Phil. Mag.* vol. xxxvi. p. 214 (1918).

temperatures above 2500°C .; even of the bright group at 4957, no trace was ever detected below 2500°C . I have further pointed out, that this observation is quite in harmony with the results of my investigations on the flame spectra of iron. In this case also, there was no sign of class III. group 4957 up to the temperature of the oxy-hydrogen flame—namely, 2550°C ., and only mere traces of it were observed in the oxy-acetylene flame at 2700°C . But, when the temperature of the tube-furnace was raised to 2700°C ., the spectrum of iron emitted by it, besides being of great brilliancy, showed a remarkably high degree of development, with group 4957 as quite a conspicuous feature; in fact the character of the spectrum had completely changed and now approached more that stage which it generally attains in the arc. Thus, the spectrum of iron, as emitted by my tube-furnace at 2700°C ., was found to be entirely different from that given by the oxy-acetylene flame at the same temperature. Had the emissions of the iron spectra in these two cases been solely controlled by temperature, then surely the spectra given by these two sources would have been identical, at least in so far as the relative intensities of the lines were concerned. From the very fact that this was not the case, and also from several other considerations, I had arrived at the conclusion that the emission of class III. lines by the tube-furnace was caused by part of the heating current passing through highly ionized iron vapour, and that the iron spectrum observed under these conditions should be regarded as a low-tension arc spectrum. This conclusion appeared to receive confirmation by the negative results of an experiment with a special plate-furnace, in which the acting electric field was greatly reduced. No trace of class III. group 4957 was ever seen with this furnace, although the observations were continued up to the moment when the plate burnt through and the temperature, as is well known, had reached a maximum value. As Dr. King has rightly pointed out, I ought to have observed at least those lines which are caused by the action of heat upon the carbides of iron; but unfortunately I had been unable to obtain a photographic record of the spectrum on account of a breakdown of the dynamos, and I have no doubt that such a record would have shown class I. and II. lines. As it was, however, I had concentrated my attention upon the detection of group 4957 of iron and the Swan bands of carbon, neither of which were observed. The strong continuous spectrum, always present, may possibly have contributed to render the other lines less conspicuous,

but there was also as intense a continuous spectrum emitted by the high-temperature tube-furnace, yet, in spite of it, the complete iron spectrum, including class III. lines, stood out most brilliantly.

Now, my observations do not apparently harmonize with the results obtained by Dr. King, who has photographed group 4957 of iron already at temperatures of between 1800° and 1900° C., and in one case even at 1650° C.* There can be no doubt that the range of temperatures given by Dr. King's furnace is the same as that available with mine—namely, from about 1500° to 2700° C., and, if the emission of class III. lines of iron were solely controlled by the temperature comprised within these limits, I should most certainly have seen them, or secured them photographically on one or other of the many records taken. The double fact, that class III. lines of iron were not observed in my furnace, nor in the mantles of flames at corresponding temperatures up to about 2500° C., seems to me to indicate clearly that there must be some other factor present in Dr. King's furnace which is responsible for the emission of these lines at low temperatures. Let us then examine more closely whether there is any fundamental difference between the furnace arrangement used by Dr. King and mine. As will be remembered, my furnace was formed by a carbon tube of 14 mm. internal diameter and an effective length of about 10 cm. The heated portion of the tube was well protected against loss of heat by means of a thick layer of carborundum powder. The heating current supplied to the tube was continuous. The drop of potential along the tube, for temperatures of from 2600° to 2700° C., was about $1.05 \frac{\text{volt}}{\text{cm.}}$. On the other hand, Dr. King's furnace consists

of a tube of Acheson graphite having 12.5 mm. internal diameter and an effective length of about 20 cm.† The tube is not protected by a carborundum jacket, but is enclosed in a steel chamber, which is pumped out to a pressure of less than 2 cm. of mercury. Owing to the greater loss of heat through radiation entailed by this arrangement, it requires a larger current to produce the same furnace temperature as with a well protected tube, such as is the case with my furnace. Accordingly, a potential of 30 volts has to be applied to Dr. King's tube in order to bring the temperature to between 2600° and 2700° C. This corresponds to a

* A. S. King, *Astroph. Journ.* vol. xlix. p. 48 (1919).

† A. S. King, *Astroph. Journ.* vol. xxxvii. p. 120; *ibid.* p. 240 (1913).

278 Mr. G. A. Hemsalech: *Excitation of Spectra of Carbon*, potential gradient along the tube of about $1.5 \frac{\text{volt}}{\text{cm.}}$. Furthermore, Dr. King's furnace, unlike mine, is worked with alternating current, and the instruments employed in measuring volts and amperes give, of course, only the root-mean-square values of these quantities. Now, the value for the potential gradient along the tube reaches two maxima during each complete cycle of an alternation, which are equal to 1.4 times the root-mean-square value as read on the voltmeter. In the case of Dr. King's furnace this amounts to $1.4 \times 1.5 = 2.1 \frac{\text{volts}}{\text{cm.}}$ for a furnace temperature of between 2600° and 2700° C. In like manner, at a temperature of between 1800° and 1900° C., a potential of 15 volts has to be applied in order to drive the necessary heating current through the tube, and the maximum value of the potential gradient works out to $1.05 \frac{\text{volt}}{\text{cm.}}$. For the sake of convenience the numbers found for the potential gradients along the furnace tubes in the two cases are restated in the following table:—

Temperature.	Continuous current ; tube well protected with carborundum powder. (Hemsalech.)	Alternating current tube unprotected. (Dr. King.)
$1800\text{--}1900^\circ$ C.	Not recorded.	$1.05 \frac{\text{volts}}{\text{cm.}}$
$2600\text{--}2700$ „	$1.05 \frac{\text{volts}}{\text{cm.}}$	2.1 „

These figures reveal the fundamental difference between Dr. King's and my furnace—namely, the acting electric field is twice as powerful in the unprotected tube run with alternating current as in the protected tube worked with continuous current. Already at the lower temperature of between 1800° and 1900° C., Dr. King's furnace gives an electric field of such strength as mine attains only at between 2600° and 2700° C. Hence it is quite evident that for a given furnace temperature thermelectronic currents will reach a much higher development in Dr. King's furnace than in mine, and we must, therefore, expect that his furnace will show spectrum lines and bands which cannot be seen in mine under the same temperature conditions. Thus Dr. King's furnace, thanks to its stronger electric field, will show lines at the low temperature which my furnace, owing to its feebler electric field, only shows at the high temperature. This is precisely what has been observed

with regard to class III. group 4957 of iron. The stronger electric actions in Dr. King's furnace have brought this group out at already 1800°C ., whereas in my furnace it shows only at over 2500°C . when the acting electric field reaches about the same value as that prevailing in Dr. King's furnace already at the lower temperature. Further, the enhanced spectroscopic effect due to the stronger electric actions in the alternating current furnace, is proved beyond doubt by Dr. King's observation that in his furnace the cyanogen bands are *strong* at 1850°C .^{*} Now, these bands, which, as has been firmly established in the course of the present research, are directly excited by the thermelectronic current, are *feeble* in my furnace at about the same temperature, in fact only the head of the brighter band—namely 3883, has been detected at about 1900°C .

It might be contended with regard to the electric effect of the alternating heating current, that the short duration of the maximum value of the voltage reached twice during each cycle may not suffice to appreciably affect the excitation of spectrum radiations. Against this we have, however, the very important experimental evidence by Dr. de Watteville who, by a most ingenious method, has shown that the spectrum emission follows very closely the periodic variations in an alternating current circuit †. But in this connexion it is well to draw attention to the possibility of the furnace temperature being likewise subject to periodic fluctuations, owing to the rise and fall of the intensity of the heating current. The temperature, as indicated by a pyrometer, would represent the average during a cycle; but it is just possible that the temperature, and therefore also the degree of ionization, may momentarily reach a much higher value than this, and this higher value would occur nearly simultaneously with the maximum of the acting electric field. Thus, in certain circumstances the running of an electric furnace by means of alternating current may, also from this point of view, affect the estimation of the true character of the spectra emitted by the luminous vapours. It is probable, however, that in a well protected furnace tube, temperature variations of the kind here suggested will not be of great amplitude; but, in the case of an unprotected tube, which loses heat rapidly through radiation, such as is precisely the case in Dr. King's arrangement, the possible effects upon temperature and ionization of the periodic variations in the

* A. S. King, *Astroph. Journ.* vol. xlix. p. 50 (1919).

† C. de Watteville, *Comptes Rendus de l'Académie des Sciences*, séance du 22 février, 1904.

280 Mr. G. A. Hemsalech: *Excitation of Spectra of Carbon*,
intensity of the heating current, should receive careful attention.

When considering the action of an alternating current furnace it is necessary also to bear in mind, that the diffusion of the thermelectronic current through the ionized vapours in the interior might, to some extent, be influenced by the skin effect. This would, under certain conditions, cause the complete stoppage of electric currents near the axis of the tube. But it is to be presumed that, with the low periods generally employed for heavy alternating currents—namely from 50 to 100 per second, the thermelectronic currents will nearly reach the centre. Dr. King has made some interesting experiments which directly bear on this point*. Two graphite exploring rods were inserted into the tube from opposite ends. The inner end of one rod was placed in the hottest part of the tube, and that of the other rod in the cooler region near the end. A direct current ammeter, placed in the circuit connecting the two exploring rods, registered a current of about 1.5 amperes at a furnace temperature of about 2600° C. The rod in the hot part had, of course, become a cathode and, together with the cooler anode, acted as a rectifier for the alternating current, part of which leaked across the space from the inner wall to the rod in the centre. Thus there is little doubt that in Dr. King's furnace thermelectronic currents will be enabled to pass very near to the axis of the tube. Dr. King has further shown that the degree of ionization decreases rapidly with increasing pressure; it is therefore important to record the fact that most of Dr. King's observations on furnace spectra were made at low pressure, whereas all mine have been carried out at atmospheric pressure.

With regard to the line emission of iron which is caused by thermo-chemical excitation, there is little doubt that its state of development at a given temperature, in the alternating current furnace, will be the same as that observed in the continuous current one. But, with the former type of furnace, especially when the tube is unprotected, the second line emission—namely, that due to thermo-electrical excitation, becomes perceptible already at the lower furnace temperatures; consequently, the iron spectrum which is observed under these conditions will, already from the outset, be the result of the superposition of two different

* A. S. King, *Astroph. Journ.* vol. xxxviii. p. 331 (1913).

emissions. Now, since both the furnace temperature and the intensity of the acting electric field will rise simultaneously when the heating current is increased, the progressive developments of the two emissions will likewise proceed simultaneously, and it is no doubt owing to this fact that the composite character of the iron spectrum, as given by an insufficiently protected alternating current furnace, has escaped the attention of Dr. King. For, as I have shown, with a well-protected continuous current furnace, though the range of temperatures produced is the same, the second emission, on account of the much feebler electric field, manifests itself only at temperatures of over 2500° C.—namely, after the first emission has already attained a high degree of development. And it is probably thanks to the smaller electric field of my furnace that such good agreement was found to exist between the furnace and flame spectra of iron up to about 2500° C., because the spectrum of this element as emitted by my furnace up to this temperature was entirely caused by the action of heat on a compound of iron under the sole control of the prevailing temperature.

§ 13. *Summary of Results.*

1. The existence has been established of a new luminous phenomenon which manifests itself as a sharply defined band, of pinkish hue, in the immediate vicinity of a plate of graphite raised to a high temperature by means of an electric current. The name *red fringe* has been applied to this luminous band. § 4.
2. It is shown that the red fringe is caused by an electric current, which is probably part of the heating current. § 5.
3. The red fringe is not solely controlled by the plate temperature, for it can be made to appear or disappear at will by the simple action of magnetic forces, without altering the temperature. § 5.
4. It is shown that the electric current underlying the formation of the red fringe is quite distinct from thermionic currents, not only as regards sensitiveness to the magnetic force, but also and particularly as to the spectroscopic effects produced. In order to clearly distinguish between the thermionic current and that which gives rise to the red fringe, it is proposed to call the latter the *thermelectronic current*. § 6.

5. Spectroscopic examination has revealed the existence of two entirely different and distinct emissions by the luminous vapours in the neighbourhood of the heated plate. One of these emissions is controlled by the plate temperature and is due to thermo-chemical excitation. The lines and bands which compose its spectrum are observed to die out only gradually on passing away from the plate. The second emission is confined to the immediate vicinity of the plate, and in extent it coincides with the red fringe. It is further shown that this emission is controlled by the thermelectronic current and is therefore due to thermo-electrical excitation. The characteristic feature of its spectrum is that its lines and bands, unlike those of the first emission, stop quite abruptly at the lower edge of the red fringe. § 7 and § 9.
6. The spectrum of the first emission (thermo-chemical excitation) is composed of the lines or bands of the more volatile metals, such as Na, Li, Sr, K, Al, Ca, Mn, Fe, etc.; that of the second emission (thermo-electrical excitation) is constituted of the bands of carbon, the lines of titanium and vanadium, and a group of characteristic red bands of very hazy appearance. § 7.
7. The gradual development of the carbon spectrum with thermo-electrical excitation is in the reverse order to that observed with chemical excitation. It is further pointed out that this spectrum is not emitted by the hottest parts of the mantles of the air-coal gas, oxy-coal gas, and oxy-acetylene flames. Consequently, it is not excited by thermal or thermo-chemical actions up to a temperature of 2700° C. § 7.
8. The sharp outline presented by the red fringe is caused by the magnetic field around the plate due to the heating current. This magnetic field has a tendency to drive the thermelectronic current back towards the plate, and it thus prevents the diffusing downwards of even the least part of this current. § 8 and § 9.
9. A discussion of the thermal, electric, and magnetic conditions existing in the vicinity of an electrically heated plate, as compared with those prevailing in the interior of a tube resistance furnace, has led to the inevitable conclusion that thermelectronic currents will be enabled to pass through the ionized vapours in the latter already at a comparatively low temperature, and moreover, they will diffuse without difficulty throughout the

whole inner space of the tube, because the magnetic field due to the heating current is zero. Furthermore, the character and order of development of the carbon spectrum in the tube-furnace, as compared with that in the red fringe, indicate plainly that, also in the furnace, its emission is caused by thermelectronic currents. § 11.

10. It is pointed out that the disagreement between the furnace results obtained by Dr. King and myself is most probably due to the different arrangements employed. Dr. King's furnace tube, being unprotected, requires a greater heating current and consequently a stronger electric field to raise it to a given temperature than is necessary for a furnace tube which is well protected against heat losses by means of a carborundum jacket. Further, by using alternating current for heating the tube, the electric field reaches a maximum value of 1.4 times that given at the same temperature with continuous current heating. For these two reasons the maximum acting electric field in Dr. King's furnace is twice as strong as in mine for any given temperature. Hence, lines or bands the origin of which can be directly traced to the action of thermoelectronic currents, such as the carbon bands and class III. lines of iron, will in the unprotected alternating current furnace show already at much lower temperatures than in a well-protected continuous current furnace. § 12.

§ 14. *Concluding Remarks.*

The present investigation has furnished most conclusive results in evidence of the emission, by the tube resistance furnace, of luminous radiations which depend for their excitation upon electric actions. It has further been shown that the spectroscopic effects produced in this way are governed by the acting electric field and the state of ionization of the vapours. They depend upon the furnace temperature only in so far as the latter controls the electrical conductivity of the vapours. If the furnace be well protected from loss of heat and be worked with continuous current, the electric field which is established at the lower temperatures may be too small to stimulate those atomic vibrations which are sensitive to electric actions. This has been shown to be the case with iron. If, on the other hand, the tube of the furnace be left unprotected and be heated with alternating

current, the electric field will, already at the lower temperatures, be of sufficient strength to give rise to traces of the electrically controlled emission. Now, since this emission naturally develops progressively, as the temperature and consequently also the electric field increase, the erroneous impression will be created that the observed spectrum (which is of course composed of the electrically controlled emission and that due to thermo-chemical excitation) is entirely governed by the furnace temperature.

It seems to me therefore highly probable that the electric tube resistance furnace, and in particular the special furnace arrangement used by Dr. King, is most unsuited to investigations having for object the study of the effect of temperature upon the spectrum lines of an element, because it is not possible with such furnaces to discriminate readily between the lines controlled by temperature and those, the emission of which depends upon electric actions. Hence, spectrum tables which are founded solely on furnace observations and purpose to give the variation of the spectrum with temperature, are necessarily misleading, since in their compilation no account has been taken of the composite character of the spectrum observed. One of the objects of experimental spectroscopy is to break up a complicated spectrum and to trace the origin of the various component parts, in order to pave the way for the search of still closer relationships between the various lines or groups of lines. This can often only be accomplished by lengthy comparative investigations under most diverse conditions. In this way I have shown, that the particular furnace emission of iron vapour which is controlled by temperature, is obtained by itself in the mantles of flames, where it can be observed to much better advantage than in the tube-furnace.

Hence it seems to me that the study of furnace spectra can only lead to trustworthy and useful results, if it be supplemented by an examination of both arc and flame spectra of the same element, the whole investigation being of course made, as far as possible, with the same spectrographic appliances.

Manchester, July 1919.

Note added November 27.

The hazy red bands of the fringe are due to the oxide and more especially the carbide of calcium. The oxides of strontium and barium when added to the carborundum, with

which the graphite plate is covered, give bands of similar appearance and likewise sensitive to thermo-electrical excitation. The strontium bands are situated in the red and the blue, and those of barium in the green. With the oxide of the last named metal the colour of the fringe is green. If none of these compounds is present in appreciable quantities the fringe has a bluish-violet tint.

The spiral and helical paths observed when a magnetic field is acting downwards are caused by the motions of positively charged particles emitted by the alkali metals. The temperature at which emission of positive particles begins varies inversely as the atomic weights of these elements. The deflexion of the positive streamer by a magnetic field provides a very sure guide as to the presence of these elements in minerals, &c.; and this method of detection is more rapid and convenient than the spectroscopic test. There are also indications of the emission of negative particles at higher temperatures and with stronger magnetic fields. It seems likely that the phenomena observed are analogous to those discovered by Sir J. J. Thomson in connexion with the emission of rays of positive electricity by gases at low pressures*. Thus the emission of positive particles by the alkali metals might possibly be caused by the breaking up of the molecular or atomic systems of these elements, which according to preliminary determinations would set in at approximately the following temperatures: lithium at 2700° C.; sodium, 2550°; potassium, 2300°; rubidium, 2200°; and caesium, 1900°.

XXVI. *Parametric Solutions for a Fundamental Equation in the general Theory of Relativity, with a Note on similar Equations in Dynamics.* By E. T. BELL †.

1. IT may be of interest to note that we can solve

$$ds^2 = \sum a_{ij} dx_i dx_j \quad (i, j = 1, 2, 3, 4), \dots \quad (1)$$

which is the point of departure for much recent work in the theories of generalized relativity and gravitation, very simply if we assume that s, x_1, x_2, x_3, x_4 are functions of four

* J. J. Thomson, *Phil. Mag.* vol. xxi. p. 225 (1911).

† Communicated by the Author.

286 Prof. E. T. Bell on *Parametric Solutions for a*
arbitrary functions

$$\xi_i \equiv \xi_i(u) \quad (i=1, 2, 3, 4), \quad . . . \quad (2)$$

where u is a parameter. In (1) the a_{ij} are functions of the x_i .

2. For brevity we shall assume that the right-hand member of (1) is reducible, in the usual way, to a sum of four squares,

$$ds^2 = \sum_{i=1}^4 (b_{i1}dx_1 + b_{i2}dx_2 + b_{i3}dx_3 + b_{i4}dx_4)^2, \quad . \quad (3)$$

subject to the condition that the determinant of the system

$$b_{i1}dx_1 + b_{i2}dx_2 + b_{i3}dx_3 + b_{i4}dx_4 = \phi_i(u) \quad (i=1, 2, 3, 4), \quad . \quad (4)$$

in which dx_1, dx_2, dx_3, dx_4 are the unknowns, does not vanish. If (1) is such that this reduction is impossible; viz., if the a_{ij} are such that no b_{ij} exist such that the determinant of (4) is different from zero, a slight and obvious modification of the algebra leads to a parametric solution of essentially the same sort as that now given.

3. The determinant of (4) not vanishing, we can solve for the dx_i , getting

$$dx_i = B_{i1}\phi_1(u) + B_{i2}\phi_2(u) + B_{i3}\phi_3(u) + B_{i4}\phi_4(u) \quad (i=1, 2, 3, 4), \quad . . . \quad (5)$$

in which B_{ij} are functions of the b_{ij} , hence of the a_{ij} , and therefore of the x_i alone. Hence, integrating,

$$x_i = \int (B_{i1}\phi_1(u) + B_{i2}\phi_2(u) + B_{i3}\phi_3(u) + B_{i4}\phi_4(u)) du; \quad . \quad (6)$$

or when the B_{ij} are independent of u ,

$$x_i = \sum_{j=1}^4 B_{ij} \int \phi_j(u) du \quad (i=1, 2, 3, 4). \quad . . \quad (7)$$

We shall now determine s and the $\phi_j(u)$ in terms of the functions (2) so that on substituting in (6), s and the resulting x_i reduce (1) to an identity. There are many ways of doing this; one of the most obvious is

$$s = \int (\xi_1^2 + \xi_2^2 + \xi_3^2 + \xi_4^2) du,$$

$$\phi_1(u) = \xi_1^2 + \xi_2^2 - \xi_3^2 + \xi_4^2,$$

$$\phi_2(u) = 2\xi_1\xi_2, \quad \phi_3(u) = 2\xi_2\xi_3, \quad \phi_4(u) = 2\xi_4\xi_3.$$

For, on putting these values of the $\phi_j(u)$ in (6), and then going back successively through (6), (5), (3), we get for the right-hand member of (3),

$$(\xi_1^2 + \xi_2^2 - \xi_3^2 + \xi_4^2)^2 + (2\xi_1\xi_3)^2 + (2\xi_2\xi_3)^2 + (2\xi_4\xi_3)^2,$$

which is identically

$$(\xi_1^2 + \xi_2^2 + \xi_3^2 + \xi_4^2)^2,$$

that is, ds^2 . Hence (3), and therefore (1) which is equivalent to (3), is identically satisfied by the indicated values of s, x_1, x_2, x_3, x_4 .

4. The same device of making the solution depend ultimately upon an identity connecting sums of squares, can obviously be applied to find parametric solutions of other equations occurring in general dynamics. It will be sufficient to indicate the identity applicable to

$$ds^2 = \sum a_{ij} dx_i dx_j \quad (i, j = 1, 2, \dots, n). \quad \dots \quad (8)$$

Suppose that the quadratic form on the right of (8) is algebraically reduced, in the ordinary way, to a sum of n squares,

$$ds^2 = \sum_{i=1}^n (b_{i1} dx_1 + b_{i2} dx_2 + \dots + b_{in} dx_n)^2, \quad \dots \quad (9)$$

such that the determinant $|b_{ij}|$ does not vanish. As before, special cases in which this reduction is impossible may arise; but they present no essential difficulty. Then, for $n > 1$, we resolve $n-1$ in any way into a pair of factors r, s so that $n = rs + 1$; and put

$$A_r = \sum_{i=1}^r \xi_i^2, \quad B_s = \sum_{j=1}^s \eta_j^2,$$

where ξ_i, η_j are arbitrary functions of a parameter u . Then the identity leading to a solution of (9), and hence of (8), is

$$(A_r + B_s)^2 = (A_r - B_s)^2 + 4A_r B_s. \quad \dots \quad (10)$$

For, on multiplying out $A_r B_s$, the right of (10) is a sum of $rs + 1 = n$ squares, viz.,

$$(A_r + B_s)^2 = (A_r - B_s)^2 + \sum_{i=1}^r \sum_{j=1}^s (2\xi_i \eta_j)^2; \quad \dots \quad (11)$$

and hence on putting

$$s = \int (A_r + B_s) du,$$

$$b_{i1}x_1 + b_{i2}x_2 + \dots + b_{in}x_n = \int \phi_i(u) du \quad (i=1, 2, \dots, n),$$

. . . (12)

where the functions $\phi_i(u)$ are identical in some order with the $2\xi_i\eta_j$, $(A_r - B_s)$ in (11), we get, on solving (12) for the x_i , a solution of (9) and hence of (8).

5. The cases of (8) in which the quadratic differential form on the right is reducible to a sum of $4\kappa + 3$ squares, where $\kappa = 0, 1, 2, 3, \dots$, are in many respects remarkable. In those cases it is always possible, in several essentially distinct ways, to obtain types of general parametric solutions in a form *free from all quadratures*. The same property holds also when the right of (8) is reducible to a sum of two squares. When the number of squares in the reduced form is three, the most immediate interpretations of (8) being to the theory of curves in three dimensional space, whether Euclidean or not, the solution has a particular interest. The cases of reductions to 2, 3, or 15 squares present in addition many properties not shared by other forms. The dynamical interpretation of the general case is evident in terms of the generalized velocities, momenta, and kinetic energy of a system, the last either in the Lagrangian or Hamiltonian form. Hence it may be expected that if the generalized coordinates of a system are $4\kappa + 3$ in number, the system will have special dynamical properties. In addition to these quadratic differential forms, there are many other classes of forms of degrees higher than the second possessing a like property that the solutions of equations between several such forms of the same kind may be very readily obtained in parametric form, not, however, free from quadratures. An account of all the cases mentioned in this note will shortly be published elsewhere. It may be of interest to remark that all of the general solutions free from quadratures, and those relating to forms of degree higher than the second, first presented themselves in some work relating to the theory of numbers.

University of Washington,
Seattle, Washington, U.S.A.

XXVII. *The Mandelstam Method of Absolute Measurement of Frequency of Electrical Oscillations.* By J. TYKOCINSKI-TYKOCINER, late Manager of the Radio Department of the Siemens and Halske Works at Petrograd*.

DURING the summer of 1915 a considerable number of wave-meters for radio-stations had to be calibrated in the Radio Department of the Russian Siemens and Halske Works in Petrograd, taken under the control of the Russian Government. The comparison of wave-meters calibrated by usual methods by different firms or by the Russian Chamber of Measures and Weights showed large discrepancies.

To enable a larger number of stations to work with each other without interference, not only has sharp tuning to be applied but the precise setting of the radio apparatus for a given wave-length is of paramount importance. A reliable method of wave-measurement reduced to the use of the simplest standard becomes of great necessity.

Dr. Mandelstam, chief expert of the Works' Research Department, investigating the behaviour of high-toned buzzers used at that time for generating high-frequency oscillations, for measurements and testing purposes, found that oscillations in a circuit energised by a buzzer do not depend solely on its capacity and inductance, but depend also upon the frequency of the pulsating current delivered by the buzzer, and to a large extent upon the character of its interruptions.

Mathematical analysis of the phenomena showed that a buzzer, because of the steepness of the curve A (fig. 1),

Fig. 1.

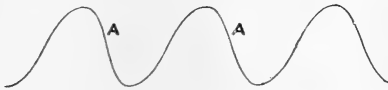

characterising the interrupting current, can be made, in connexion with another circuit, a source of trains of oscillations possessing a wide scale of frequencies. The amplitudes of the variety of oscillations obtained are not equal for all

* Communicated by Dr. L. Silberstein.

frequencies, but depend upon the ratio of the frequency of generated oscillations to the number of interruptions per second the buzzer is operating. Those oscillations, the frequencies of which represent exact multiples of the number of buzzer interruptions, have the largest amplitudes.

Basing himself on this result, Dr. Mandelstam devised (July 1915) and developed the following method of absolute measurements of frequencies used in radio work.

A buzzer B (fig. 2) giving regular interruptions and working from a battery of accumulators E excites an

Fig. 2.

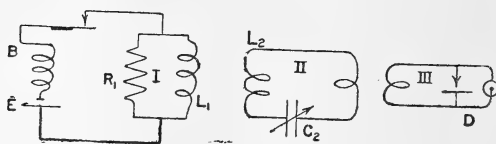

aperiodic circuit I consisting of a resistance R and inductance L. This circuit is a source of oscillations of all possible frequencies in accordance with Fourier's analysis of the curve A into sinusoidal components. Another circuit II, capable of performing free oscillations, with its variable capacity C₂ and inductance L₂ is inductively connected with the generating circuit I and with a circuit III, containing an indicating instrument D, as for instance a thermo-element with galvanometer or a detector with a telephone.

By variation of the capacity of the condenser C₂ a great number of maxima of the oscillating currents in II can be observed, arranged in definite positions all along the scale of the condenser C₂. Changing the number of interruptions per second of the buzzer produces the effect that the maxima come closer to each other if the number of interruptions decreases, or become widely separated if the number of interruptions increases. The use of a detector with a telephone in the indicating circuit III coupled with II gives a means of hearing a pronounced musical tone, corresponding to the frequency of interruption of the buzzer only in positions of the condenser C₂ which form circuits of multiple natural periods to that of

the period of interruption of the buzzer. Every position of the maxima on the scale C_2 defines thus the frequency of a certain harmonic of an oscillation, whose fundamental is given by the number of the buzzer interruptions per second.

Let n be the number of the interruptions per second of the buzzer, ν_1 the natural frequency to be measured of the circuit II in a certain position of the condenser C_2' , ν_2 a higher frequency of the circuit II in another position of the condenser C_2'' , κ a number indicating which harmonic ν_1 is in relation to the fundamental n , and s the number of maximas observed while moving the condenser C_2 from the position C_2' to C_2'' :—

$$\nu_1 = n\kappa, \quad (1)$$

$$\nu_2 = n(\kappa + s). \quad (2)$$

$$\frac{\nu_1}{\nu_2} = \frac{\kappa}{\kappa + s}; \quad s = \kappa \left(\frac{\nu_2}{\nu_1} - 1 \right).$$

From (1),

$$\kappa = \frac{\nu_1}{n}, \quad s = \frac{\nu_1}{n} \left(\frac{\nu_2}{\nu_1} - 1 \right),$$

$$\nu_1 = s \cdot n \cdot \frac{1}{\left(\frac{\nu_2}{\nu_1} - 1 \right)}. \quad (3)$$

By counting the number of maximas heard in the telephone while moving the condenser C_2 from C_2' to C_2'' s is found; n can be measured by any known acoustical or optical method; it remains to find the

ratio $\frac{\nu_2}{\nu_1}$. The most practical way is to choose the second position of the condenser C_2'' , not arbitrarily, but to determine it so that the natural frequency of circuit II for that position shall be a known multiple of that to be measured (C_2'). This position can be easily found by excitation of the circuit II from a separate source of oscillations energised by an electric arc or thermo-ionic valve and containing usually harmonics of its fundamental frequency.

The absolute measurements were accomplished in the

following manner (fig. 3). [Mr. John W. Perry was kind enough to draw the figures after the author's rough sketches.—L. S.]

Fig. 3.

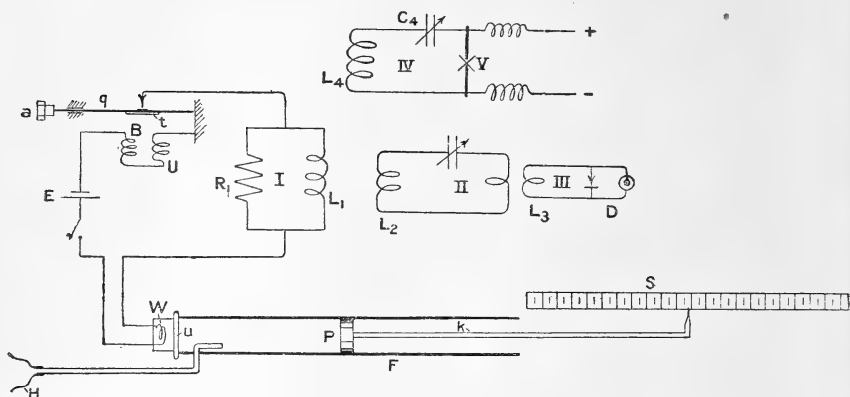

The circuit II (wave-meter) to be calibrated is placed between the aperiodic buzzer circuit I, the aperiodic indicating circuit III, and the harmonic circuit IV with its inductance L_4 and variable capacity C_4 , energised by an arc V or valve v . In the buzzer supply circuit the coil W of a telephone is inserted, the diaphragm M of which closes a tube F containing a piston P and rod K sliding over a millimetre scale S .

After the condenser C_2 of the circuit II is set in a position C_2' , for which the natural frequency is to be determined, the circuit IV is brought into resonance with it by variation of the condenser C_4 . Then the condenser C_2 is gradually turned to a position of smaller capacity C_2'' , until the indicator D (hot-wire instrument, heterodyne receiver, or ticker) again shows resonance, corresponding to the first harmonic. Thus a frequency of the circuit II twice greater than that in the position C_2' is established. The next step is to close the buzzer circuit and to count the number of maxima while turning gradually the condenser C_2 from the position C_2'' back to C_2' . Finally, the piston P is moved, the length of the tube F between the diaphragm M and piston P determined for a certain number of maximum sound intensities heard in the ear-piece H , and the wave-length in air of the sound calculated.

Thus the measurement of the natural frequency of the wave-meter II for a certain position C_2' is reduced to the measurement of a length contained between two maxima of sound intensities on the scale S. The number of interruptions of the buzzer is determined from the known relation $n = \frac{v}{\lambda}$, if v is the velocity of sound in air corrected

for the diameter of the tube used and λ the wave-length of the sound in the tube. Choosing the position C_2'' of the condenser to correspond with the first harmonic of the oscillation in position C_2' , the relation (3) is reduced to

$$v_1 = sn. \quad . \quad . \quad . \quad . \quad . \quad . \quad (4)$$

For the excitation of the circuit I a buzzer was used, the vibrating part of which consisted of a pair of steel wires q bridged by a soft iron plate t forming the armature of the electromagnet u . By means of a screw the tension of the steel wires could be regulated and the number of interruptions changed from 500 to 1500 per second.

To check the number of interruptions of the buzzer an interference method was used additionally sometimes. A telephone was connected to the secondary winding of a transformer, supplied with two primary windings—one inserted in the buzzer supply circuit, the other connected to a small alternator, generally used for telephone measurements, the speed of which could be exactly measured. By counting the number of beats per second heard in the telephone, the frequency of the buzzer circuit could be calculated.

The above method was used for calibrating and checking wave-meter standards. Wave-lengths from $\lambda = 3000$ m. to $\lambda = 20,000$, corresponding to frequencies from 100,000 down to 15,000 per sec., were measured directly by counting the number of maxima s , while shorter waves were then determined by using harmonics of resonating circuits. An accuracy of 0.5 per cent., sufficient for the purpose, was easily obtained. The buzzer could be regulated with such exactness that in continuous work during two hours and more its frequency remained practically unchanged.

To spare time necessary to find C_2'' by tuning the circuit II to the first harmonic and counting a large number of maxima between two positions of the condenser C_2 , the second corresponding to a frequency double of that of the first position, the following simplification was adopted in particular cases.

In the relation (3) $\frac{\nu_2}{\nu_1}$ can be replaced by

$$\frac{\nu_2}{\nu_1} = \frac{2\pi\sqrt{C_2' L_2}}{2\pi\sqrt{C_2'' L_2}} = \sqrt{\frac{C_2'}{C_2''}}$$

$$\nu_1 = \frac{n \cdot s}{\sqrt{\frac{C_2'}{C_2''} - 1}} \dots \dots \dots (4)$$

For the first harmonic $\frac{C_2'}{C_2''} = 4$. By the use of a calibrated variable condenser C_2 any suitable smaller relation $\frac{C_2'}{C_2''}$ can be chosen. Thus the number of maxima to be counted is reduced and the operation with the circuit IV spared.

The application of this method to closed circuits containing known capacities and inductances gave results in good agreement with those calculated by Thomson's formulæ.

The above method was also used for the exact determination of wave-lengths emitted by vertical antennae and other radiating circuits, with distributed capacity and inductance, used in radio-telegraphy.

On board the 'Lorraine,'
Aug. 30, 1919.

XXVIII. *Variably Coupled Vibrations: Gravity-Elastic Combinations. Masses and Periods equal.* By L. C. JACKSON, F.P.S.L., University College, Nottingham*.

[Plates VI. & VII.]

I. INTRODUCTION.

THE present paper is a continuation of the work of Prof. Barton and Miss Browning (Phil. Mag. vol. xxxiv. p. 246, vol. xxxv. p. 62, vol. xxxvi. p. 36) on the subject of coupled vibrations.

The coupled system treated in the following pages consists of an elastic lath pendulum and a gravity pendulum, which can be attached to the lath at different points along its length. The degree of coupling of the pendulums thus depends

* Communicated by Prof. E. H. Barton, F.R.S.

on the position of the point of suspension of the gravity pendulum*.

The paper includes 32 photographic traces of the motion of the gravity pendulum under various conditions of coupling and starting.

II. THEORY.

Equations of Motion and Coupling.

For the gravity and elastic pendulums, let the masses of the bobs be M and N , let the length of the simple pendulum equivalent to PM be r , and at time t let the linear displacements of M and N be y and z respectively; further, let the

Fig. 1.

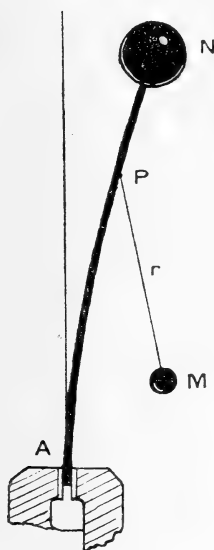

linear displacement of P be αz . It should be noted that the displacement of the bob N of the elastic pendulum has always the positive sense as shown in fig. 1.

Then for small oscillations, and considering PN as straight, the equations of motion may be written

$$M \frac{d^2 y}{dt^2} + Mg \left(\frac{y - \alpha z}{r} \right) = 0,$$

$$N \frac{d^2 z}{dt^2} + Nn^2 z = Mg\alpha \left(\frac{y - \alpha z}{r} \right).$$

* The bob of this gravity pendulum carried an electric lamp and a lens, and left on a plate below it a photographic record of its motion.

These may be re-written :

$$M \frac{d^2 y}{dt^2} + Mm^2 y = Mm^2 \alpha z, \quad \dots \dots (1)$$

$$N \frac{d^2 z}{dt^2} + (Nn^2 + Mm^2 \alpha^2) z = Mm^2 \alpha y, \quad \dots \dots (2)$$

where m and n are derived from the free isolated vibrations of M and N respectively, viz. :

$$y = a \sin mt \quad \text{and} \quad z = b \sin nt,$$

and
$$m^2 = \frac{g}{r}.$$

Following the analogy of electrical practice, we may write the coefficient of coupling γ as given by

$$\gamma^2 = \frac{Mm^2 \alpha^2}{Nn^2 + Mm^2 \alpha^2} \dots \dots (3)$$

Solution and Frequencies.

To solve (1) and (2), try in (1)

$$y = e^{xt} \dots \dots (4)$$

This gives

$$z = \frac{x^2 + m^2}{m^2 \alpha} e^{xt} \dots \dots (5)$$

Then (4) and (5) in (2) give the auxiliary equation in x :

$$Nx^4 + x^2(Nm^2 + Nn^2 + Mm^2 \alpha^2) + Nn^2 m^2 = 0. \dots (6)$$

This may be re-written in the form

$$x^4 + x^2(p^2 + q^2) + p^2 q^2 = 0. \dots (7)$$

Hence

$$x = \pm pi \quad \text{or} \quad \pm qi \dots (8)$$

From this point we shall treat the case in which $M=N$, $m=n$.

Thus the equation (3) for the coupling now reduces to

$$\gamma^2 = \frac{\alpha^2}{1 + \alpha^2}.$$

Hence, on inserting the usual constants, we may write for the general solution and its first derivatives,

$$y = E \sin (pt + \epsilon) + F \sin (qt + \phi), \dots (9)$$

$$z = -\frac{p^2 - m^2}{m^2 \alpha} E \sin (pt + \epsilon) + \frac{m^2 - q^2}{m^2 \alpha} F \sin (qt + \phi), \dots (10)$$

$$\frac{dy}{dt} = pE \cos (pt + \epsilon) + qF \cos (qt + \phi), \quad \dots \quad (11)$$

$$\frac{dz}{dt} = -\frac{p^2 - m^2}{m^2 \alpha} pE \cos (pt + \epsilon) + \frac{m^2 - q^2}{m^2 \alpha} qF \cos (qt + \phi). \quad \dots \quad (12)$$

It will be seen that these are the equations of the Cord and Lath Pendulums *, but the values of the various quantities are different, as will be seen below ; but this difference might be expected, since the elastic pendulum oscillates entirely on one side of the vertical.

From the comparison of (6) and (7), and putting $M=N$ and $m=n$, we see that

$$\left. \begin{aligned} p^2 + q^2 &= 2m^2 + m^2 \alpha^2, \\ p^2 q^2 &= m^4. \end{aligned} \right\} \dots \quad (13)$$

Eliminate q from equations (13), thus obtaining the quadratic in p^2 ,

$$p^4 - (2m^2 + m^2 \alpha^2) p^2 + m^4 = 0. \quad \dots \quad (14)$$

Thus, calling the larger root p^2 and the smaller q^2 , we have

$$p^2 = \frac{m^2 \{ (2 + \alpha^2) + [(2 + \alpha^2)^2 - 4]^{\frac{1}{2}} \}}{2}, \quad \dots \quad (15)$$

$$q^2 = \frac{m^2 \{ (2 + \alpha^2) - [(2 + \alpha^2)^2 - 4]^{\frac{1}{2}} \}}{2}; \quad \dots \quad (16)$$

whence

$$\frac{p}{q} = \frac{\{ (2 + \alpha^2) + [(2 + \alpha^2)^2 - 4]^{\frac{1}{2}} \}^{\frac{1}{2}}}{\{ (2 + \alpha^2) - [(2 + \alpha^2)^2 - 4]^{\frac{1}{2}} \}^{\frac{1}{2}}}. \quad \dots \quad (17)$$

Initial Conditions.

(i.) *Lower bob struck.*

We may here write

$$y = 0, \quad z = 0, \quad \frac{dy}{dt} = u, \quad \frac{dz}{dt} = 0 \quad \text{for } t = 0. \quad \dots \quad (18)$$

These inserted in (9) to (12) give equations satisfied by

$$\epsilon = 0, \quad \phi = 0, \quad E = \frac{(m^2 - q^2)u}{(p^2 - q^2)p}, \quad F = \frac{(p^2 - m^2)u}{(p^2 - q^2)q}; \quad (19)$$

* Phil. Mag. vol. xxxiv. no. 202, p. 260.

and these values put in (9) and (10) give the special solution

$$\left. \begin{aligned} y &= \frac{(m^2 - q^2)u}{(p^2 - q^2)p} \sin pt + \frac{(p^2 - m^2)u}{(p^2 - q^2)q} \sin qt, \\ z &= \frac{-(p^2 - m^2)(m^2 - q^2)u}{m^2\alpha(p^2 - q^2)p} \sin pt + \frac{(m^2 - q^2)(p^2 - m^2)u}{m^2\alpha(p^2 - q^2)q} \sin qt; \end{aligned} \right\} (20)$$

so

$$\frac{E}{F} = \frac{(m^2 - q^2)q}{(p^2 - m^2)p} \quad \text{and} \quad \frac{G}{H} = \frac{-q}{p}, \quad . . . (21)$$

where G and H are the quick and slow z vibrations.

(ii.) *Upper bob struck.*

Here we may write

$$y = 0, \quad z = 0, \quad \frac{dy}{dt} = 0, \quad \frac{dz}{dt} = v \quad \text{for } t = 0. \quad . (22)$$

These conditions put in (9) to (12) give equations satisfied by

$$\epsilon = 0, \quad \phi = 0, \quad E = \frac{-m^2\alpha v}{p(p^2 - q^2)}, \quad F = \frac{m^2\alpha v}{q(p^2 - q^2)}. \quad . (23)$$

So inserting these values in (9) and (10) we have the special solution

$$y = \frac{-m^2\alpha v}{(p^2 - q^2)p} \sin pt + \frac{m^2\alpha v}{(p^2 - q^2)q} \sin qt, \quad . . (24)$$

$$z = \frac{(p^2 - m^2)v}{(p^2 - q^2)p} \sin pt + \frac{(m^2 - q^2)v}{(p^2 - q^2)q} \sin qt; \quad . . (25)$$

so

$$\frac{E}{F} = \frac{-q}{p} \quad \text{and} \quad \frac{G}{H} = \frac{(p^2 - m^2)q}{(m^2 - q^2)p}. \quad . . . (26)$$

Note the contrast between (21) and (26).

(iii.) *Lower bob displaced; upper free.*

Let the displacement a of the lower bob M be produced by a horizontal force. Then the corresponding displacement z of N when at rest can be found statically. We thus obtain

$$y = a, \quad z = \frac{\alpha^2 a}{1 + \alpha^2}, \quad \frac{dy}{dt} = 0, \quad \frac{dz}{dt} = 0 \quad \text{for } t = 0. \quad . (27)$$

These conditions inserted in (9) to (12) give equations satisfied by

$$\left. \begin{aligned} \epsilon &= \frac{\pi}{2}, & E &= \frac{p^2 - q^2 + (p^2 - q^2)\alpha^2 - (2\alpha^3 + \alpha)m^2}{(1 + \alpha^2)(p^2 - q^2)} \cdot a, \\ \phi &= \frac{\pi}{2}, & F &= \frac{(2\alpha^2 + 1)(m^2\alpha)}{(1 + \alpha^2)(p^2 - q^2)} \cdot a. \end{aligned} \right\} \quad (28)$$

These values put in (9) and (10) give the special solution :

$$y = \frac{p^2 - q^2 + (p^2 - q^2)\alpha^2 - (2\alpha^3 + \alpha)m^2}{(p^2 - q^2)(1 + \alpha^2)} a \cos pt + \frac{(2\alpha^2 + 1)(m^2\alpha)}{(p^2 - q^2)(1 + \alpha^2)} a \cos qt, \dots \quad (29)$$

$$z = \frac{-(p^2 - m^2)\{p^2 - q^2 + (p^2 - q^2)\alpha^2 - (2\alpha^3 + \alpha)m^2\}}{(1 + \alpha^2)(p^2 - q^2)(m^2\alpha)} a \cos pt + \frac{(m^2 - q^2)(2\alpha^2 + 1)}{(1 + \alpha^2)(p^2 - q^2)} a \cos qt. \dots \quad (30)$$

So the ratio of the amplitudes of the quick and slow vibrations of the y and z motions are given by

$$\frac{E}{F} = \frac{p^2 - q^2 + (p^2 - q^2)\alpha^2 - (2\alpha^3 + \alpha)m^2}{(2\alpha^2 + 1)(m^2\alpha)}, \dots \quad (31)$$

$$\frac{G}{H} = \frac{-(p^2 - m^2)\{p^2 - q^2 + (p^2 - q^2)\alpha^2 - (2\alpha^3 + \alpha)m^2\}}{(2\alpha^2 + 1)(m^2\alpha)}. \dots \quad (32)$$

(iv.) *Upper bob displaced; lower bob free.*

This case may be represented by

$$y = ab, \quad z = b, \quad \frac{dy}{dt} = 0, \quad \frac{dz}{dt} = 0 \quad \text{for } t = 0. \quad (33)$$

These put in (9) to (12) give equations satisfied by

$$\epsilon = \frac{\pi}{2}, \quad \phi = \frac{\pi}{2}, \quad E = \frac{-\alpha q^2 b}{p^2 - q^2}, \quad F = \frac{\alpha p^2 b}{p^2 - q^2}. \quad (34)$$

These values in (9) and (10) give the special solution

$$\left. \begin{aligned} y &= \frac{-\alpha q^2 b}{(p^2 - q^2)} \cos pt + \frac{\alpha p^2 b}{p^2 - q^2} \cos qt, \\ z &= \frac{(p^2 - m^2) q^2 b}{(p^2 - q^2) m^2} \cos pt + \frac{(m^2 - q^2) p^2 b}{(p^2 - q^2) m^2} \cos qt. \end{aligned} \right\} \quad (35)$$

So

$$\frac{E}{F} = \frac{-q^2}{p^2} \quad \text{and} \quad \frac{G}{H} = \frac{(p^2 - m^2) q^2}{(m^2 - q^2) p^2}. \quad \dots \quad (36)$$

III. RELATIONS AMONG THE VARIABLES.

Fig. 2 is a graph showing the relation between γ and α , the couplings being ordinates and the values of α abscissæ.

The data for the graph are given in the following table:—

Coupling. per cent.	Values of α .	Frequency ratio $p : q$.
0	0	1·000
5	0·05006	1·051
10	0·1005	1·106
15	0·1517	1·121
20	0·2041	1·226
25	0·2582	1·294
30	0·3145	1·362
35	0·3737	1·475
40	0·4364	1·542
45	0·5039	1·656
50	0·5780	1·767
55	0·6586	1·910
60	0·7499	2·083
65	0·8553	2·296
70	0·9802	2·572

It will be observed that, while the general solutions for the present system are the same as those for the Cord and Lath Pendulums, the equations for the couplings are not the same, there being no term in α in the equation for the gravity-elastic arrangement.

Fig. 3 is a graph showing the relation between γ and $\frac{p}{q}$.

Fig. 2.

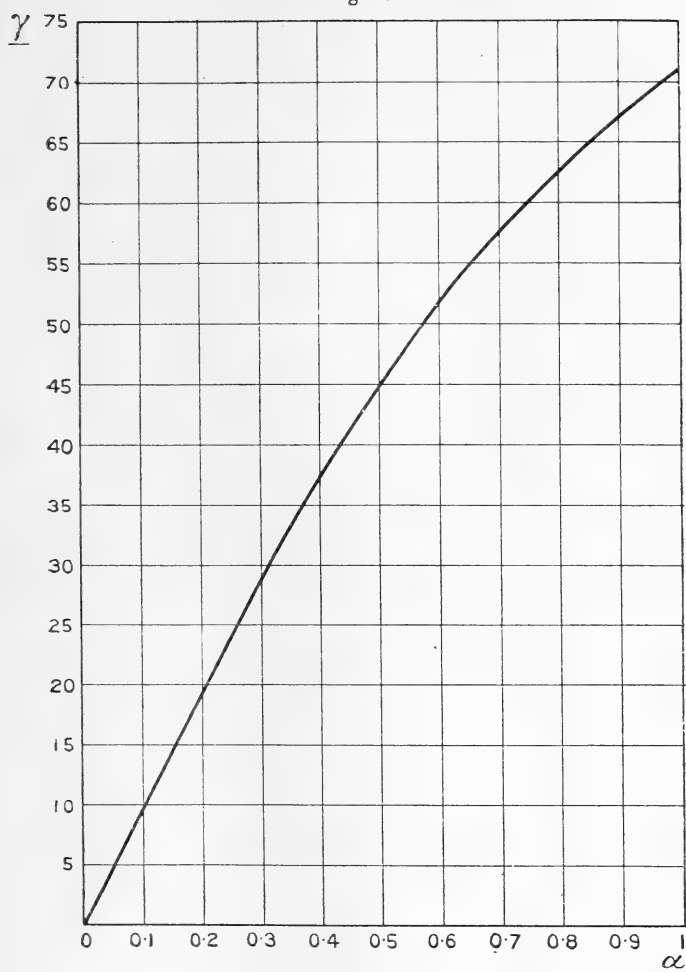

IV. EXPERIMENTAL ARRANGEMENT AND RESULTS.

The actual experimental arrangement used is illustrated in fig. 4. It consists of a lath L clamped at A and carrying a bob N. The gravity pendulum M is attached to L at P, P being movable. The bob M is of special construction. It enables a spot of light to be focussed on a naked photographic plate B, which is moved by hand in a frame between

guides perpendicularly to the motion of M , the room in which experiment is made being dark. The box part of M contains

Fig. 3.

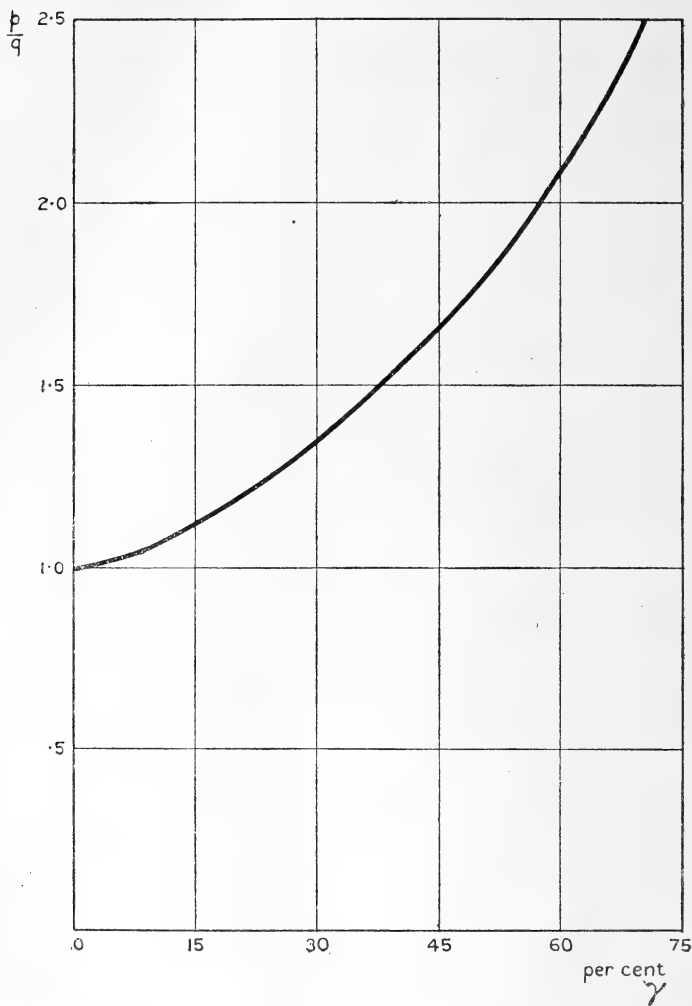

an electric battery which lights a small lamp inside C . The light then passes through a pinhole and is focussed in B by a lens in D . By this means a trace is obtained directly for the motion of M . If the apparatus is to be used for demonstration purposes for a class of students, the bob M is replaced by a funnel and sand, as in arrangements used in papers previously mentioned.

Length of lath pendulum = 100 cms.
 Length of gravity pendulum = 68.5 cms.

Fig. 4.

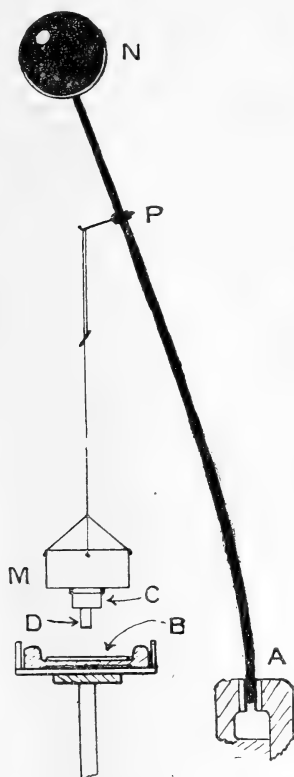

Figs. 1-32 (Pls. VI. & VII.) are photographic reproductions of traces obtained for the motion of the lower bob under various conditions.

Figs. 1-16 (Pl. VI.) are traces obtained when the upper bob was struck, the coupling ranging from 5 per cent. to 65 per cent. The first figures, *i. e.* those for the smaller couplings, show very well the phenomenon of beats and the slow surging to and fro of the energy of the bobs. The series shows in a marked manner the effect of a progressive tightening of the coupling until, in fig. 14, the case of the note and its octave (frequencies $p:q=2:1$) has been reached very nearly. It will be seen that a coupling intermediate between that of fig. 14 (58 per cent) and that of fig. 15 (62 per cent.) would give the ratio $p:q=2:1$. By comparison with the table in Section III., it will be seen that

the experimental result is in good agreement with the theory. Fig. 16 shows the effect of frequencies nearly 5:2; theory indicates that for 65 per cent. coupling $p:q=2.4:1$.

Figs. 17-24 (Pl. VII.) are traces obtained when the upper bob was displaced, the lower bob hanging free. A comparison with Pl. VI. brings out the dependence of the details of the traces on the initial conditions. Thus fig. 20 (58 per cent.) is a trace for the ratio $p:q$ nearly equal to 2:1; but the characteristic "kink" of the 2:1 curve is hardly visible, low down in the troughs of the curve. Fig. 21 (58 per cent.), on the other hand, shows the "kink" very well; but the trace is slightly distorted because the bob possessed, at the time, a small transverse motion as well as the correct longitudinal motion. Fig. 22 (approx. 59 per cent.) shows the effect of a combination of frequencies rather greater than 2:1, producing a wandering of the "kink," with a definite period up and down the main curve. The figure shows rather more than a complete cycle of this wandering.

Figs. 25-32 (Pl. VII.) are traces obtained when the lower bob was displaced, the upper bob being free. This was effected by a horizontal thread, which was burnt when all was steady.

The coupled system here described thus presents a fairly close mechanical analogy to the case of coupled electric circuits, as will be seen by the foregoing theory and experiment. On account of the simplicity of the arrangement it is a convenient model by the aid of which the somewhat abstruse subject of coupled electrical vibrations can be demonstrated to a class where visible results are needed to satisfy the non-mathematical student.

SUMMARY.

1. In the present paper the mathematical theory of a coupled system consisting of a gravity and an elastic pendulum is developed and confirmed experimentally.

2. The paper is illustrated by 32 photographic reproductions of the traces obtained for the motion of the lower bob under various conditions of starting and coupling.

3. The system here discussed gives very similar results to those previously obtained with the Cord and Lath Pendulums by Barton and Browning, and can be used as an analogy to the electrical case of circuits of equal inductances and frequencies. In this mechanical case, as in the electrical one, the motions of the components of the systems are not interchangeable.

4. It is hoped later to deal with the more general case of the same arrangement in which both masses and periods are unequal.

Physical Department,
University College, Nottingham,
June 1919.

XXIX. *On the Magnetic Susceptibilities of Hydrogen and, some other Gases.* By TAKÉ SONÉ*.

INDEX TO SECTIONS.

1. INTRODUCTION.
2. METHOD OF MEASUREMENT.
3. APPARATUS FOR MEASUREMENT.
 - (a) Magnetic balance.
 - (b) Compressor and measuring tube.
4. PROCEDURE FOR MEASUREMENTS.
 - (a) Adjustment of the measuring tube.
 - (b) Determination of the mass.
 - (c) Method of filling the measuring tube with gas.
 - (d) Electromagnet.
 - (e) Method of experiments.
5. AIR.
6. OXYGEN.
7. CARBON DIOXIDE.
8. NITROGEN.
9. HYDROGEN.
 - (a) Preparation of pure hydrogen gas.
 - (b) Filling the measuring tube with the gas.
 - (c) Results of magnetic measurement.
 - (d) Purity of the hydrogen gas.
10. CONCLUDING REMARKS.

§ 1. INTRODUCTION.

IN the electron theory of magnetism, it is assumed that the magnetism is due to electrons revolving about the positive nucleus in the atom; and hence the electronic structure of the atom has a very important bearing on its magnetic properties. The models of the atoms or molecules hitherto proposed are so constructed as to explain only the phenomena of light; but the question whether the nature of atomic or molecular magnetism, due to the system of the revolving electrons, agrees with the results of observation or not, is in most cases not touched at all. For example, Bohr's model † of hydrogen molecules explains very satisfactorily the light dispersion of hydrogen; but its magnetic polarity is paramagnetic in contradiction to the observed fact that hydrogen gas is diamagnetic. A correct theory of the constitution of the atoms or molecules must, however, not only explain the phenomena of light, but also their magnetism. In this respect, a knowledge of the magnetic susceptibility of various gases, especially those of hydrogen

* Communicated by the Author.

† N. Bohr, *Phil. Mag.* xxvi. p. 857 (1913); P. Debye, *Sitz. d. math.-phys. Klas. d. Akad. d. Wissensch. München*, p. 1 (1915).

and helium, is very important. In spite of this fact, owing to the great difficulty in measuring the susceptibility of gases, only a few cases—oxygen and air—are known, in which the value of susceptibility can be given with fair accuracy. For other gases the values of susceptibility by different observers show large discrepancies not only in magnitude, but sometimes in sign. Hence an exact and more extended determination of the magnetic susceptibility of different gases was thought to be desirable. The present investigation was undertaken at the suggestion of Professor K. Honda about two years ago and is still in progress.

On the other hand, the theory of magnetization of the gases has been successfully developed by P. Langevin* ; the conclusions arrived at agree in many points with the observed facts ; but there are many others which cannot be explained by his theory. According to him, the molecules of a paramagnetic gas have each a definite magnetic moment, which is comparable with that of a ferromagnetic substance, but those of a diamagnetic gas have no magnetic moments, so that there is a fundamental distinction between paramagnetic and diamagnetic substances. The diamagnetism is of an atomic nature and therefore cannot vary with temperature, or by the change of states, or by any mode of chemical combination. These conclusions do not, however, accord with the fact that the susceptibility-atomic weight curve for elements† changes quite continuously in passing from the paramagnetic elements to the diamagnetic, and that the susceptibility of tin ‡ changes its sign at the transformation point and during melting. Professor K. Honda§ modified Langevin's theory of paramagnetic and diamagnetic gases so as to include the magnetization of liquid and solid states, and gave a different aspect to the distinction between paramagnetic and diamagnetic substances. According to him the observed susceptibility χ is the sum of the Langevin paramagnetic and diamagnetic susceptibilities χ_p and χ_d ; that is

$$\chi = \chi_p + \chi_d,$$

which may be paramagnetic or diamagnetic, according as

$$\chi_p > \chi_d.$$

Since χ_p depends on the configuration of the atoms in a

* P. Langevin, *Ann. de chim. et de phys.* viii, p. 70 (1905).

† K. Honda, *Ann. d. Phys.* xxxii, p. 1027 (1910).

‡ K. Honda, *loc. cit.*

§ K. Honda, *Sci. Rep.* iii, p. 171 (1914).

molecule, it may change with temperature, or by the change of states, etc.; and hence the observed susceptibility χ may change in a similar way, as actually observed. The continuous change of the susceptibility-atomic weight curve from the paramagnetic elements to diamagnetic above referred to is also explained on the same basis.

According to the above theory, the molecules of a paramagnetic substance must therefore possess a definite magnetic moment, while those of a diamagnetic substance have only a small magnetic moment or none. In Bohr's model of a hydrogen molecule, χ_p is decidedly greater than χ_d^* , and therefore χ or $\chi_p + \chi_d$ is positive in contradiction to the observed fact.

In a recent paper, Professors Honda and Ôkubo † proposed a new theory of magnetization of the gases. According to the kinetic theory of gases, besides translational motions, the molecules of a gas are continuously making rotational motions about their centres of mass; and in their theory, these molecules are treated as gyroscopes. Since the axis of rotation of the molecules does not in general coincide with the magnetic axis, the magnetic moment of the molecules is supposed to be resolved in the direction of the axis of rotation and that perpendicular to it. Under the action of a magnetic field, the paramagnetic polarization results from the former component and the diamagnetic polarization from the latter, and therefore a resultant polarization is the sum of these two. The resultant may be positive or negative, according as

paramagnetic polarization \geq diamagnetic polarization.

The theory proves that the sign of the magnetization of a gas depends on the shape of the molecules, and not in the least on their magnetic moment. In fact, a gas whose molecules have a definite magnetic moment comparable with those of iron may be diamagnetic, provided the axis of rotation is perpendicular to the magnetic axis. This kind of diamagnetism is not dealt with in any of the previous theories. In order to test these theories it is necessary to have the correct values of susceptibility of different gases, which are at present scarcely known.

One of the chief difficulties which we encounter in the determination of the magnetic susceptibility of gases, lies in the preparation of pure gases, *i. e.* those which are perfectly

* J. Kunz, Phys. Rev. xii. p. 59 (1918).

† K. Honda and J. Ôkubo, Sci. Rep. vii. p. 141 (1918); Phys. Rev. viii. p. 6 (1919).

free from air, and the other in the extreme smallness of the volume susceptibility of gases. In the present research I paid special attention to the preparation of pure gases, the removal of the air contained in the generators and purifiers being the constant object of my endeavour. As for the measurement of the magnetic susceptibility, I succeeded in overcoming the difficulty by constructing an apparatus, by means of which I could seal gases in a glass tube at a very high pressure without the least fear of leakage. This apparatus enabled me to use in each case a quantity of gas sufficient for the determination of its magnetic susceptibility and density. A special magnetic balance of high sensibility was constructed for measuring the magnetic force acting on the gas which was sealed in the glass tube and placed in a strong magnetic field. The details of the method and the arrangement of the experiments are given in the following pages.

§ 2. METHOD OF MEASUREMENT.

The method of measurement is based on the following principle:—A cylindrical rod made of the material to be tested is vertically suspended between the horizontal pole-pieces of an electromagnet from an arm of a magnetic balance specially constructed, the lower end of the rod being placed in the axial line of the pole-pieces and the upper end in a place where the magnetic field is negligibly small.

Suppose at first the balance to be in equilibrium, with no magnetic field acting on it, by applying the field the rod is supposed to undergo a slight upward displacement δa , but in equilibrium acted on by a force f arising from an inclination of the balance beam.

Then this force is just equal to the lifting force due to the magnetic field H . The work done by the force is equal to the change of the magnetic energy of the rod, that is

$$f\delta a = \frac{\kappa - \kappa'}{2} H^2 S \delta a,$$

where S is the cross-section of the rod, κ and κ' are the susceptibilities of the test specimen and the surrounding medium respectively.

Fig. 1.

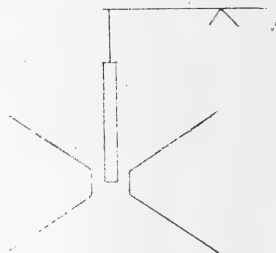

Hence
$$f = \frac{\kappa - \kappa'}{2} H^2 S,$$

or
$$\kappa - \kappa' = \frac{2f}{H^2 S}.$$

The force f is measured by a small deflexion of the balance beam, which causes a vertical rotation of a small mirror suspended by a bifilar system, the upper ends of the fibres being attached to the lower end of the pointer and to a fixed stand. This rotation of the mirror is measured as usual by a scale and telescope. The above method is due to Lord Kelvin.

For a very small displacement of the suspended tube the force is proportional to δa , and consequently to the deflexion of the scale δ ; hence c being a proportional constant, we get

$$f = c\delta.$$

Introducing this relation into the expression for $\kappa - \kappa'$, we get

$$\kappa - \kappa' = \frac{2c\delta}{H^2 S}.$$

If the intensity of the field remains constant in the range of the displacement, the factor $\frac{2c}{H^2 S}$ is also constant. Let p denote this factor, then the above expression becomes

$$\kappa - \kappa' = p\delta.$$

In the present experiment the measurements of the susceptibilities of the gases were always made relatively to water or to air; that is, for the case of air, the comparison was made with distilled water, while for other gases the comparison was always made with dry air. In the present day the susceptibility of pure water* is accurately known, its value -0.720×10^{-6} was assumed in the present experiment. The susceptibility of air was determined relatively to water.

The upper half of a glass tube separated by a glass partition in the middle was filled with the gas or liquid under examination, while the air in the lower half of the tube was evacuated and its lower end sealed. The tube was then vertically suspended from the arm of the balance

* P. Sève, *Jour. d. Phys.* (5) iii. p. 8 (1913); de Haas u. Drapier, *Ann. d. Phys.* xlii. p. 673 (1913); A. Piccard, *Arch. de Genève*, xxxv. p. 209 (1913).

between the pole-pieces of a Weiss electromagnet, the upper surface of the partition being placed on the axial line of the pole-pieces (fig. 2). The field was then applied and the corresponding deflexion of the scale observed. Since the tube alone produced some deflexion of the scale it was necessary to eliminate the effect by making two similar observations, first after evacuating the upper half, and secondly after filling it with distilled water.

Fig. 2.

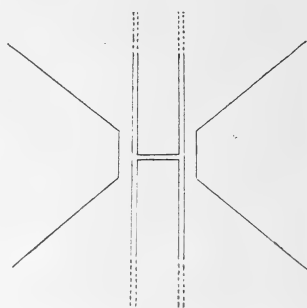

If the virtual susceptibility of the system below the glass partition be denoted by κ' , we have the following relations for the three cases, when the upper half of the tube is evacuated, and when it is filled with the gas to be tested and with water respectively :

$$\kappa_o - \kappa' = p \delta,$$

$$\kappa_g - \kappa' = p \delta_g,$$

$$\kappa_w - \kappa' = p \delta_w,$$

where κ_o , κ_g , and κ_w denote the susceptibilities of the empty space, the gas, and water respectively, and δ_o , δ_g , and δ_w are the corresponding deflexions of the scale.

Eliminating κ' from these equations and putting κ equal to zero, we get the following relation between the susceptibilities of the gas and water :

$$\frac{\kappa_g}{\kappa_w} = \frac{\delta_g - \delta_o}{\delta_w - \delta_o}.$$

In the actual case, since the glass tube is not placed in a perfectly symmetrical position with respect to the axial line of the pole-pieces, the term κ_o is not zero though it is a small quantity, and it is the susceptibility due to the glass tube itself. In the terms δ_g and δ_w , the above quantity κ_o due to the glass tube is involved, and the differences $\delta_g - \delta_o = d_g$ and $\delta_w - \delta_o = d_w$ are the true deflexions due to the glass and water respectively. And finally we get

$$\frac{\kappa_g}{\kappa_w} = \frac{d_g}{d_w}.$$

If the densities of the gas and water be respectively ρ_g

and ρ_w , we have for the ratio of the specific susceptibilities χ_g and χ_w of these two substances

$$\frac{\chi_g}{\chi_w} = \frac{d_g/\rho_g}{d_w/\rho_w}$$

or $= \frac{d_g/m_g}{d_w/m_w},$

where m_g and m_w are the total masses of the gas and water occupying the same volume of the tube respectively. The same formula may also be used when water is replaced by air, in which case we obtain the susceptibility of a gas relative to air.

§ 3. APPARATUS FOR MEASUREMENT.

(a) Magnetic Balance.

The magnetic balance and its accessories used in measuring the magnetic susceptibilities of several gases are diagrammatically shown in fig. 3.

Fig. 3.

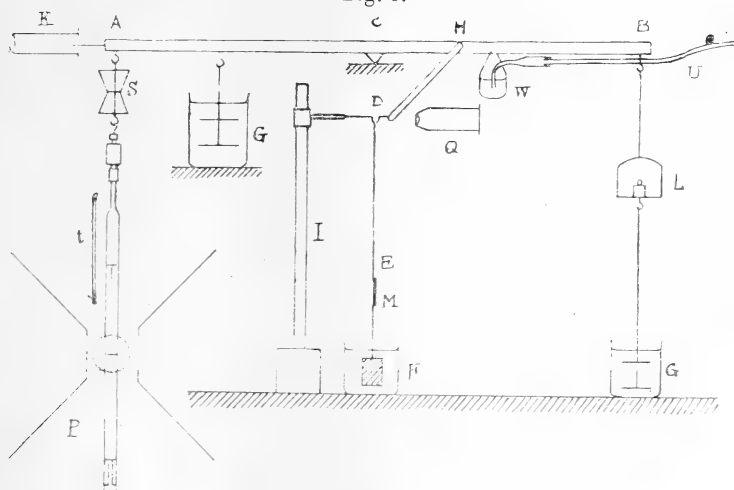

AB is an aluminium arm of the magnetic balance, 80 cm. long, C an agate knife-edge resting on a smooth plane of steel, and HD an aluminium pointer, a similar counterpoise being attached to the same arm, but on the opposite side of the beam. DE shows the side view of the bifilar system

consisting of two Wollastone wires 0.015 mm. thick, M is a small mirror attached to the lower end of the bifilar system and facing at right angles to the plane of the figure, and F a copper vane damper dipped in vessel containing a mixture of petroleum and machine oil. I is a rectangular brass pillar with a slide-arm carrying a fixed suspension of the bifilar system. Q is a Quincke microscope with an ocular micrometer whose smallest division corresponds to $1/60$ mm. With the microscope the breadth of the bifilar on its upper end can be observed. S is a trifilar system consisting of two horizontal Y-shaped wooden frames with a small aluminium Y between them, these frames being connected by three fine copper wires, as shown in fig. 4. The aluminium frame can be moved upwards or downwards, so that one can make a minute adjustment of the height of the suspended tube. T is the measuring tube suspended between the pole-pieces of a Weiss electromagnet of intermediate size. *t* is a thermometer placed near the measuring tube to determine the temperature of the specimen under examination. P is a microscope (shown in section) readable to 0.005 mm., with which one can adjust the measuring tube to a correct position. K is a collimator tube of a spectroscope used for the purpose of clamping the arm of the balance by means of its vertical slit. This is necessary when it is required to take the measuring tube away from the arm, or when the tube is to be adjusted to a correct position by means of the trifilar system without giving the least disturbance to the balance. L is a pan in which a balancing weight is to be placed, and G a metal damper dipped in a vessel of machine oil. W is a glass cup containing water, into which is dipped a fine glass tubing, connected with a fine copper tube U, both being filled with water.

Fig. 4.

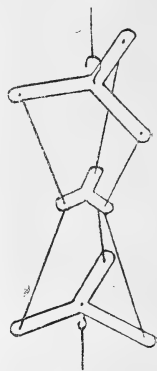

The whole arrangement was set upon a stone foundation and covered with a case to prevent the disturbances due to air currents. The case has a large glass window, through which we could observe the deflexion of the mirror with a scale and telescope. To make the finer adjustment of the orientation of the mirror from outside, an arrangement shown in fig. 5 was used.

AB is a kind of reservoir made of glass filled with water and mercury; the left end of this reservoir is connected with the copper tube U described above and the other end

with a fine capillary tube C, 0.1 mm. in diameter through a three-way-cock. One of the three ways is connected with a mercury reservoir D, and to the left end of the capillary

Fig. 5.

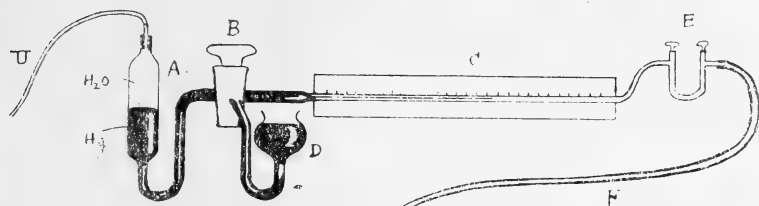

tube, a calcium chloride tube with a long rubber tubing is connected. By this arrangement we can pour into or draw out any desired quantity of water from the glass cup W shown in fig. 3, by forcing the air or sucking it at the end of the rubber tubing F. The reservoir D serves in the case, when a large quantity of water is desired to be supplied or extracted from the cup.

(b) *Compressor and Measuring Tube.*

The compression of the gas was made with a Cailletet hydraulic compressor of an ordinary type. The compressing cylinder was replaced by a cast-iron cylinder, specially designed for the present purpose and having a capacity of 1300 c.c. The pressure-gauge was also replaced by another capable of measuring up to 70 atmospheres and graduated to one atmosphere.

The glass tube, in which the gases are to be filled at a high pressure, has the following construction (fig. 6):—

The mechanism of the valve of the measuring tube is similar to that of the pressure-gauge commonly used for compressed-gas-bombs. A is a hollow brass cylinder having two bores in it, a narrow straight hole, 1 mm. wide, is bored through from the left end to the central hole terminating in a cone. In this hole a small brass cylinder P lightly fitted to the hole is pressed on a rubber plate on the right end of the hole by a weak spring. On the left end of this cylinder P, a small piece of ebonite is imbedded. The right opening of the cylinder A is provided with a cup C, which can be screwed into the cylinder, till it firmly presses the rubber plate covering the right opening of the central hole with a thin metal ring. Within the cup C, there is a piece of

metal Q which can be moved smoothly along the axis of the cup by means of a screw E. To the left end of the cylinder A, a brass piece B, and to its lateral surface, another piece D is screwed in. The former piece is tightly connected with the measuring tube, and the latter with the glass tube forming the projecting neck of the compressing cylinder.

Fig. 6.

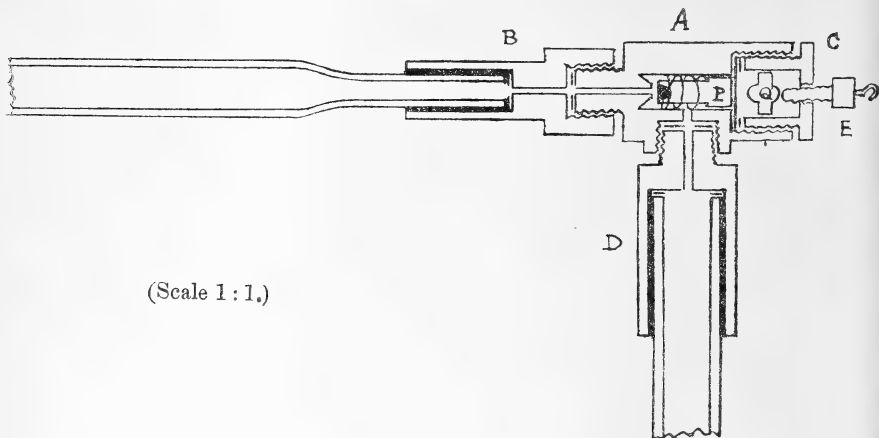

(Scale 1 : 1.)

This connexion between the glass tubes and the brass pieces is made airtight by sealing-wax mixed with a small quantity of linseed oil. In order to prevent the flowing of wax into the interior of the tube, when melted wax is poured into the interspace between the brass piece and glass tube, a thin rubber plate is placed at the end of the glass tube. All the packings for the screws are made of thick lead plates.

If the measuring tube with the brass pieces are connected with the compressing cylinder by means of the screw D and the inside air is evacuated by a pump connected with the compressing cylinder, the piston P is displaced to the right by a spring, so that the interior of the glass tube and of the cylinder A communicate with each other. If after the gas is compressed into the measuring tube, the screw E is turned and the piston P made to press on the rubber plate, the piston tightly closes the left hole of the cylinder A. The screw D is then disconnected, and now the measuring tube with the compressed gas inside can be suspended from the beam of the magnetic balance between the pole-pieces of the electromagnet for the determination of the susceptibility of the gas.

If the volume of the compressed gas is to be measured, a screw-head similar to D with a short piece of glass tube is screwed in the side hole; this tube is then placed under a receiving vessel for the gas. By turning the screw E very slowly, the compressed gas can be let into the receiving vessel.

§ 4. PROCEDURE FOR EXPERIMENTS.

(a) *Adjustment of the Measuring Tube.*

The position of the measuring tube suspended from the beam of the balance was accurately determined by means of the microscope. The forward or backward displacement of the tube from the central line joining the centres of the pole-pieces was adjusted with an accuracy of 0.1 mm. by aid of the lines marked on the pole-pieces. The height of the tube could easily and quickly be adjusted by means of the trifilar suspension system, with an accuracy of 0.05 mm. The breadth of bifilar carrying the mirror was observed with a Quincke microscope and adjusted with an accuracy of 0.01 mm. The distance of the mirror from the scale and telescope was 190 cm. When the breadth of the bifilar suspension was 0.3 mm. the deflexion of one scale-division corresponded to a vertical displacement of the measuring tube by about 1×10^{-3} mm.

(b) *Determination of the Mass.*

The mass of the gases subjected to the experiment was determined by two different methods and the results compared with each other. The first method was to determine the mass directly by weighing, that is, from the difference of weights, first when the tube was filled with the compressed gas under examination, and afterwards when it was evacuated. The evacuation was always made after the tube was repeatedly filled and evacuated several times with pure hydrogen by means of a Gaede auxiliary pump, and then the weighing was conducted with the utmost care. The second method was to determine the mass by measuring the volume of the gas collected in an eudiometer. Knowing the pressure and temperature of the gas, we calculated the volume of the gas at the standard pressure and temperature, and by multiplying the density of the gas at the standard conditions by the volume thus obtained, the mass of the gas was obtained. These two methods were used in most of the experiments and the results were found to agree very satisfactorily with each other. But, for the reduction of the observed results, either

of these results was used according to the kind of gases under examination. Thus the mass of carbon dioxide was always determined by the weighing method, and that of hydrogen chiefly by the volumetric method. The mass of air sealed in the measuring tube at the atmospheric pressure and temperature was obtained by calculation, the conditions of the atmospheric air and the volume of the tube in which it was sealed being known. The volume of the measuring tube was accurately determined by filling it with mercury.

(c) *Method of filling the Measuring Tube with Gas.*

The measuring tube is connected with the neck of the compressing cylinder E by means of a screw D (fig. 7).

Fig. 7.

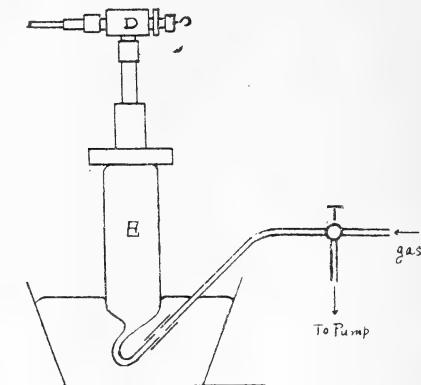

The lower end of the glass cylinder E is bent upward, and connected by a short rubber tube with a glass tube coming from a three-way-cock T. One of the three ways communicates with a Gaede auxiliary pump and another with the gas generator or reservoir. The lower part of the cylinder E is dipped in a mercury bath as shown in fig. 7. By means of the three-way-cock, the cylinder is first connected with the pump, evacuated, and then the cock is turned, the gas is introduced into the cylinder. Next the cylinder is again evacuated and the gas introduced; these processes are usually repeated four or five times. Then the air previously contained in the cylinder is removed, and the cylinder now contains the pure gas at a pressure of about one atmosphere. Then the cylinder E and the glass tube are disconnected under the surface of the mercury in the bath.

A quantity of mercury then flows into the cylinder and partially fills the bottom of it. In this state the cylinder is transportable to the Cailletet compressor without any risk of introducing other gases into it.

(d) *Electromagnet.*

The magnetic field was obtained by a Weiss electromagnet, the pole-pieces being always 1 cm. apart. The end surface of the pole-pieces was a circular section of 1 cm. in diameter. The magnetizing current of 10 amperes produced a field of 22,000 gauss in the place where the magnetic measurement was to be made. In the case of air 4 amperes were used and the corresponding field 12,500 gauss. During the magnetization a slight convection of air was produced by the heating of the electromagnet, and this made the observation of the deflexion of the mirror somewhat difficult. To avoid the disturbing effect the coil of the magnet with the exception of the pole-pieces was entirely covered with a winding of lead tubing and the water mantles, water being constantly circulated through the lead tubing and mantles during the observations.

The intensity of the field was measured by means of an exploring coil and a ballistic galvanometer as usual.

(e) *Method of Experiments.*

In the magnetic balance a delicate knife-edge rests on a smooth steel plane, so that a very minute gradual displacement of the knife-edge, either translational or rotational, can never be absolutely avoided. This gradual displacement is usually accelerated when the field was repeatedly applied, causing the gradual displacement of the zero point on the scale. However, by comparing the results obtained when such a gradual displacement of the zero-point occurred and when it was absent, it was found that this displacement did not affect the final results, provided the mean of the successive zero-points in each observation be taken as the true zero of the deflexion.

In making the observations, we first passed a current of 10 amperes in the electromagnet, and the maximum deflexion of the scale was observed. It took usually 30 to 60 seconds. Then the current was quickly reduced to zero, and the final deflexion or the zero-point was observed. These processes were repeated usually ten times, and the mean of these deflexions was taken. The whole process required about ten minutes. The temperature of the gas under examination

was carefully observed at each set of observations with a thermometer suspended near the measuring tube in the space between the poles of the electromagnet. A current of water was constantly passed around the electromagnet during the observation.

§ 5. AIR.

The magnetic susceptibility of the atmospheric air has been determined by many investigators, such as Faraday, Becquerel, Quincke, and more recently by Curie. But other investigators such as Du Bois, Hennig, and Piccard, have deduced the susceptibility of air from that of oxygen by neglecting the susceptibilities of nitrogen and other gases present in the atmosphere.

In the following table, the values of the volume susceptibility of air and also the ratio of the susceptibilities of air and oxygen in four cases, in which the susceptibilities were independently determined, are given :—

TABLE I.

Date.	Observer.	$\kappa_a \cdot 10^6$.	t .	κ_a/κ_{O_2} .
1853	Faraday*	0.024	...	0.184
1855	Becquerel †	0.025	...	0.208
1888	Quincke ‡	0.032	16°	0.248
1895	Curie §	0.027	20°	0.232
1888	Du Bois	0.024	15°	...
1893	Hennig ¶	0.024	25°	...
1913	Piccard **	0.029	20°	...

* M. Faraday, *Exp. Res. of Elec.* (3) p. 502.

† E. Becquerel, *Ann. de Chim. et de Phys.* (3) xliv. p. 223 (1855).

‡ G. Quincke, *Wied. Ann.* xxxiv. p. 401 (1888).

§ P. Curie, *Journ. de Phys.* iv. p. 197 (1895).

|| H. Du Bois, *Wied. Ann.* xxxv. p. 137 (1888).

¶ R. Hennig, *Wied. Ann.* l. p. 485 (1893).

** A. Piccard, *Arch. de Genève*, xxxv. p. 458 (1913).

In the above table we see that the magnetic susceptibility of air as obtained by several observers shows a large discrepancy, and also the ratio of the susceptibilities of air and oxygen directly determined is not constant. Hence it is to be concluded that the susceptibility of air and its relation to that of oxygen are not yet correctly known.

In the present research the susceptibility of the atmospheric air was determined relatively to that of redistilled water. The air to be examined was introduced into the compressing cylinder after passing through the tubes containing solid potassium hydroxide, calcium chloride, phos-

phorus pentoxide, and cotton; thus the air in the cylinder was entirely free from carbon dioxide, moisture, and dust. The air was then compressed into the measuring tube at a pressure of about 30 atmospheres and subjected to the magnetic measurement. The masses of the gas and the water were determined by weighing. In this case the magnetizing current was usually 4 amperes, and the breadth of the bifilar 1 mm.; but by changing the bifilar distance and applying a weaker or stronger field, a moderate deflexion of the scale could be obtained. In the following table one set of observations is shown as an example:—

TABLE II.

Sept. 5, 1918.					
AIR ($p=30$ atm.)			VACUUM.		
1 ^h 50 ^m P.M., $t=24^{\circ}5$ C., $b=60$ 0.			2 ^h 35 ^m P.M., $t=24^{\circ}8$ C., $b=60$ 0.		
$m_a+m_o=89\cdot0927$ gm.			$m_o=88\ 9438$ gm.		
C.	S.	δ .	C.	S.	δ .
amp.	cm.	cm.	amp.	cm.	cm.
0	56.90	17.55	0	39.40	0.15
4	74.45	17.79	4	39.55	0.35
0	56.75	17.55	0	39.20	0.20
4	74.30	17.60	4	39.40	0.20
0	56.70	17.60	0	39.20	0.20
4	74.30	17.70	4	39.40	0.24
0	56.60	17.60	0	39.16	0.24
4	74.20	17.70	4	39.46	0.20
0	56.50	17.62 (mean)	0	39.20	0.22 (mean)
WATER.					
3 ^h 35 ^m P.M., $t=24^{\circ}2$ C., $b=60$ 0.			CALCULATION.		
$m_w+m_o=93\cdot1178$ gm.			$d_a=17\cdot62-0\cdot22=17\cdot40$ cm.,		
C.	S.	δ .	$d_w=-14\cdot64-0\cdot22=-14\cdot86$ cm.,		
amp.	cm.	cm.	$m_a=0\cdot1489$ gm., $m_w=4\cdot1740$ gm.,		
0	61.29	-14.59	$\chi_a=\frac{17\cdot40}{0\cdot1489}=1169$ K,		
4	46.70	-14.70	$\chi_w=\frac{-14\ 86}{4\cdot1740}=3\cdot562$ K,		
0	61.40	-14.69	$\frac{\chi_a}{\chi_w}=\frac{1169}{3\cdot562}=328\cdot0$,		
4	46.71	-14.79	$\chi_a=23\cdot60\times 10^{-6}$.		
0	61.42	-14.56			
4	46.86	-14.56			
0	61.42	-14.62			
4	46.80	-14.70			
0	61.50	-14.64 (mean)			

In the above table b is the breadth of the bifilar expressed in the scale division in the ocular micrometer, 60 divisions corresponding to 1 mm. m_o , m_a , and m_w are the masses of oxygen, the tube evacuated, and the water respectively.

d_{O_2} and d_w are the deflexions of the scale due to oxygen and water respectively. C is the magnetizing current, S the scale reading, and δ the deflexion of the scale. K is a constant which depends on the sensibility of the apparatus and the intensity of the field.

Fifteen sets of such observations were made at a mean temperature of about $25^\circ C.$; reducing these observations to $20^\circ C.$ by assuming Curie's law, we obtain the following result:—

$$10^6 \cdot \chi_a = 23.95, 23.52, 24.20, 23.58, 23.58, 24.15, \\ 23.69, 24.04, 23.65, 24.37, 23.81, 23.42, \\ 24.06, 23.66, \text{ and } 24.13,$$

the mean value is then

$$\chi_a = 23.8_5 \times 10^{-6} \text{ at } 20^\circ C.$$

with a mean error of $\pm 0.07 \times 10^{-6}$.

Multiplying the density of air at $20^\circ C.$ and 760 mm. pressure, we get as the magnetic susceptibility per unit volume of dry air at $20^\circ C.$ and at the normal pressure,

$$\kappa_a = 0.0287_3 \times 10^{-6} \pm 0.00009 \times 10^{-6}.$$

§ 6. OXYGEN.

Oxygen is the only gas whose magnetic susceptibility has been determined with a fair accuracy; yet the values obtained by different observers differ so widely from each other that the extreme values deviate from the mean by more than 10 per cent.

The following table contains the values which have been determined by several investigators:—

TABLE III.

Date.	Observer.	$\kappa_{O_2} \cdot 10^6$.	t .
1853	Faraday *	0.143	...
1855	Becquerel †	0.149	..
1888	Quincke ‡	0.129	16°
1888	Du Bois §	0.117	15°
1893	Hennig	0.120	25°
1895	Curie ¶	0.115	20°
1913	Piccard **	0.141	20°
1916	Roop ††	0.146	16°

* M. Faraday, *loc. cit.*

|| R. Hennig, *loc. cit.*

† E. Becquerel, *loc. cit.*

¶ P. Curie, *loc. cit.*

‡ G. Quincke, *loc. cit.*

** A. Piccard, *loc. cit.*

§ H. Du Bois, *loc. cit.*

†† W. P. Roop, *Phys. Rev.* vii. p. 529 (1916).

In the present experiments the pure oxygen was obtained

by the decomposition of a solution of potassium hydroxide by electrolysis. The electrodes were of sheet nickel attached to stout nickel rods, the strength of the solution being two normal. The cell consisted of two concentric glass cylinders, the inner one having no bottom; one of the electrodes was placed in the inner cylinder and the other placed in the space between these two cylinders. The current density was 0.05 ampere per sq. cm. The generated gas was collected in a large glass reservoir by replacing water. Before introducing the gas into the measuring tube, the gas was purified by passing through bottles and tubes containing strong sulphuric acid, solid potassium hydroxide, and phosphorus pentoxide.

The susceptibilities of the gas thus purified and the air treated likewise, as described in the last Section, were compared at the ordinary temperature and pressure; the ratio of the mass of the gases being determined by calculation by knowing the temperature and pressure of the atmosphere at the time of filling the gases in the measuring tube.

In the following table an example of the results of the measurement is shown:—

TABLE IV.

March 19, 1918.			AIR.		
VACUUM.			$(t=12^{\circ}9\text{ C.}, p=748.0\text{ mm.}, t=13^{\circ}5\text{ C.})$		
$7^{\text{h}} 15^{\text{m}} \text{ P.M.}, t=15^{\circ}5\text{ C.}, b=20.0.$			$7^{\text{h}} 45^{\text{m}} \text{ P.M.}, t=15^{\circ}3\text{ C.}, b=20.0.$		
C.	S.	δ .	C.	S.	δ .
amp.	cm.	cm.	amp.	cm.	cm.
0	41.50	10.70	0	50.75	22.90
10	52.20	10.20	10	73.65	22.40
0	42.00	9.60	0	51.25	22.30
10	51.60	10.30	10	73.55	22.75
0	41.30	10.10	0	50.80	22.60
10	51.40	10.40	10	73.49	22.40
0	41.00	10.22 (mean)	0	51.00	22.56 (mean)
O ₂ .			CALCULATION.		
$(t=13^{\circ}1\text{ C.}, p=748.0\text{ mm.}, t=13^{\circ}5\text{ C.})$			$d_{O_2}=69.89-10.22=59.69\text{ cm.},$		
$7^{\text{h}} 55^{\text{m}} \text{ P.M.}, t=14^{\circ}75\text{ C.}, b=20.0.$			$d_a=22.56-10.22=12.34\text{ cm.},$		
C.	S.	δ .	$\left(\frac{\chi_{O_2}}{\chi_a}\right)_{20^{\circ}\text{ C.}} = \frac{59.67}{12.34} \times \frac{0.001210}{0.001335} \times \frac{287.3}{288.3}$ $= 4.365.$		
amp.	cm.	cm.			
0	13.60	72.00	$(\chi_{O_2})_{20^{\circ}\text{ C.}} = 104.1_2 \times 10^{-6}.$		
10	85.60	69.20			
0	16.40	69.00			
10	85.40	69.50			
0	15.90	69.30			
10	85.20	69.80			
0	15.40	70.15			
10	85.55	70.15			
0	15.40	69.89 (mean)			

Eight sets of such observations made at various temperatures ranging from 14° C. to 18° C. give the following values of the susceptibility of oxygen, which are all reduced to the value at 20° C.

$10^6 \cdot \chi_{O_2} = 104.00, 104.48, 104.00, 104.10, 103.89, 104.12, 104.60,$ and 103.86 , the mean of which is

$$\chi_{O_2} = 104.1 \times 10^{-6} \text{ at } 20^\circ \text{ C.},$$

the mean error being $\pm 0.09 \times 10^{-6}$. Multiplying the density of oxygen at 20° C. and 760 mm. pressure, we get as the susceptibility of oxygen gas per cubic centimetre,

$$\kappa_{O_2} = 0.138_6 \times 10^{-6} \pm 0.0001 \times 10^{-6}.$$

The above result is in fair agreement with Piccard's value, which seems to be the most reliable among the values of the previous investigators, but as he used a commercial oxygen, the error which might arise from the impurity of the gas would probably make the mean error of his result larger than he had believed. He also determined the mass of the gas by the absorption method, which is accompanied by some uncertainty. In the present case the gas was obtained by electrolysis and carefully purified, so that there is no uncertainty about its purity. At any rate the error in my case, if there is any, may arise from the determination of the susceptibility.

If the magnetism of air is due solely to that of oxygen present in it, the ratio of the specific susceptibilities of air and oxygen should be identical with the ratio of the mass of the oxygen in air to the total mass of air, that is, the ratio

$$\frac{\chi_a}{\chi_{O_2}} = \frac{23.85}{104.1} = 0.2291$$

must be equal to 0.2315, the difference being 0.0024.

The difference amounts to about 1 per cent. of the total value and is certainly beyond the experimental errors of the measurements of the susceptibilities. The explanation for this discrepancy will be given later on.

§ 7. CARBON DIOXIDE.

About ten years ago Professor K. Honda* found an anomalous behaviour of tin in that its magnetic property

* K. Honda, *loc. cit.*

changes from a paramagnetic to a diamagnetic during melting. Since that time no other substance showing a similar change has been found. Meantime Mr. T. Ishiwara in our laboratory found in the course of his researches on the magnetic susceptibility of chemical substances at low temperatures, that solid carbon dioxide has a diamagnetic susceptibility per unit mass of $\chi = -0.42 \times 10^{-6}$ in the temperature range between -100°C . and -170°C .

In the literature we have only a few data for the magnetic susceptibility of the gaseous carbon dioxide. The earlier investigators, such as Faraday * and Becquerel †, agreed in the view that the magnetism of gaseous carbon dioxide is too weak to be detected by their experiments. Quincke ‡ found, however, that its specific susceptibility is $\chi = +0.017 \times 10^{-6}$; more recently Bernstein § found its volume susceptibility to be $\kappa = +0.0002 \times 10^{-6}$. If these two results be true, at least in sign, then gaseous carbon dioxide is paramagnetic, and we have, besides tin, one more example of a magnetically anomalous substance. In this respect an exact determination of the susceptibility of the gaseous carbon dioxide seemed very interesting.

In the present experiment the carbon dioxide was obtained by the reaction of dilute hydrochloric acid on calcium carbonate. Pieces of pure marble previously boiled in hot water for about 24 hours in order to drive off the air occluded, were put in a Kipp apparatus with boiled distilled water, care being taken not to expose the pieces to the air. No air bubble was allowed to remain in the bottle. Then the strong hydrochloric acid was poured into the apparatus through the upper opening, and at the same time, by expelling the water from the exit, we could easily replace the water with hydrochloric acid of a moderate strength without introducing any trace of air into the apparatus. By this means we were able to obtain the carbon dioxide entirely free from air. Before introducing the gas generated in the Kipp apparatus into the compressing cylinder, it was first passed through a bottle containing water, and then bottles containing strong sulphuric acid and pieces of calcium chloride. In the following table one set of observations is given as an example.

*M. Faraday, *loc. cit.*† E. Becquerel, *loc. cit.*‡ G. Quincke, *loc. cit.*§ Bernstein, *Diss. Halle*, 1909.

TABLE V.

Jan. 13, 1917.			CO ₂ (<i>p</i> = 25 atm.).		
VACUUM.			3 ^h 15 ^m P.M., <i>t</i> = 19°·0 C., <i>b</i> = 20·0.		
<i>m</i> _o = 89·3657 gm.			<i>m</i> _{CO₂} + <i>m</i> _o = 89·5867 gm.		
C.	S.	δ.	C.	S.	δ.
amp.	cm.	cm.	amp.	cm.	cm.
0	53·30	-8·50	0	65·60	-15·60
10	44·80	-9·20	10	50·00	-17·00
0	54·00	-7·90	0	67·00	-15·40
10	46·10	-9·70	10	51·60	-16·60
0	55·80	-8·80	0	68·20	-16·40
10	47·00	-8·90	10	51·80	-18·10
0	55·90	-7·90	0	69·90	-13·50
10	48·00	-9·20	10	56·40	-15·50
0	57·20	-8·00	0	71·90	-17·90
10	49·20	-8·40	10	54·00	-18·00
0	57·60	-8·10	0	72·00	-15·90
10	49·50	-9·30	10	56·10	-15·90
0	58·80	-8·90	0	72·00	-16·31 (mean)
10	49·90	-9·70			
0	59·60	-7·70			
10	51·90	-8·68 (mean)			

AIR (<i>p</i> = 1 atm.).			CALCULATION.		
5 ^h 40 ^m P.M., <i>t</i> = 16°·0 C., <i>b</i> = 20·0.			<i>d</i> _{CO₂} = -16·31 + 8·68 = -7·63 cm.,		
<i>m</i> _a + <i>m</i> _o = 89·3706 gm.			<i>d</i> _a = 0·85 + 8·68 = 9·53 cm.,		
C.	S.	δ.	<i>m</i> _{CO₂} = 0·2210 gm., <i>m</i> _a = 0·0049 gm.,		
amp.	cm.	cm.	<i>X</i> _{CO₂} = $\frac{-7·63 \text{ K}}{0·2210} = -34·5 \text{ K},$		
0	53·70	0·80	<i>X</i> _a = $\frac{9·53 \text{ K}}{0·0049} = 1945 \text{ K},$		
10	54·50	0·80	$\frac{X_{CO_2}}{X_a} = \frac{-34·5}{1945} = -0·0177.$		
0	53·70	0·90			
10	54·60	0·90			
0	53·70	0·85 (mean)			

The values of the susceptibility obtained in three sets of observations which were made at a mean temperature 18° C. are

$$10^6 \cdot \chi_{CO_2} = -0·423, -0·429, \text{ and } -0·416.$$

The mean value is

$$\chi_{CO_2} = -0·423 \times 10^{-6}.$$

In the above calculation the susceptibility of air is corrected for the temperature at the time of measurement. As the

diamagnetic susceptibility is considered to be independent of temperature, we can get by multiplying the density of the gas at any temperature and pressure into the specific susceptibility above obtained, the volume susceptibility of the gas at that temperature and pressure; thus we get as the volume susceptibility of carbon dioxide at 20° C. and 760 mm. pressure,

$$\kappa_{\text{CO}_2} = -0.00077_9 \times 10^{-6}.$$

The same consideration is used in the calculation of the susceptibilities of the diamagnetic gases investigated in the present research.

The value of the specific susceptibility of carbon dioxide obtained above is in fair agreement with the value

$$\chi_{\text{CO}_2} = -0.42 \times 10^{-6}$$

for the solid carbon dioxide obtained by Mr. T. Ishiware mentioned above. This shows that the specific susceptibilities of carbon dioxide in the solid and gaseous states are almost equal to each other. Putting for the moment this delicate question of magnitude out of consideration, the close agreement of these determinations seems to give strong confirmation of the conclusion that the value obtained in the present experiment for the gaseous carbon dioxide is not far from the true value. At least we can assert that the magnetism of carbon dioxide is diamagnetic, contrary to all previous determinations. The paramagnetic result of the gaseous carbon dioxide obtained by the previous investigators comes probably from the impurity of the gas examined, such as a trace of air mixed with the gas.

Of the three sets of measurements quoted above, the last one was made by a method which was in some respects different from the other two. The method employed was the null-method described in the last section.

Namely, we measure the force f in terms of the volume of water which is to be supplied or to be taken out of the vessel hanging from the arm of the balance, in order to bring the measuring tube to the initial position against the magnetic force, or which is equivalent, to bring the deflexion of the mirror to its initial reading on the scale. The volume of water can be read from the volume of mercury thread in the capillary tube.

The following table contains the data of the measurement for carbon dioxide by means of the null-method. Here r is the reading of the head of the mercury thread in the capillary

tube, δ is the difference between these readings, and δ_m the mean for each set of observations :—

TABLE VI.

May 28, 1917.				CO ₂ ($p=35$ atm.)			
VACUUM.				$t=18^{\circ}5$ C., $b=10\cdot0$.			
$b=10\cdot0, m_0=98\cdot7750$ gm.				$m_{CO_2}+m_0=99\cdot0673$ gm.			
C.	r .	δ .	δ_m .	C.	r .	δ .	δ_m .
amp.	cm.	cm.	cm.	amp.	cm.	cm.	cm.
0	27·32	-2·48	-2·65	0	29·00	-14·53	-14·73
10	29·80	-2·82		10	43·53	-14·93	
0	26·98			0	28·60		
0	26·76	-2·34	-2·52	0	28·60	-14·55	-14·35
10	29·10	-2·70		10	43·15	-14·15	
0	26·40			0	29·00		
0	26·25	-2·30	-2·55	0	29·35	-14·35	-14·63
10	28·55	-2·80		10	43·70	-14·90	
0	25·75			0	28·80		-14·57(mean)
0	25·70	-2·45	-2·73				
10	28·15	-3·00					
0	25·15		-2·61 (mean)				

AIR.				CALCULATION.			
$t=18^{\circ}0$ C., $b=10\cdot0$,				$d_{CO_2} = -14\cdot57 + 2\cdot61 = -11\cdot96$ cm.,			
$m_a+m = 98\cdot7795$ gm.				$d_a = 7\cdot02 + 2\cdot61 = 9\cdot63$ cm.,			
C.	r .	δ .	δ_m .	$m_{CO_2} = 0\cdot3223$ gm., $m_a = 0\cdot0045$ gm.,			
amp.	cm.	cm.	cm.	$\chi_{CO_2} = \frac{-11\cdot96 \text{ K}}{0\cdot3223} = -37\cdot1 \text{ K},$			
0	24·57	6·87	6·96	$\chi_a = \frac{9\cdot63 \text{ K}}{0\cdot0045} = 2140 \text{ K},$			
10	17·70	7·05		$\chi_{CO_2} = \frac{-37\cdot1}{2140} = -0\cdot0173.$			
0	24·75			χ_a			
0	24·75	7·00	7·08				
10	17·75	7·15					
0	24·90		7·02 (mean)				

The fact that the results of these different methods are in close agreement with each other not only indicates that the deflexion method is practically equivalent to the null-method, but also that the intensity of the magnetic field coming into play is constant, at least in the range in which the measuring tube displaces itself by the magnetization.

The deflexion method is, however, much simpler in operation than the null-method, because the latter method requires much time, and consequently many difficulties are likely to occur during observation, such as those caused by the convection current due to the heating of the electro-magnet. Hence after it was ascertained that the deflexion

method always gives a correct value, it was used throughout the following experiments.

§ 8. NITROGEN.

The literature regarding the magnetic susceptibility of nitrogen is scarcely known. Faraday* first found that the susceptibility of nitrogen is paramagnetic. Becquerel† examined the magnetism of the gas, but he could not detect it. Quincke‡ found a minute paramagnetic effect for gaseous nitrogen. Pascal§ concluded from the study of the susceptibility of some organic compounds containing nitrogen that this element is diamagnetic in its gaseous state. Their values are given in the following table:—

TABLE VII.

Date.	Observer.	$\kappa \cdot 10^6$.
1853	Faraday	+0.0021
1855	Becquerel	0
1888	Quincke	+0.001
1910	Pascal	-0.0005

Thus all the previous investigators except Pascal agree in the view that the susceptibility of gaseous nitrogen is paramagnetic.

In the present experiment special attention was paid to the preparation of nitrogen gas, so as to avoid contamination with air and nitric oxide. Three different methods of preparation were employed, and the susceptibilities of the gases obtained by these methods were compared with each other.

The first two methods consisted of the chemical preparation of pure nitrogen gas, of which the second one was comparatively imperfect and served only as a check on the first, and the last one the preparation of the so-called atmospheric nitrogen, *e. g.* the nitrogen accompanying argon and other inert gases in the atmosphere.

The method of preparation and the experimental data obtained in the magnetic measurement of nitrogen gas thus produced are described below in order.

The first method is the process first used by B. Corenwinder|| in 1849. Though this is an old method, it seems to be an excellent one for the preparation of nitrogen gas of high purity. Lord Rayleigh¶ proved that the nitrogen

* M. Faraday, *loc. cit.*

† E. Becquerel, *loc. cit.*

‡ G. Quincke, *loc. cit.*

§ P. Pascal, *Ann. de chim. et de phys.* viii. p. 1 (1910).

|| B. Corenwinder, *Ann. de chim. et de phys.* (3) xxvi. p. 296 (1849).

¶ Lord Rayleigh, Travers, "Study of Gases," p. 48.

gas thus obtained was free from any trace of the nitric oxide which is more or less present in the nitrogen gas obtained by most of the other methods, and the removal of which was very difficult.

A solution of ammonium chloride and potassium nitrite was gently heated in a flask on a water bath. After all the air in the flask had been expelled, the gas generator was connected with a large glass reservoir and then the gas collected in it. Before introducing the gas into the compressing cylinder, the gas in the reservoir was passed successively through a red-heated copper gauze, bottles containing a solution of ferrous sulphate cooled with ice, strong sulphuric acid, and tubes containing soda lime, calcium chloride, phosphorus pentoxide, and calcium chloride.

The ends of the tubes and of the bottles were brought so closely together that the rubber tubes connecting them were exposed to the gas as little as possible, and all the connecting parts were covered with collodion films.

The following table contains an example of the data obtained in the magnetic measurement:—

TABLE VIII.

Dec. 26, 1916.			VACUUM.		
N ₂ ($p=25$ atm.)			3h 25 ^m P.M., $t=18^{\circ}0$ C., $b=20\cdot0$, $m_{N_2}+m_o=91\cdot31585$ gm.		
C.	S.	δ .	C.	S.	δ .
amp.	cm.	cm.	amp.	cm.	cm.
0	62·80	-5·90	0	49·90	-4·50
10	56·90	-5·90	10	45·40	-3·80
0	62·80	-5·90	0	49·20	-4·45
10	56·90	-5·80	10	44·75	-3·85
0	62·70	-5·88 ₅ (mean)	0	48·60	-4·15 (mean)
AIR ($p=12$ atm.)			CALCULATION.		
4h 33 ^m P.M., $t=19^{\circ}5$ C., $b=20\cdot0$, $m_a+m_o=91\cdot3748$ gm.			$\delta_{N_2} = -5\cdot88 + 4\cdot15 = -1\cdot73$ cm., $\delta_a = 98\cdot00 + 4\cdot15 = 102\cdot15$ cm., $m_{N_2} = 0\cdot09278$ gm., $m_a = 0\cdot0590$ gm., $\chi_{N_2} = \frac{-1\cdot73 \text{ K}}{0\cdot09278} = -18\cdot65 \text{ K}$, $\chi_a = \frac{102\cdot22 \text{ K}}{0\cdot0590} = 1732 \text{ K}$, $\chi_{N_2} = \frac{-18\cdot65}{1732} = -0\cdot0108$.		
C.	S.	δ .			
amp.	cm.	cm.			
0	2·20	98·00			
10	100·20	98·60			
0	1·60	96·90			
10	98·50	98·50			
0	0·00	98·00 (mean)			

Three sets of such measurements gave as the specific susceptibilities of nitrogen gas at a mean temperature 18° C., $10^{\circ} \cdot \chi_{N_2} = -0\cdot258$, $-0\cdot272$, and $-0\cdot265$,

the mean value being

$$\chi_{N_2} = -0.26_5 \times 10^{-6}.$$

The volume susceptibility of nitrogen at 20° and 760 mm. pressure is

$$\kappa_{N_2} = -0.00030_9 \times 10^{-6}.$$

The second method of preparation was due to Mai*. To a mixture of ammonium nitrate and glycerine contained in a flask, a few drops of strong sulphuric acid were added, and the mixture was heated in an oil-bath at about 160° C. The generated gas was collected in a reservoir after passing it through a strong solution of caustic potash. Before the gas was introduced into the compressing cylinder, it was passed through the trains of purifiers, which were the same as those used in the former case, except that in this case the solution of ferrous sulphate was replaced by a strong solution of caustic potash.

One example of the experimental data of the measurement for the nitrogen prepared by the second method is given in the following table:—

TABLE IX.

Jan. 17, 1917.				VACUUM.			
N ₂ (p=25 atm.)				4 ^h 50 ^m P.M., t=19°·5 C., b=20·0.			
4 ^h P.M., t=19°·0 C., b=20·0,				m _o =89·3651 gm.			
m _{N₂} +m _o =89·4828 gm.							
C.	S.	δ.	δ _m .	C.	S.	δ.	δ _m .
amp.	cm.	cm.	cm.	amp.	cm.	cm.	cm.
0	57·70	- 9·35	-10·40	0	59·80	-6·50	-7·00
10	48·35	-11·45	-10·47	10	53·30	-7·50	-7·90
0	59·80	- 9·50	-10·38	0	60·80	-8·30	-8·15
10	50·30	-11·25	-10·28	10	52·50	-8·00	-7·85
0	61·55	- 9·30	-10·32	0	60·50	-7·70	-7·65
10	52·25	-11·35	—————	10	52·80	-7·60	-7·60
0	63·60		-10·37 (mean)	0	60·40	-7·60	—————
				10	52·80		-7·69 (mean)

AIR (p=1 atm.)				CALCULATION.			
6 ^h P.M., t=18°·5 C., b=20·0.				d _{N₂} = -10·37 + 7·69 = -2·68 cm.,			
m _a +m _o =89·3700 gm.				d _a = 1·60 + 7·69 = 9·29 cm.,			
C.	S.	δ.	m.	m _{N₂} = 0·1177 gm., m _a = 0·0049 gm.,			
amp.	cm.	cm.	cm.	χ _{N₂} = $\frac{-2.68 \text{ K}}{0.1177} = -22.76 \text{ K.}$			
0	70·60	0·70	1·45	χ _a = $\frac{9.29 \text{ K}}{0.0049} = 1895 \text{ K.}$			
10	71·20	2·20	1·70	χ _{N₂} = $\frac{22.76}{1895} = -0.0120.$			
0	69·00	1·20	1·55				
10	70·20	1·90	1·70				
0	68·30	1·50	—————				
10	69·80		1·60 (mean)				

* J. Mai, *Ber. d. Deutsch. Chem. Ges.* iii. p. 3805 (1901).

Two sets of such measurements were made for the nitrogen obtained by the second method at a mean temperature 18° C.; the results are

$$10^6 \cdot \chi_{N_2} = -0.288 \text{ and } -0.287,$$

the mean value being

$$\chi_{N_2} = -0.288 \times 10^{-6}.$$

The volume susceptibility at 20° C. and 760 mm. pressure is

$$\kappa_{N_2} = -0.00033_6 \times 10^{-6}.$$

Thus the value of the susceptibility of nitrogen obtained by the second method is about 8 per cent. more diamagnetic than that obtained by the first method, but it was sufficient as a check and no further study was made of the cause of the deviation.

In the third method the atmospheric air was introduced into the reservoir through the bottles, containing a solution of caustic potash, calcium chloride, concentrated ammonia solution, and red-hot copper gauze. Before filling the gas in the compressing cylinder it was passed through bottles containing strong sulphuric acid and calcium chloride, and then through the trains of purifiers, which were exactly the same as those used in the preceding experiment.

The following are the data in the determination of the susceptibility of the atmospheric nitrogen:—

TABLE X.

Jan. 11, 1917.			VACUUM.			
N ₂ (p=30 atm.)			8 ^h 40 ^m P.M., t=14°·7 C., b=20·0,			
6 ^h 10 ^m P.M., t=15°·0 C., b=20·0.			m _o =89·3518 gm.			
m _{N₂} +m _o =89·4916 gm.			m _o =89·3518 gm.			
C.	S.	δ.	C.	S.	δ.	δ _m '
amp.	cm.	cm.	amp.	cm.	cm.	cm.
0	60·00	-11·80	0	56·00	-6·50	-8·00
10	48·20	-11·80	10	49·50	-9·50	-8·35
0	60·00	-12·50	0	59·00	-7·20	-7·70
10	47·50	-11·70	10	51·80	-8·20	-8·10
0	59·20	-11·40	0	60·00	-8·00	-8·35
10	47·80	-10·80	10	52·00	-8·70	-8·60
0	58·60	-12·10	0	60·70	-8·50	-8·75
10	46·50	-11·80	10	52·20	-9·00	-8·55
0	58·30	-11·74 (mean)	0	61·20	-8·10	-7·65
			10	53·10	-7·20	-7·65
			0	60·30	-8·10	-7·95
			10	52·20	-7·80	-----
			0	60·00		-8·15 (mean)

AIR ($p=1$ atm.).			CALCULATION.	
10 ^h 5 ^m P.M., $t=12^{\circ}0$ C., $b=20\cdot0$,			$d_{N_2} = -11\cdot74 + 8\cdot15 = -3\cdot59$ cm.,	
$m_a + m_o = 89\cdot3566$ gm.			$d_a = 0\cdot27 + 8\cdot15 = 8\cdot42$ cm.,	
C.	S.	δ .		
amp.	cm.	cm.	$m_{N_2} = 0\cdot1398$ gm., $m_a = 0\cdot0048$ gm.,	
0	52\cdot70	0\cdot20	$\chi_{N_2} = \frac{-3\cdot59 \text{ K}}{0\cdot1398} = -25\cdot68 \text{ K},$	
10	52\cdot90	0\cdot20		
0	52\cdot70			
0	53\cdot40	0\cdot30	$\chi_a = \frac{3\cdot42 \text{ K}}{0\cdot0048} = 1754 \text{ K}.$	
10	53\cdot70			
0	64\cdot70	0\cdot30		
10	65\cdot00	0\cdot30	$\frac{\chi_{N_2}}{\chi_a} = \frac{-25\cdot68}{1754} = -0\cdot0146.$	
0	64\cdot70	0\cdot30		
10	65\cdot00	0\cdot27 (mean)		

The values obtained in two sets of observations made at a mean temperature 18° C. are

$$10^6 \cdot \chi_{N_2} = -0\cdot363 \text{ and } -0\cdot356,$$

the mean value being

$$\chi_{N_2} = -0\cdot360 \times 10^{-6}.$$

The volume susceptibility at 20° C. and 760 mm. pressure is

$$\chi_{N_2} = -0\cdot00042_2 \times 10^{-6}.$$

Taking the mean of the results obtained for the gas prepared by the first method as the magnetic susceptibility of chemically pure nitrogen gas, we have, as the specific susceptibility of pure nitrogen,

$$\chi_{N_2} = -0\cdot265 \times 10^{-6},$$

and if we consider the result for the last case as the susceptibility of the atmospheric nitrogen containing about 1\cdot7 per cent. of inert gases, of which argon is a chief constituent, we have

$$\chi_{N_2} = -0\cdot360 \times 10^{-6}.$$

The large discrepancy between these results can never be explained as an experimental error; it must be due to the magnetism of the inert gases, and we may assume for the present that the result is due only to the magnetism of argon, as the quantities of other gases are exceedingly small.

Now let us calculate the magnetic susceptibility of air from the susceptibilities of its constituent gases, assuming

that the additive law holds. We have then the following relation:—

$$\chi_a = p_{O_2} \cdot \chi_{O_2} + p_{N_2} \cdot \chi_{N_2} + p_A \cdot \chi_A$$

or

$$\chi_{O_2} = \frac{\chi_a}{p_{O_2}} - \frac{p_{N_2}}{p_{O_2}} \chi_{N_2} - \frac{p_A}{p_{O_2}} \chi_A,$$

where χ_a , χ_{O_2} , χ_{N_2} , and χ_A are the specific susceptibilities of air, oxygen, nitrogen, and argon, and p_{O_2} , p_{N_2} , and p_A are the ratios of the masses of these gases in air to the total mass of air respectively.

Then the value of the susceptibility of argon can be deduced in the following way, taking the percentages of nitrogen and argon in air as follows:—

75.5 and 1.3 per cent.

Hence the percentage of argon in atmospheric nitrogen is

$$\frac{1.3 \times 100}{75.5 + 1.3} = 1.7 \text{ per cent.}$$

But the presence of argon in the atmospheric nitrogen produces an increase of the diamagnetic susceptibility from

$$\chi_{N_2} = -0.265 \times 10^{-6} \text{ to } \chi_{N_2} = -0.360 \times 10^{-6}.$$

Hence the susceptibility of argon will be

$$\begin{aligned} \chi_A &= \frac{-0.360 \times 10^{-6}}{0.017} - \frac{0.983 \times (-0.265) \times 10^{-6}}{0.017}, \\ &= -5.86 \times 10^{-6}. \end{aligned}$$

Taking as the weight percentage of oxygen in air 23.15 and introducing the values for χ_a , χ_{N_2} , and χ_A in the equation for oxygen, we get

$$\begin{aligned} \chi_{O_2} &= \frac{23.85 \times 10^{-6}}{0.2315} - \frac{0.755 \times (-0.265) \times 10^{-6}}{0.2315} \\ &\quad - \frac{0.13 \times (-5.86) \times 10^{-6}}{0.2315} \\ &= (103.0 + 0.9 + 0.3) \times 10^{-6}, \\ &= 104.2 \times 10^{-6}. \end{aligned}$$

But the susceptibility of oxygen directly determined being

$$\chi_{O_2} = 104.1 \times 10^{-6},$$

these two are in fair agreement with each other.

It becomes now clear that the volume susceptibilities of the nitrogen and argon present in the atmosphere are not negligibly small, as was believed to be the case; and that the sum of their values amounts to a little above one per cent. of the susceptibility of air.

§ 9. HYDROGEN.

Hydrogen is one of the gases the magnetic susceptibility of which has been comparatively well studied. Nevertheless, owing to the difficulties which accompany the experiments, we have as yet no reliable experimental value of its magnetic susceptibility; even its sign was not decided till quite recently. But recent investigators seem to agree in the view that hydrogen has a diamagnetic susceptibility, and now the determination of an exact value of its susceptibility becomes an outstanding problem.

Quincke* first determined the magnetic susceptibility of hydrogen, and found as its susceptibility a value

$$\kappa = +0.0003 \times 10^{-6}.$$

Bernstein† published the results of his experiments on the magnetism of some gases in his dissertation at Halle, and gave as the susceptibility of gaseous hydrogen,

$$\kappa = -0.005 \times 10^{-6}.$$

Assuming the additive law, Pascal‡ calculated the atomic susceptibility of hydrogen from the study of some organic compounds; the result of his calculation being

$$\chi = -3.05 \times 10^{-6}.$$

Kammerlingh Onnes and Perrier§ measured the magnetic susceptibility of liquid hydrogen and found as its volume susceptibility,

$$\kappa = -0.186 \times 10^{-6}.$$

Taking for the density of liquid hydrogen a value obtained by Dewar 0.07, he deduced as the specific susceptibility of liquid hydrogen,

$$\chi = -2.7 \times 10^{-6}.$$

No account of the experimental details was given in their

* G. Quincke, *loc. cit.*

† Bernstein, *loc. cit.*

‡ P. Pascal, *loc. cit.*

§ H. Kammerlingh Onnes and A. Perrier, *Amsterdam Proc.* xiv. p. 121 (1911).

paper, but the authors did not claim too much weight for their result and were satisfied with the fact that their result roughly agreed with the value obtained by Pascal.

More recently Biggs* carried out the same investigation of gaseous hydrogen. He tried to overcome the experimental difficulties by utilizing the large absorptive power of palladium for hydrogen, and found too large a value for the susceptibility of the gas.

The chief difficulties met with in the determination of gaseous hydrogen are two: the first is the preparation of pure hydrogen free from oxygen, and the second the determination of the magnetic force exerted upon the gas, owing to the smallness of its volume susceptibility and density. In the present experiment these two difficulties were overcome, and a highly trustworthy value for the susceptibility of hydrogen gas was obtained. The details for the preparation of the pure gas and the determination of its magnetic susceptibility are given in the following pages.

(a) *Preparation of pure Hydrogen Gas.*

In the present investigation the pure hydrogen was prepared by the method which Morley † used in the determination of the volumetric ratio of hydrogen and oxygen in water. The chief differences between his and the present case were in the construction of the decomposing cell and the combustion tube. In my case an open vessel was used as a decomposing vessel, and platinum electrodes were introduced into the cell by insulating the leading wires with glass tubes. Oxygen which was generated at the anode, was allowed to escape into the atmosphere. The electrodes were separated from each other as far as possible in order to lessen the diffusion of oxygen from the anode to the cathode. The open end of the vessel was covered with a mica plate; besides, the upper portion being wholly wrapped in cloth in order to prevent any contamination of liquid.

In the early period of the present experiment, I used for a long time a combustion tube of hard glass, which contained pieces of reduced copper gauze, both ends of the tube being ground and joined to the rest of the purifying train. But in the course of the experiment it was found that in a long period of time the joints became gradually loosened by repeated heating and cooling, allowing the diffusion of air

* H. F. Biggs, *Phil. Mag.* xxxii. p. 131 (1916).

† E. W. Morley, *Amer. Journ. Sci.* iii. xli. p. 220 (1891).

into the tube: hence finally I used palladium asbestos instead of copper; and in this case the heating temperature being below 250°C ., an ordinary glass was used as the combustion tube, both ends of the tube being fused together to the rest of the apparatus. In consequence of this change of arrangement, not only was the measurement of susceptibility of hydrogen greatly facilitated, but the results of the experiment became quite consistent.

The hydrogen generator, purifying train, the reservoir, and the compressing cylinder, together with the measuring tube, are shown in fig. 8. *a* is a large cylinder having a

Fig. 8.

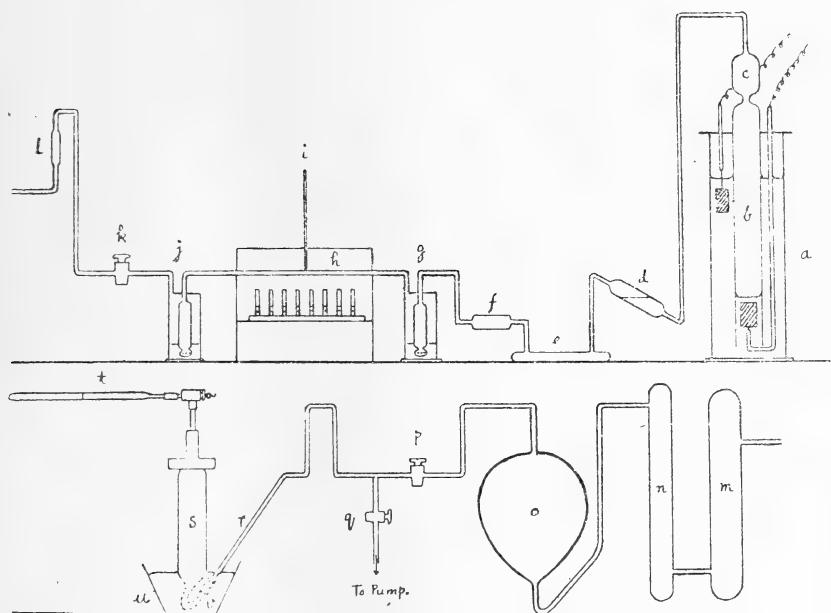

capacity of 4 litres. About 3 litres of pure dilute sulphuric acid was put into it; the concentration of the solution was the same as used by Morley, *e. g.* it contained one-sixth of pure sulphuric acid in volume. *b* is a glass tube placed concentrically with the cylinder in *a*. The anode is placed in the upper portion of the cylinder, while the cathode is placed at the lower part of tube *b*. Each electrode has an area of 25 sq. cm. *c* is a bulb for preventing the passage of the acid fumes upwards. *d* is a large glass bottle filled

halfway with a 50 per cent. solution of caustic potash and placed obliquely. *e* is a long horizontal tube containing fine pieces of glass wetted with the above solution. *f* is a bulb for preventing the mixing of the solution of caustic potash with sulphuric acid in a vessel *g*; *h* is a soft glass tube loosely filled with palladium asbestos, and *i* a thermometer graduated to 360° C. *j* is a wash-bottle containing strong sulphuric acid. *k* is a cock dipped in a mercury bath, which prevents the diffusion of hydrogen to the outside and that of air to the inside. *l* is a tube containing molecular silver, which serves as a sensitive indicator of hydrogen sulphide. *m* is a large cylindrical tube in which rods of caustic potash are placed, and *n* a cylinder containing phosphorus pentoxide. *o* is a large glass bulb having a capacity of about 3 litres. *p* and *q* are two glass cocks, the latter being attached to a side tube leading to a Gaede auxiliary pump. All the stopcocks described above are lubricated with Vakuüm-Hahnfett and dipped in small mercury baths. The end of the delivery tube *r* is brought in contact with the tapered end of the compressing cylinder *s* at *v* and covered with a thick rubber tube, and this connected portion is dipped in a mercury bath *u*. The portion extending from the generator to the end of the delivery tube is wholly made of glass having no ground joint, except the portion of the stop-cocks, and is therefore entirely safe from the leakage of gases for several months.

As the rubber connexion between the compressing cylinder and the delivery tube was used only when the compressing cylinder was to be filled with the gas, the diffusion of air through the rubber tube was negligible; and the gas in the compressing cylinder was proved by an experiment—which will be described later—to be perfectly free from air, so that I could safely use this connexion throughout the whole experiment.

(b) *Filling the Measuring Tube with the Gas.*

The method of filling the compressing cylinder with hydrogen is as follows:—

To drive off the air contained in the purifying train and the reservoir, a current of hydrogen generated in the decomposing cell, at the rate before described, is passed for about two days, while the palladium asbestos is heated to 200° C. After almost all the air has been driven out of the

apparatus with the hydrogen, the stop-cock *k* is closed, and the gas contained in the bulbs *m*, *n*, and *o* pumped out by the Gaede auxiliary pump, and then the cock *q* is closed and *k* opened to introduce the hydrogen into the bulbs *m*, *n*, and *o*. When they are filled with gas the evacuation is again made, and then the new gas introduced. After the same process has been repeated several times the cock *p* is finally closed and the reservoirs are filled with gas till the pressure of the gas reaches about 2 cm. higher than the atmospheric pressure. This pressure is attained when the surface of water in the cylinder *b* of the decomposing cell reaches the lower position, as shown in fig. 8.

To fill the measuring tube and the compressing cylinder with gas, the tapered end of the latter is brought in contact with the end of the delivery tube, and then the air in them is pumped out. When the cock *q* is closed and the cock *p* opened, the gas stored in the reservoir rushes into the evacuated cylinder, filling it almost instantaneously at a pressure of about one atmosphere. Next the cock *k* is opened and new gas supplied to the reservoir, till the former pressure is again attained in about 15 minutes. Thus the cylinder and the measuring tube are always filled with hydrogen at about one atmospheric pressure; they are in an evacuated condition only for a moment, when the communication to the pump is stopped by the cock *q* and the cock *p* opened to introduce the gas into the cylinder. Thus any diffusion of air from outside through the packings and connexions is completely prevented. The same process of washing the interior of the measuring tube and the compressing cylinder with pure hydrogen is usually repeated five times and the gas finally introduced into the tube and the cylinder is employed for the measurement.

The method of measurement of the mass of the hydrogen was to determine the mass by replacing water in a eudiometer with the hydrogen stored up at high pressure in the measuring tube. If the pressure and temperature at the time of measurement of the volume are known, then by taking the vapour pressure at that temperature into consideration, we can calculate the volume of gas at standard conditions. Multiplying the density at 0° C. into the volume obtained above we obtain the mass of the gas. In some cases the determination of the mass of hydrogen was also made by weighing and comparing the weight with the results of the volumetric measurement.

(c) *Results of Magnetic Measurement.*

About thirty independent observations were made for the pure hydrogen gas; the following table contains the data for the magnetic susceptibility of the gas obtained in twelve sets of measurement which give the most reliable results.

In the table, m_{H_2} , t_{H_2} , χ_{H_2} , m_a , t_a , and χ_a denote the masses, temperatures, and specific susceptibilities of hydrogen and air respectively. The experiments are arranged in a chronological order.

TABLE XI.

No.	d_{H_2}	m_{H_2} ^g	T_{H_2}	d_a	m_a	t_a	$-\chi_{H_2}/\chi_a$	$-\chi_{H_2} \cdot 10^6$
1...	-4.63	0.0134	13°·5	13.47	0.00327	13°·0	0.0840	2.052
2...	-2.73	0.0076	15°·0	14.92	0.00332	15°·2	0.0803	1.945
3...	-5.34	0.0127	15°·5	17.22	0.00333	15°·2	0.0815	1.975
4...	-4.44	0.0143	18°·0	18.25	0.00463	17°·2	0.0791	1.903
5...	-5.13	0.0161	18°·0	18.32	0.00464	18°·2	0.0805	1.931
6...	-4.95	0.0156	20°·0	17.34	0.00455	19°·2	0.0834	1.994
7...	-4.99	0.0157	20°·0	17.00	0.00456	20°·0	0.0855	2.039
8...	-4.22	0.0129	22°·0	18.28	0.00450	21°·5	0.0805	1.910
9...	-3.85	0.0124	23°·0	16.51	0.00450	22°·0	0.0846	2.004
10...	-4.85	0.0149	26°·2	16.34	0.00438	27°·0	0.0872	2.030
11...	-4.53	0.0144	22°·5	16.64	0.00454	22°·0	0.0860	2.038
12...	-4.68	0.0156	25°·0	16.19	0.00450	23°·5	0.0834	1.965
							(Mean)	1.982
								±0.015

As we see in the above table, we get as the mean value of the specific susceptibilities of hydrogen obtained from twelve measurements at a mean temperature of about 16° C.,

$$\chi_{H_2} = -1.98_2 \times 10^{-6} \pm 0.01_5 \times 10^{-6},$$

the mean error amounts to 0.76 per cent. of the total value.

Multiplying the density of hydrogen at 20° and 760 mm. pressure, we get as the susceptibility per unit volume of hydrogen at the normal pressure and 20° C.,

$$\kappa_{H_2} = -0.000165_9 \times 10^{-6} \pm 0.000001_3 \times 10^{-6}.$$

The following is an example of the data of the magnetic measurement of gaseous hydrogen:—

TABLE XII.

June 24, 1918.

H_2 ($p=50.0$ atm.).			VACUUM.		
2 ^h 49 ^m P.M., $t=20.0$ C., $b=10.0$.			4 ^h 42 ^m P.M., $b=10.0$.		
C.	S.	δ .	C.	S.	δ .
amp.	cm.	cm.	amp.	cm.	cm.
0	50.50	3.60	0	48.50	9.10
10	54.10	3.10	10	57.60	7.10
0	51.00	3.60	0	50.50	9.00
10	54.60	2.88	10	59.50	7.08
0	51.72	3.58	0	52.42	9.08
10	55.30	2.80	10	61.50	7.15
0	52.50	3.40	0	54.35	8.95
10	55.90	2.72	10	63.30	7.15
0	53.18	3.21 (mean)	0	56.15	8.08 (mean)

H_2 (ditto).			VACUUM.		
3 ^h 5 ^m P.M., $b=10.0$.			5 ^h 3 ^m P.M., $b=10.0$.		
C.	S.	δ .	C.	S.	δ .
amp.	cm.	cm.	amp.	cm.	cm.
0	44.50	3.25	0	46.85	8.35
10	47.75	3.15	10	55.20	7.90
0	44.60	3.12	0	47.30	8.40
10	47.72	2.92	10	55.70	7.60
0	44.80	3.00	0	48.10	8.80
10	47.80	3.00	10	56.90	7.60
0	44.80	3.00	0	49.30	8.90
10	47.80	3.05	10	58.20	7.45
0	44.75	3.45	0	50.75	8.13 (mean)
10	48.20	3.08			
0	45.12	3.10 (mean)			
Total mean		3.16	Total mean		8.11

Volume of gas = 186.1 c.c. at 21.0 C.

Baro. press. = 753.25 mm. at 21.6 C.

AIR ($p=1$ atm.).
 $t=21.5$ C., $b=10.0$,
 Baro. press. = 752.0 mm. at 21.3 C.
 5^h 40^m P.M.

C.	S.	δ .
amp.	cm.	cm.
0	44.95	24.75
10	69.70	25.05
0	44.65	25.45
10	70.10	25.10
0	45.00	26.00
10	71.00	25.00
0	46.00	26.30
10	72.30	25.05
0	47.25	26.75
10	74.00	25.00
0	49.00	25.45 (mean)

CALCULATION.

$$\chi_{H_2} = 3.16 - 8.11 = -4.95 \text{ cm.},$$

$$d_a = 25.45 - 8.11 = 17.34 \text{ cm.},$$

$$m_{H_2} = 0.01556 \text{ gm.},$$

$$m_a = 0.00455 \text{ gm.},$$

$$\chi_{H_2} = \frac{-4.95 \text{ K}}{0.01556} = -318.0 \text{ K.},$$

$$\chi_a = \frac{17.34 \text{ K}}{0.00455} = 3810 \text{ K.},$$

$$\frac{\chi_{H_2}}{\chi_a} = \frac{-3180}{3810} = -0.0834.$$

(d) Purity of the Hydrogen Gas.

Morley* stated that the nitrogen which was present in the hydrogen obtained by his arrangement was less than 1/20000 of the hydrogen, and that the hydrogen is quite free from oxygen. In my apparatus constructed on the same principle as that of Morley, a similar result might have been expected. As the volume susceptibility of the atmospheric nitrogen is twice as large as that of hydrogen, the presence of that amount of nitrogen can produce no sensible change of susceptibility. But the oxygen which might be present in the hydrogen owing to an imperfect purification may be expected to have a serious effect on the value of the susceptibility of the hydrogen. If we take as the volume susceptibilities of oxygen and hydrogen, the values $\kappa_{O_2} = 0.139 \times 10^{-6}$ and $\kappa_{H_2} = -0.000166 \times 10^{-6}$ respectively, we see that the susceptibility of oxygen is 837 times as large as that of hydrogen, and hence a 1/837 volume of oxygen present in hydrogen will cancel the diamagnetism of hydrogen, and a 1/150000 volume of oxygen will diminish its diamagnetism by 0.56 per cent. This is the the same order of magnitude as that of the experimental error in the measurement of the magnetic susceptibility. Hence at least the upper limit of the oxygen content must be known. From the fact that the molecular silver placed in the path of the hydrogen did not show any change in appearance, we know that no sulphur compound was present in the gas.

For this purpose an apparatus as shown in fig. 9 was constructed. *a* is a eudiometer with platinum wires sealed near its closed end for the electric discharge, and *b* a glass tube forming a U-tube, the shorter arm being inserted into the eudiometer with a rubber cock. The longer arm is connected to a glass tube *e* with a rubber tube; the tube *e* is provided with a bulb *f* containing calcium chloride, which is connected to a long rubber tube *g*. The eudiometer is first filled with mercury, and then replacing it with the hydrogen to be examined, the connexion of the eudiometer with the tube *b* is made in a mercury bath. The eudiometer with the tube is then brought in the tank *t* and supported firmly in the vertical position. The tank has a capacity of about 160 litres and is filled with water. The eudiometer and the tube are immersed in the water, leaving only a few centimetres of the upper end of the eudiometer above the surface.

* E. W. Morley, *loc. cit.*

Another eudiometer, which is also filled with hydrogen, is placed side by side; it serves as a control for the change of the atmospheric pressure and the temperature of the tank. The connexion of tubes *b* to tube *e* is then made by a rubber tube *d*. By means of the microscopes *Q*, the head of the meniscus of mercury in *b* is observed; the smallest division of the ocular micrometer corresponds to 1/66 mm.

Fig. 9.

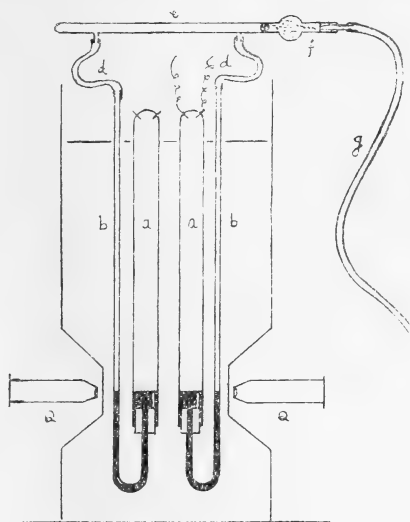

By repeatedly blowing the air at the open end of the rubber tube *g*, we can easily make the height of the meniscus in tubes *b* settle to a correct position. The height of the meniscus is then read with microscopes *Q*. When the temperature of the tubes *b* becomes equal to that of the water in the tank, an electric discharge is passed for 6 minutes through the eudiometer with an induction coil (30 cm. maximum spark distance) working at 12 volts. After an hour, when the temperature of the gas becomes again equal to that of the surroundings, the reading of the meniscus in the tubes is again taken. If the readings of the two microscopes undergo the same amount of change, it is to be concluded that the hydrogen does not contain an amount of oxygen which can be detected with the present apparatus. If, however, some difference in the readings of the microscopes be observed, another electric discharge is passed, and

after an hour the observation is repeated. These processes are repeated so long as there is no relative change in the readings in these microscopes. The length of the eudiometer is about 50 cm. and its inner diameter 17 mm.; while the inner diameter of the tube b is 4 mm.

Let us now consider the change of the height of mercury in the tube b , when a change of volume of the gas in the eudiometer takes place by electric discharge.

Let S and s be the sectional areas of tubes a and b , P and p be the initial and final pressures of the gas in the eudiometer respectively (fig. 10); then if the meniscus of the mercury in tube a is raised by δH , while that in tube b is lowered by δh , we have the following relations:—

$$S \delta H = s \delta h, \quad \text{and} \quad P - p = \delta H + \delta h.$$

Hence we have

$$P - p = \delta h \left(1 + \frac{s}{S} \right),$$

$$\text{or} \quad \frac{P - p}{P} = \frac{\delta h}{P} \left(1 + \frac{s}{S} \right).$$

If the quantity of oxygen previously contained in the hydrogen be very small compared with the total quantity of the gas and the hydrogen was perfectly dry before discharge, the water formed by discharge will remain as vapour, and since one volume of oxygen and two volumes of hydrogen form two volumes of water vapour, the total volume change of the gas due to the discharge is just equal to the volume formerly occupied by the oxygen gas. Hence the term in the left side of the above equation is the ratio of the partial pressure due to the oxygen to the total pressure of the gas. Suppose δh to be 1/66 mm., which is the smallest division of the scale of the microscope, then we have, from the above equation,

$$\frac{P - p}{P} = \frac{1 \cdot 055}{66 \times 760} = \frac{1}{47500} \doteq \frac{1}{50000}.$$

Hence we see that if the height of the mercury meniscus in tube b does not change by more than 1/3 division of the

Fig. 10.

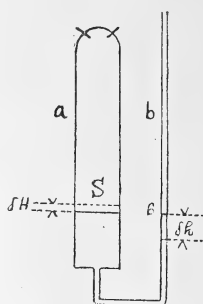

micrometer ocular, the partial pressure due to the oxygen contained in the hydrogen before the discharge is almost less than one-one hundred and fifty thousandth of the total volume. The volume susceptibility of this amount of oxygen is therefore

$$\frac{0.139 \times 10^{-6}}{1.5 \times 10^5} = 0.00925 \times 10^{-10}.$$

This corresponds to about 0.56 per cent. of the susceptibility of the hydrogen gas.

In the actual test for the content of oxygen in the hydrogen gas used in the magnetic measurement, no relative change of the readings of the microscopes exceeding 1/3 division of the ocular was observed. Hence we can safely conclude that the error due to the oxygen, which might be present in the hydrogen gas, is at most less than 0.6 per cent. of the susceptibility of hydrogen (Table XIII. B. & C.). Hence we may take as the correct value of the susceptibility of pure hydrogen gas at the ordinary temperature, the value obtained in the present experiments.

The following tables contain the data of the discharge experiments for the test of the purity of the hydrogen :—

TABLE XIII.

A.

Hydrogen before passing the palladium tube.				Hydrogen after passing the palladium tube heated at about 70° C.			
Time of observation.	Reading of micrometer.		Relative change of reading.	Time of observation.	Reading of micrometer.		Relative change of reading.
	Discharge tube.	Control tube.			Discharge tube.	Control tube.	
1 ^h 5 ^m P.M.	50	50		1 ^h 30 ^m P.M.	50	50	
2 ^h 30 ^m P.M.	8	83		2 ^h 30 ^m P.M.	65	92	
Change of reading.	-42	+33	-75		+15	+42	-27

B.

Hydrogen after passing the palladium tube heated at 150° C.				Hydrogen after passing the palladium tube heated at 200° C.			
Time of observation.	Reading of micrometer.		Relative change of reading.	Time of observation.	Reading of micrometer.		Relative change of reading.
	Discharge tube.	Control tube.			Discharge tube.	Control tube.	
6 ^h 30 ^m P.M.	50	50		0 ^h 45 ^m P.M.	50	50	
7 ^h 30 ^m P.M.	10	10		1 ^h 55 ^m P.M.	27	27	
Change of reading.	-40	-40	0	Change of reading.	-23	-23	0

C.

Hydrogen treated likewise when it is subjected to magnetic measurement.			
Time of observation.	Reading of microscope.		Relative change of reading.
	Discharge tube.	Control tube.	
6 ^h 3 ^m P.M.	90	90	
7 ^h 9 ^m P.M.	90	90	
Change of reading.	0	0	0

The data contained in table B was obtained for the hydrogen directly filling the eudiometer from the delivery tube of the purifying train. The last example was obtained for the hydrogen which was previously compressed in the measuring tube at atmospheric pressures and then delivered into the eudiometer. The sign of the change of reading is positive when the volume of the gas increases, and negative when it decreases; and therefore the negative sign in the last

column indicates that some volume contraction took place in the tube which was caused by the electric discharge. From the above results we see that the hydrogen obtained by the electrolysis of dilute sulphuric acid contains a small quantity of oxygen diffusing from the anode to the cathode; that the hydrogen passed through the palladium tube heated above 150°C . does not contain more than $1/150000$ volume of oxygen, and by table C., that no air was allowed to enter into the hydrogen during the process of compressing the gas into the measuring tube.

§ 10. CONCLUDING REMARKS.

The present experiment is a relative measurement of the susceptibility of gases, in which the susceptibility of pure water is taken as -0.720×10^{-6} . In the measurement of the susceptibility of air, redistilled water was used as the standard substance; for the cases of other gases the air at the ordinary or at some high pressures was used as the substance for comparison.

The specific susceptibility of gases is assumed to be independent of pressure, at least in the range of pressure (1 to 68 atmospheres) in the present experiment. This assumption was found to be correct within the accuracy of the experiment by the fact that the value of the susceptibility of each gas was the same irrespective of the pressure applied,

The values of the magnetic susceptibilities of the gases investigated in the present experiment are summarised below :—

TABLE XIV.

Gas.	$\chi \cdot 10^6$.	$\kappa \cdot 10^6$.
Air.....	+23.8 ₅	+0.0308 ₄
Oxygen	+104 ₁	+0.148 ₈
Carbon dioxide	-0.42 ₃	-0.00083 ₆
Nitrogen (chemically pure)	-0.26 ₅	-0.00033 ₁
Nitrogen (atmospheric)	-0.36 ₀	-0.00045 ₂
Argon	-5.8 ₆	-0.010 ₄
Hydrogen.....	-1.98 ₂	-0.000178 ₁

In the above table the specific susceptibilities are referred to the state at 20°C ., and the volume susceptibilities to that at 0°C . and 760 mm. pressure respectively.

The fact that the susceptibility of air directly determined shows a close coincidence with the value calculated from the susceptibilities of its constituent gases, proves not only the correctness of the values of the susceptibility of each gas, but also that the additive law holds for the susceptibility of a gas mixture. Hence, in deducing the susceptibility of air from that of oxygen, it is not correct to neglect the magnetism of nitrogen and argon. The magnetism of these two gases contributes about one per cent. to the total magnetism of air. It has long been believed by many investigators that nitrogen is paramagnetic, with the exception of Pascal* who obtained a diamagnetic susceptibility for this element by an indirect method. His value corrected for the susceptibility of water is

$$\chi_{N_2} = -0.397 \times 10^{-6}.$$

The value is numerically greater than mine by 50 per cent.

The susceptibility of argon in the present experiment is obtained indirectly and therefore we cannot lay too much weight on the value, and I hope to ascertain it by a direct measurement. But it may be noticed here that by a direct measurement P. Tänzler † found the susceptibility of argon to be

$$\chi_A = -6.1 \times 10^{-6},$$

in close enough agreement.

The gaseous carbon dioxide has hitherto been believed to be paramagnetic; but on the contrary, it is diamagnetic. The specific susceptibilities of solid and gaseous carbon dioxide have almost the same value.

The susceptibility of pure hydrogen gas which does not contain oxygen by more than 1/150000 volume of hydrogen is determined to be

$$\chi_{H_2} = -1.98_2 \times 10^{-6} \pm 0.01_5 \times 10^{-6}.$$

Among the values obtained by previous investigators, those of Pascal ‡ and K. Onnes and A. Perrier § are nearest to the present value. As stated above, the value by K. Onnes and A. Perrier was obtained for the liquid state, and moreover, their determination was not very accurately made;

* P. Pascal, *loc. cit.*

† P. Tänzler, *Ann. d. Phys. Chem.* xxiv. p. 931 (1907). The present value is calculated from the original value by taking $\chi_{O_2} = 104.1 \times 10^{-6}$.

‡ P. Pascal, *loc. cit.*

§ K. Onnes & A. Perrier, *loc. cit.*

and hence we cannot attach too much weight to their value. Since Pascal's value was obtained by calculation from the measurement of the susceptibility of organic compounds, we cannot expect that his value will coincide with that of the susceptibility of the gaseous hydrogen directly determined.

Lastly, we shall consider the above results by experiments in the light of the electron theory. According to Langevin's theory, Bohr's model for hydrogen molecules gives a strong paramagnetism by magnetization, as shown by J. Kunz*, while the observed polarization is diamagnetic. If, however, we suppose the Bohr molecules to be revolving about an axis through the middle point of the line joining two positive nuclei and perpendicular to it, then, as shown by Professors K. Honda and J. Okubo†, the magnetization produces a diamagnetic effect. That is, the velocity of this rotation, though there is no thermal agitation, is supposed to have a definite value characteristic of hydrogen molecules, which is, however, far smaller than the high velocity of revolving electrons; then the radius and the velocity of electrons in Bohr's model are very little affected by the characteristic rotation of the positive nuclei. Hence denoting by K the moment of inertia of the molecule about the axis of characteristic rotation, and Ω_0 its angular velocity, then the energy of rotation will be, n being Loschmidt's number,

$$\frac{n}{2} K \Omega_0^2.$$

The diamagnetic susceptibility per one gram molecule is then

$$\chi = \frac{1}{8} \frac{\sigma_0^2}{n} - \frac{\sigma_0^2}{4nK\Omega_0^2},$$

where σ_0 is the magnetic moment of saturation per gram molecule, that is,

$$\sigma_0 = ne\omega r^2,$$

where e is the charge of an electron, ω the angular velocity, and r the radius of the electron orbit. Thus the susceptibility of hydrogen gas is diamagnetic, as actually observed,

* J. Kunz, Phys. Rev. xii, p. 59 (1918).

† K. Honda and J. Okubo, *loc. cit.*

and independent of temperature. In Bohr's model *, we have

$$r = 0.525 \times 10^{-8} \text{ cm.}, \quad \omega = 4.21 \times 10^{16} / \text{sec.},$$

and therefore

$$\sigma_0 = 1.117 \times 10^4, \text{ E.M.U.}$$

Hence, at a given temperature, the value of susceptibility depends on $\frac{n}{2} K \Omega_0^2$. In order that the above expression may give the observed value, we must take

$$\frac{n}{2} K \Omega_0^2 = 393.5 \times 10^{10} \text{ ergs},$$

or $\Omega_0 = 6.54 \times 10^{14} / \text{sec.}$

This angular velocity corresponds to the frequency

$$\nu = 1.04 \times 10^{14} / \text{sec.}$$

of the infra-red radiation. A similar expression holds also for the susceptibility of other diatomic gases.

According to Bohr, the helium atom has two positive nuclei at the centre of the circular orbit, in which two electrons are revolving with a constant velocity. If we assume that the helium atom has a similar structure to the hydrogen molecule, in which two positive nuclei are situated very near to each other, the atom may possess a similar characteristic rotation as in the case of the hydrogen molecule. We have then

$$\chi = - \frac{\sigma_0^2}{4nK\Omega_0^2}.$$

According to Bohr,

$$r = 0.318 \times 10^{-8} \text{ cm.}, \quad \omega = 19 \times 10^{15} / \text{sec.}$$

Therefore

$$\sigma_0 = 1.81 \times 10^3 \text{ E.M.U.}$$

In order therefore that the above expression may give a value of susceptibility $\chi = -11.0 \times 10^{-6}$, as actually observed by Tänzler †, we must take

$$\frac{n}{2} K \Omega_0^2 = 7.84 \times 10^{10} \text{ ergs},$$

or $\Omega_0 = 3.80 \times 10^{15} / \text{sec.}$

* N. Bohr, *loc. cit.*: P. Debye, *loc. cit.*

† P. Tänzler, *loc. cit.* The present value is calculated from the original value by taking $\chi_{O_2} = 104.1 \times 10^{-6}$.

But since Ω_0 is here not very small as compared with ω , we cannot use Bohr's values for ω and r , and consequently Ω_0 will acquire a somewhat different value from that above given.

Thus Bohr's models for hydrogen and helium atoms give by magnetization a diamagnetic polarization, whose values are of a right order of magnitude, provided that there is a definite rotation about an axis perpendicular to the line joining two positive nuclei, the velocity of which is very small compared with the velocity of revolving electrons.

According to the above results, monatomic and diatomic gases are all diamagnetic, and their susceptibilities can be calculated, provided the models of the molecules are known; this conclusion generally agrees with the observed facts.

One important exception is the case of oxygen, which is a diatomic gas. But if we assume that in virtue of the form and nature of oxygen molecules, the characteristic rotation is completely absent and the rotational energy of revolving electrons is relatively small, then in place of the expression for susceptibility above given, we have *

$$\chi = \frac{\sigma_0^2}{3 \left(\frac{n}{2} \sum K \omega_0^2 + RT \right)},$$

where ω_0 is the angular velocity of revolving electrons, K the moment of inertia of the electron about its axis, and RT the rotational kinetic energy corresponding to Langevin's paramagnetism. Hence χ is positive and varies hyperbolically with temperature. Thus by assuming particular conditions, the paramagnetism of oxygen gas may be explained.

In the case of polyatomic gases, the resultant magnetic axis of the molecules is not generally perpendicular to the axis of the characteristic rotation, as in the case of the diatomic gases. In this case, if we resolve the magnetic moment into two components parallel and perpendicular to the axis of the characteristic rotation, the former produces a paramagnetic effect and the latter a diamagnetic; the observed polarization is the sum of these two effects, which may be positive or negative. Thus the polyatomic gases are paramagnetic or diamagnetic according to their natures.

In the above discussion the molecules are assumed to be rigid and no account is taken of the Langevin diamagnetism. If the small term of this diamagnetism be introduced, the above conclusions do not materially change.

* K. Honda and J. Ôkubo, *loc. cit.*

Thus the magnetization of different gases can be satisfactorily explained by the theory of Professors K. Honda and J. Ōkubo by introducing certain assumptions, not only qualitatively but also quantitatively.

In conclusion I wish to express my deepest obligation to Professor K. Honda, under whose suggestion and constant guidance the present investigation was carried out. I also wish to express my hearty thanks to Professors M. Ogawa and M. Katayama, of the Department of Chemistry, for their valuable suggestions and criticisms in the work. My thanks are also due to Messrs. N. Yamada and K. Shikata who kindly helped me in the preparation of pure gases in the early part of the present research.

Physical Institute
of the University, Sendai.
April 26, 1919.

XXX. *An Experimental Determination of the Inertia of a Sphere moving in a Fluid.* By GILBERT COOK, M.Sc., A.M.Inst.C.E.*

IT has been shown by Stokes † that when a solid body is in motion in a frictionless fluid of infinite extent, the effect of the fluid pressure is equivalent to an increase in the inertia of the body. The effect is manifest only in cases of accelerated or retarded motion, and has a direct application to the dynamical theory of the oscillating mine, which the writer had occasion to study during the war.

The only cases for which the magnitude of the increase of inertia has been determined analytically are those of the cylinder of infinite length moving at right angles to its axis, and of the ellipsoid of revolution, including the sphere. The case of the sphere, in which the increase of inertia is found to be one-half of the mass of fluid displaced, is one which lends itself readily to experimental verification.

The experiment was carried out in a tank 15 feet in diameter and 30 feet in depth. The spherical body consisted of a mine-case 38·2 ins. in diameter ballasted in such a manner that its weight in water was approximately one pound, the displacement being 1080 lb. It was allowed to fall freely through the water under the influence of gravity. The motion was recorded by means of an instrument designed

* Communicated by Prof. J. E. Petavel, F.R.S.

† Trans. Camb. Phil. Soc. vol. viii. (1843); 'Collected Papers,' vol. i. p. 17.

by the writer for the study of oscillatory motions under water, a light cord attached to the mine-case passing round the drum of the instrument, and equal intervals of time being indicated by a small lateral movement given to the recording pen electrically from a clock. From the record thus obtained the velocity and acceleration at any instant could be measured. The friction of the instrument was negligible, but a counterpoise applied for the purpose of maintaining a small tension in the cord reduced the downward force on the mine-case by 0.06 lb.

The equation of motion may be written :—

$$M' \frac{dv}{dt} = F - kv^n,$$

where M' is the inertia of the body, v the velocity, F the vertical force due to gravity (corrected for counterpoise of the recording instrument), and kv^n a term expressing the frictional resistance to the motion of the body through the fluid.

The correct value of n will be such as to make the relation between $\frac{dv}{dt}$ and v^n linear. As the frictional resistance is mainly that due to skin friction and eddy formation, it might be anticipated that n would have a value approximating to 2.

The values of the velocity, acceleration, and square of velocity are given in the following table :—

Time (secs.).	v . (ft. secs.).	$\frac{dv}{dt}$ (ft. secs. ²).	v^2 .
2.5	0.1333	0.01814	0.0178
5	0.1768	0.01667	0.0312
7.5	0.2195	0.01745	0.0482
10	0.2631	0.01747	0.0691
12.5	0.3026	0.01412	0.0916
15	0.3383	0.01440	0.1145
17.5	0.3711	0.01187	0.1378
20	0.3988	0.01024	0.1592
22.5	0.4233	0.00936	0.1792
25	0.4458	0.00867	0.1990
27.5	0.4683	0.00932	0.2193
30	0.4895	0.00760	0.2395
32.5	0.5075	0.00680	0.2575
35	0.5238	0.00627	0.2748

The relation between $\frac{dv}{dt}$ and v^2 is plotted in fig. 1. It will be seen that the plotted points lie close to the straight line

$$y = 0.0193 - 0.0494 x.$$

352 *Determination of Inertia of a Sphere moving in a Fluid.*

The vertical force due to gravity was 0.950 lb., so that by comparison with the equation

$$M' \frac{dv}{dt} = F - kv^2$$

the value of M' will be seen to be 158± lb., or 1.46 times the displacement of the body.

Fig. 1.

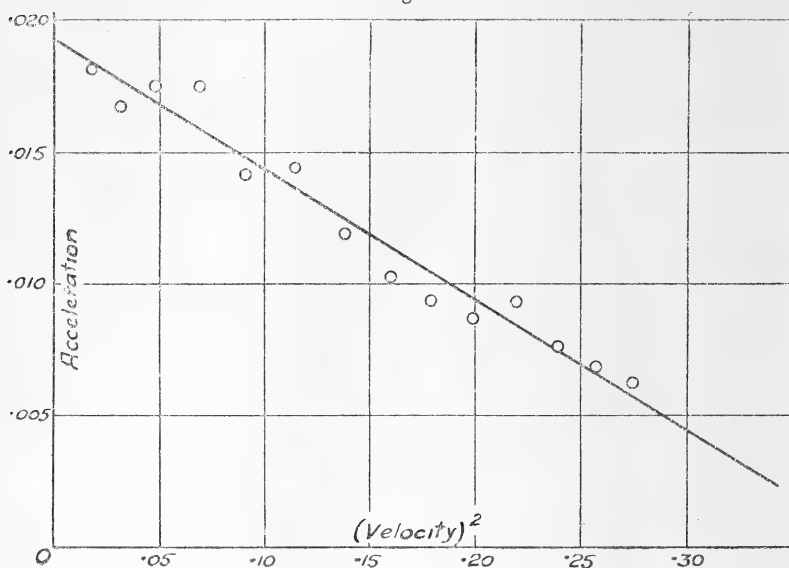

The value of k , the coefficient of resistance, expressed in gravitational units, is 2.44 for this particular case. Assuming the resistance R to be proportional to the square of the diameter, so that

$$R = k'd^2v^2,$$

the value of k' is 0.241, the units being feet, pounds, and seconds.

Having in view the modification of the theoretical flow which may be caused by frictional resistances, the value obtained for the increase of inertia, namely 0.46 times the displacement, may be considered a sufficient verification of the value deduced analytically for this case. It may be pointed out that any error involved in the assumption of the value 2 for the index of n , whilst modifying the frictional coefficient, would affect the value of the inertia obtained from the experiment by a negligible amount. Although the fluid was not of unlimited extent, the ratio of the dimensions of the tank to those of the sphere were sufficiently large to render the effect of the cylindrical walls inappreciable.

XXXI. *A New Cadmium Vapour Arc Lamp.*

By FREDERICK BATES*.

THE necessity for increasing the intensity as well as the number of monochromatic light sources has frequently been emphasized during the past few years. Unfortunately but little has been accomplished toward attaining this objective. In 1906, the writer† directed attention to the importance of this subject and suggested that the so-called yellow-green line ($\lambda = 5461 \text{ \AA}$) of incandescent mercury vapour be adopted as the source for standardization purposes in polarimetric work. The quartz-mercury vapour-lamp was a great advance in that it provided not only the yellow-green line, but several additional lines of lesser intensity. The best available methods of optical purification are such that a monochromatic source is of little value unless the line is sufficiently removed from its immediate neighbours that nearly complete separation by spectrum filtration is possible. If sufficient light to satisfy modern practical and research needs is to be obtained from any such source it is necessary to use a relatively wide slit, with a consequent probable inclusion of other wave-lengths in the immediate vicinity of the one desired.

When the most intense of all known light sources, namely, the direct radiation of the sun, is utilized, the necessary slit width, while less than that for any other known source, must still be such as to include a relatively large number of wave-lengths. The resultant wave-length or so-called optical centre of gravity of such a group of waves can be considered as a monochromatic light source in only a very restricted sense, and finds effective application in but few fields of work. It is especially unsuited to the study of phenomena which change rapidly with change of wave-length. The necessity for obtaining additional intense light sources is consequently imperative.

Among the possible sources which have been suggested is that of the rotating arc with cadmium-silver alloy electrodes. This source gives a number of fairly intense lines sufficiently isolated from each other and fairly well distributed throughout the spectrum. The writer has carried out many experiments with this source, using an improved rotating arc. It

* Communicated by the Author.

† Bulletin of the Bureau of Standards, vol. ii. p. 239.

was found impossible to maintain an arc sufficiently free from flicker to give satisfactory results.

Another possible source experimented with is the quartz cadmium vapour arc lamp, described by Lowry and Abram*. This lamp is always unsatisfactory owing to two defects. It is necessary to have it permanently connected to an air-pump and to immerse the electrodes in water. If the cadmium in a vapour lamp is sufficiently pure, the adhesion between the cadmium and the quartz results in the destruction of the lamp upon the solidification of the cadmium. An improved form of lamp has been brought out by Sand†. In this type, the tendency of the cadmium to adhere to the quartz walls is stated to be lessened by introducing into the lamp a small amount of zirconia in the form of fine powder. The cadmium is placed in a side tube connected to the pump and the body of the lamp by a tube constricted to three capillaries for the purpose of filtering the metal. Additional filtering may be obtained by introducing a roll of iron gauze. Extensive experiments by the writer with this type of lamp have demonstrated that it is impracticable, provided a pure cadmium spectrum is desired. The method of filtering suggested is inadequate. The impurities introduced into the lamp by this method of filling undoubtedly have a tendency to prevent breakage, but effectively prevent obtaining a relatively pure, intense cadmium spectrum. In order to eliminate all oxide and other impurities from the cadmium used in filling, it is necessary to carefully distil the cadmium into the body of the lamp. Upon allowing the lamp to cool, adhesion between the quartz and the metal takes place in spite of the presence of the zirconia. If the lamp does not crack upon the first solidification of the cadmium, thin sections of the quartz are peeled from the walls by the contracting metal. Upon cooling a second time, the lamp was invariably cracked.

Numerous experiments of varied character failed to overcome the constant breakage of the Sand lamp. Among the filling mixtures tried was a cadmium-mercury alloy. The percentages of the constituents were varied on a wide range. The introduction of the mercury is very effective in preventing the cracking of the lamp, as the alloy formed was so soft that no appreciable adhesion between it and the quartz resulted. It was found, however, impossible to obtain a brilliant cadmium spectrum under any circumstances.

* Trans. Faraday Soc. vol. x. p. 103 (1914).

† Proc. Phys. Soc. London, vol. xxviii. p. 94 (1915-16).

The vapour-pressure of the mercury being so much higher than that of the cadmium, resulted in the electric energy being almost entirely carried by the mercury, and the usual brilliant mercury spectrum resulted.

In view of the preceding facts, it is evident that a serviceable brilliant cadmium-vapour lamp might be obtained by alloying the cadmium with a suitable element of lower vapour-pressure. Through the courtesy of Dr. W. F. Hillebrand, a quantity of the little-known element, gallium, was obtained. The material was in a very impure condition, containing approximately 10 per cent. indium. The freezing-point was below 22° C., at which temperature it was a liquid with a viscosity less than that of mercury. A study of the impure material was made by Dr. G. E. F. Lundell, who succeeded in obtaining the gallium in a relatively pure condition.

Crude gallium was dissolved in aqua regia, treated with sulphuric acid and fumed to remove nitric acid. After dilution, small amounts of lead sulphate were filtered off. The solution was then diluted, treated with hydrogen sulphide and filtered to remove the hydrogen sulphide group of elements. The filtrate was boiled to expel hydrogen sulphide and treated with ammonium hydroxide. The precipitate was filtered off, dissolved, and reprecipitated three times to free it from zinc. The final separation from indium was based on the solubility of gallium hydroxide in a solution of sodium hydroxide and the insolubility of indium hydroxide in that reagent. The sodium hydroxide separation was carried through three times. The deposition of gallium was finally carried out by electrolysis of the alkaline solution as recommended by Uhler and Browning*.

The purified gallium had a freezing-point of approximately 30° C. This surprising fact has since been verified by the careful work of Richards†, who has definitely fixed this temperature at 30°·8 C. Regarding the boiling-point of this element, but little is known. The few experiments which have been made are in agreement that it is above 1500 degrees C. This property should make it an ideal substance for the purpose in hand, provided it would alloy with cadmium. The first experiment demonstrated that it united with the cadmium with the utmost ease. In fact, the addition of a few drops to ten or fifteen cubic centimetres of cadmium completely changed the texture of the latter,

* *Am. Jour. Sci.* excii. (xlii. Fourth Series) p. 389 (1916).

† *Jour. Am. Chem. Soc.* vol. xli. p. 131.

rendering it relatively soft and greatly reducing its tensile strength. Subsequently it was discovered that upon distilling the cadmium from the alloy at a pressure of 0.001 mm. of mercury, the minute quantity of gallium carried through was sufficient to completely change the character of the cadmium and to prevent adhesion between the cadmium and the walls of the lamp.

Fig. 1

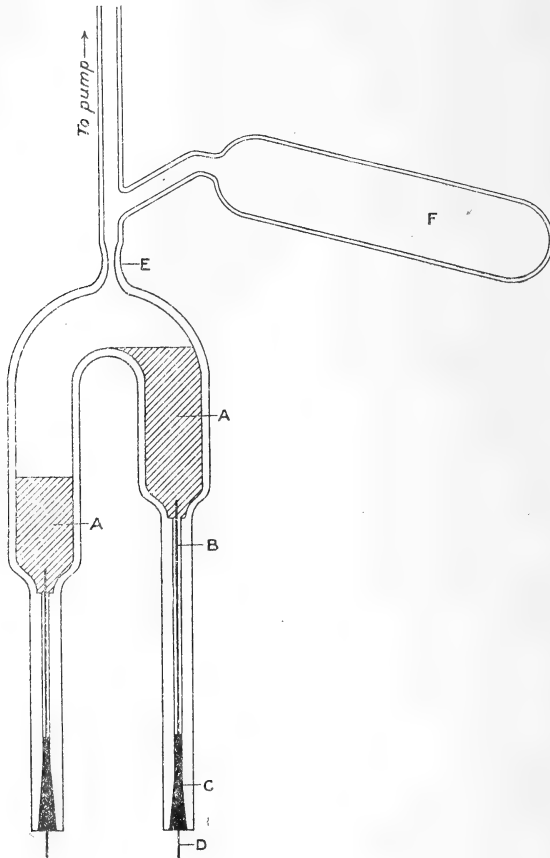

The type of quartz lamp used in the experiments is that shown in figure 1. The total volume is approximately ten cubic centimetres. The electrodes consist of tungsten wires (B) entering through quartz capillaries. They are closed with lead seals similar to the type described by Sand*.

* Proc. Phys. Soc. London, vol. xxvi. p. 127 (1914).

Fig. 2.

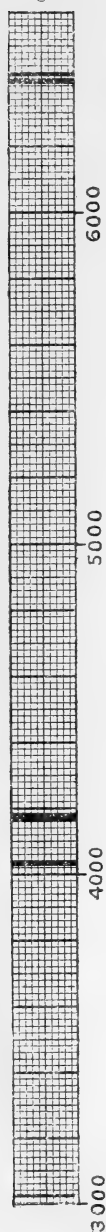

In filling the lamp, the cadmium containing two or three per cent. gallium is placed in the bulb F. It is necessary to maintain the pressure in the lamp and connexions below 0.001 mm. of mercury with the exception of that due to the cadmium and gallium, throughout the process of distilling. Owing to the fact that the volume of the lamp is relatively small, the quartz capillary at E should be of such a length as to permit of sealing off in the shortest possible time. The flame used for this purpose should be small, and the heating of the tube on both sides of the capillary should be prevented as far as possible.

The method indicated above, if carefully followed, will give a lamp with indefinite life. One of this type has been in intermittent use for over a year and shows no sign of deterioration. Should traces of oxide or stains due thereto appear during the process of filling, they can readily be reduced by introducing pure dry hydrogen and heating. The lamp may be started by heating with a flame to vaporize the metal. It is in all cases advisable to have a current of air blowing upon the lead seals to keep them cool. If the blast is allowed to strike the body of the lamp, the cadmium is condensed and obscures the arc. The most convenient source of energy for operation is the ordinary 110 volt lighting circuit, on which it will operate continuously with a current as small as 3 amp. and a drop of 14 volts across the terminals of the lamp. The most satisfactory results, however, are secured with a current of about 7 amp. and a drop across the terminals of about 25 volts. Under this condition a practically pure cadmium spectrum of great brilliancy is obtained. The intensity secured is apparently equal to that which would be obtained were the lamp filled with cadmium alone. The map* of the spectrum of gallium given in figure 2 is interesting. The wave-lengths and intensities of the lines are given in Table I. in this connexion. It will be observed that there are but five lines in the visible spectrum and that from practically 4200 A. to 6400 A. there are no lines.

* Eder & Valenta, *Atlas Typischen Spektren*.

TABLE I.

Visible Spectrum of Gallium.

Wave-length A.	Intensity.
3020·61	3
4033·18	10
4172·22	20
6396·99	8
6413·92	6

When the lamp is operated at a temperature sufficiently high to bring the quartz to a cherry-red colour, and there is danger of softening the lamp, several gallium lines become faintly visible. The investigations of Uhler and Browning* indicate the possibility of two gallium lines 5353·81 A and 5359·8 A. However, these lines, if present, are so faint at the highest temperature at which the lamp can be operated, that they cannot be identified. The cadmium spectrum is thus obtained in a condition exceedingly favourable for those purposes for which an intense monochromatic light source is indispensable. No gallium lines are found between 4200 A and 6400 A, and the gallium lines which are detectable have so low an intensity that they are wholly negligible in polarimetric and other fields of work.

There are now available practically no dependable intense monochromatic red light sources. Any source to meet modern demands must permit of continuous operation with minimum amount of attention and an absence of flicker. The very pure red line ($\lambda = 6439$ A) of cadmium seems to be the only possible source of sufficient intensity in this region of the spectrum. It is believed that the cadmium-gallium lamp will make this much needed source, as well as other lines of the cadmium spectrum, available for many lines of endeavour.

The writer desires to acknowledge his indebtedness to Mr. F. P. Phelps for valuable assistance in the experimental work.

Bureau of Standards,
Washington, D.C.

* Amer. Jour. Sci. xlii. p. 389 (1916).

XXXII. *On Radiation from a Cylindrical Wall.*By S. P. OWEN, *B.Sc. Wales* *.

IN the experiments conducted by Todd (Proc. Roy. Soc. A. vol. lxxxiii. (1909)) on the thermal conductivity of gases, the problem of the effect of the radiation from the cylindrical vertical wall on to the horizontal lower disk arose. The effect was not calculated but was eliminated by experimental means (*l. c.* p. 20).

In the following paper an expression is deduced for the amount of heat radiated from a cylindrical vertical wall similar to the insulating ring in Todd's experiments, to a horizontal circular plate placed near the bottom.

The conditions are slightly different from those obtaining in Todd's experiments, in that here the temperature of the wall is assumed constant whereas in the insulating ring there is a linear gradient of temperature from the top to the bottom. Very little alteration is needed in the calculation to fit these latter conditions.

The result is tested by obtaining values of the Radiation Constant by a simple experiment which makes no claim to great accuracy. The values obtained agree closely with the accepted value. The experiment is described in the second part of the paper.

§ 1. *Theoretical.*

Let a = radius of cylinder,

b = AO = radius of the copper plate.

Consider two elements of surface, one at G and the other on the plate at F .

Let θ be the angle between two vertical planes, one containing GN the diameter of the cylinder through G and the other GH , a line in the same horizontal plane as GN , the plane cutting the plane of the plate in the line DF .

Since the plate is symmetrically placed with respect to the cylinder, evidently $\hat{E}DC = \theta$.

GF is the line joining the two elements at G and F making angle ϕ with GH .

Taking D as the origin let $DF = r$ and $DG = x$.

* Communicated by Prof. G. W. Todd, D.Sc.

If N = normal radiation from the element at G , the total radiation received from G at F

$$= \frac{N \cos \theta \cos \phi \sin \phi \cdot r \cdot dr d\theta dx dc}{d^2},$$

where $r \cdot dr d\theta$ = area of the element at F ,
 $dx dc$ = area of the element at G ; dc being an element of the circumference of the cylinder,
 and d = FG .

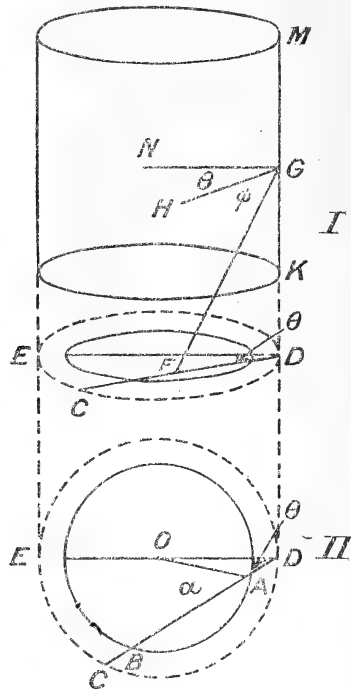

This will be absorbed by the disk if the latter be a perfect absorber of radiation.

The total radiation received by the whole plate from the whole cylinder

$$= 2 \int_0^{2\pi a} \int_{x_1}^{x_2} \int_0^{\sin^{-1} \frac{b}{a}} \int_{DA}^{DB} \frac{N \cos \theta \cos \phi \cdot \sin \phi \cdot r dr d\theta \cdot dx \cdot dc}{d^2}, \dots (1)$$

where $x_1 = DK$ and $x_2 = DM$.

In II., taking $\widehat{O\hat{A}B} = \alpha$,

$$DA = a \cos \theta - b \cos \alpha,$$

$$DB = a \cos \theta + b \cos \alpha,$$

and $b \sin \alpha = a \sin \theta.$

$$\therefore DA = a \cos \theta - \sqrt{b^2 - a^2 \sin^2 \theta}$$

and $DB = a \cos \theta + \sqrt{b^2 - a^2 \sin^2 \theta}.$

In I., $\cos \phi = \frac{r}{d} = \frac{r}{\sqrt{a^2 + r^2}}, \quad \sin \phi = \frac{a}{\sqrt{a^2 + r^2}}.$

Hence (1) becomes

$$2 \int_0^{2\pi a} \int_{x_1}^{x_2} \int_0^{\sin^{-1} \frac{b}{a}} \int_{DA}^{DB} \frac{N \cos \theta \cdot x r^2 dr \cdot d\theta \cdot dx \cdot dc}{(x^2 + r^2)^2}.$$

Integrating with respect to c and then to r we get

$$4\pi a N \int_{x_1}^{x_2} x dx \int_0^{\sin^{-1} \frac{b}{a}} \frac{\cos \theta}{2x} \left[\tan^{-1} \frac{DB}{x} - \tan^{-1} \frac{DA}{x} - \frac{1}{2} \sin 2 \tan^{-1} \frac{DB}{x} + \frac{1}{2} \sin 2 \left(\tan^{-1} \frac{DA}{x} \right) \right] d\theta.$$

Using the above values for DA and DB we get after reduction

$$\tan^{-1} \frac{DB}{x} - \tan^{-1} \frac{DA}{x} = \tan^{-1} \frac{2x \sqrt{b^2 - a^2 \sin^2 \theta}}{x^2 + a^2 - b^2};$$

therefore as part of the integral with respect to θ we get

$$\begin{aligned} & \int_0^{\sin^{-1} \frac{b}{a}} \cos \theta \tan^{-1} \frac{2x \sqrt{b^2 - a^2 \sin^2 \theta}}{x^2 + a^2 - b^2} d\theta \\ &= \int_0^{\sin^{-1} \frac{b}{a}} \frac{A a^2 \sin^2 \theta \cos \theta}{\sqrt{b^2 - a^2 \sin^2 \theta} \{1 + A^2 (b^2 - a^2 \sin^2 \theta)\}} d\theta \end{aligned}$$

where $A = \frac{2x}{x^2 + a^2 - b^2}$ by integration by parts,

Putting $a \sin \theta = b \sin \phi$, this reduces to

$$\begin{aligned} & \int_0^{\frac{\pi}{2}} \frac{\Lambda b^2 \sin^2 \phi}{a} \cdot \frac{b \cos \phi \cdot d\phi}{b \cos \phi (1 + \Lambda^2 b^2 \cos^2 \phi)} \\ &= \frac{\Lambda b^2}{a} \int_0^{\frac{\pi}{2}} \frac{\sin^2 \phi}{1 + \Lambda^2 b^2 \cos^2 \phi} d\phi \\ &= \frac{\pi}{2a\Lambda} \{ \sqrt{1 + \Lambda^2 b^2} - 1 \} \\ &= \frac{\pi}{4ax} \{ \sqrt{(x^2 + a^2 - b^2)^2 + 4b^2 x^2} - (x^2 + a^2 - b^2) \}. \end{aligned} \quad (2)$$

Taking the part $\int_0^{\sin^{-1} \frac{b}{a}} \cos \theta \cdot \sin 2 \cdot \tan^{-1} \frac{DB}{x} d\theta$,

$$i. e. \int_0^{\sin^{-1} \frac{b}{a}} \cos \theta \sin 2 \cdot \tan^{-1} \left(\frac{a \cos \theta + \sqrt{b^2 - a^2 \sin^2 \theta}}{x} \right) \cdot d\theta,$$

and putting $a \cos \theta + \sqrt{b^2 - a^2 \sin^2 \theta} = y$,

the integral reduces to

$$\int_{\sqrt{a^2 - b^2}}^{a+b} \frac{y^2 + a^2 - b^2}{\sqrt{4a^2 y^2 - (y^2 + a^2 - b^2)^2}} \left(y - \frac{y^2 + a^2 - b^2}{2y} \right) \frac{2x}{a(x^2 + y^2)} \cdot dy.$$

$$\text{Similarly} \int_0^{\sin^{-1} \frac{b}{a}} \cos \theta \sin 2 \cdot \tan^{-1} \frac{DA}{x} \cdot d\theta$$

$$= \int_{\sqrt{a^2 - b^2}}^{a-b} \frac{y^2 + a^2 - b^2}{\sqrt{4a^2 y^2 - (y^2 + a^2 - b^2)^2}} \left(y - \frac{y^2 + a^2 - b^2}{2y} \right) \frac{2x}{a(x^2 + y^2)} \cdot dy.$$

$$\therefore \int_0^{\sin^{-1} \frac{b}{a}} \frac{1}{2} \left(\sin 2 \cdot \tan^{-1} \frac{DA}{x} - \sin 2 \cdot \tan^{-1} \frac{DB}{x} \right) \cos \theta \cdot d\theta$$

$$= \frac{1}{2} \int_{a+b}^{a-b} \frac{2xy(y^2 + a^2 - b^2)}{a(x^2 + y^2) \sqrt{4a^2 y^2 - (y^2 + a^2 - b^2)^2}} dy$$

$$- \frac{1}{2} \int_{a+b}^{a-b} \frac{x(y^2 + a^2 - b^2)^2}{ay(x^2 + y^2) \sqrt{4a^2 y^2 - (y^2 + a^2 - b^2)^2}} \cdot dy.$$

In the first part put $y^2 - a^2 - b^2 = 2ab \sin \theta$, and we get

$$\frac{1}{2} \int_{\frac{\pi}{2}}^{-\frac{\pi}{2}} \frac{2x}{a} \cdot \frac{a^2 + ab \sin \theta}{x^2 + a^2 + b^2 + 2ab \sin \theta} d\theta,$$

which gives after integration

$$-\frac{\pi x}{a} \left\{ \frac{a^2 - x^2 - b^2}{\sqrt{(x^2 + a^2 + b^2)^2 - 4a^2b^2}} + 1 \right\} \dots \quad (3)$$

Using the same substitution in the 2nd part, *i. e.*

$$-\frac{1}{2} \int_{a+b}^{a-b} \frac{x(y^2 + a^2 - b^2)^2}{ay(x^2 + y^2)\sqrt{4a^2y^2 - (y^2 - a^2 + b^2)^2}} dy,$$

we get

$$\begin{aligned} & \frac{x}{2a} \int_{-\frac{\pi}{2}}^{\frac{\pi}{2}} \frac{4a^4 + 8a^3b \sin \theta + 4a^2b^2 \sin^2 \theta}{(a^2 + b^2 + 2ab \sin \theta)(x^2 + a^2 + b^2 + 2ab \sin \theta)} d\theta \\ &= \frac{x}{2a} \int_{-\frac{\pi}{2}}^{\frac{\pi}{2}} \left\{ 1 + \frac{B}{a^2 + b^2 + 2ab \sin \theta} + \frac{C}{x^2 + a^2 + b^2 + 2ab \sin \theta} \right\} d\theta, \end{aligned}$$

$$\text{where } B = \frac{(a^2 - b^2)^2}{x^2} \quad \text{and} \quad C = -\frac{(a^2 - b^2 - a^2)^2}{x^2},$$

which gives after integration

$$\frac{\pi x}{2a} \left[1 + \frac{B}{a^2 - b^2} + \frac{C}{\sqrt{(x^2 + a^2 + b^2)^2 - 4a^2b^2}} \right].$$

The whole integral (1)

$$\begin{aligned} &= \frac{4\pi aN}{2} \int_{x_1}^{x_2} \left[\frac{\pi}{4ax} \left\{ \sqrt{(x^2 + a^2 - b^2)^2 + 4b^2x^2} - (x^2 + a^2 - b^2) \right\} \right. \\ &\quad \left. - \frac{\pi x}{a} \left\{ \frac{a^2 - b^2 - x^2}{\sqrt{x^2 + a^2 + b^2 - 4a^2b^2}} + 1 \right\} \right. \\ &\quad \left. + \frac{\pi x}{2a} \left\{ 1 + \frac{B}{a^2 - b^2} + \frac{C}{\sqrt{(x^2 + a^2 + b^2)^2 - 4a^2b^2}} \right\} \right] dx. \end{aligned}$$

$$\text{Now } \sqrt{(x^2 + a^2 - b^2)^2 + 4b^2x^2} = \sqrt{(x^2 + a^2 + b^2)^2 - 4a^2b^2}.$$

Using this and substituting the values for B and C the integral reduces to

$$\pi^2 N \int_{x_1}^{x_2} \left\{ \frac{x(x^2 + a^2 + b^2)}{\sqrt{(x^2 + a^2 + b^2)^2 - 4a^2b^2}} - x \right\} dx.$$

Putting $x^2 + a^2 + b^2 = y$,

$$\begin{aligned} \text{the first part} &= \frac{1}{2} \int \frac{y}{\sqrt{y^2 - 4a^2b^2}} dy \\ &= \frac{1}{2} [\sqrt{y^2 - 4a^2b^2}]. \end{aligned}$$

$$\begin{aligned} \therefore \text{Total Integral} &= \frac{N\pi^2}{2} [\sqrt{(x_1^2 + a^2 + b^2)^2 - 4a^2b^2} \\ &\quad - \sqrt{(x_2^2 + a^2 + b^2)^2 - 4a^2b^2} - x_1^2 + x_2^2]. \end{aligned}$$

When the wall and disk are "full" radiators then

$$N = \frac{R}{\pi} = \frac{\sigma}{\pi} \cdot (T_1^4 - T_2^4),$$

where R is the total radiation, σ the Radiation Constant, T_1 and T_2 the absolute temperatures of the cylinder and disk respectively.

\therefore Amount of heat received by the disk

$$\begin{aligned} &= \frac{\pi\sigma}{2} (T_1^4 - T_2^4) [\sqrt{(x_1^2 + a^2 + b^2)^2 - 4a^2b^2} \\ &\quad - \sqrt{(x_2^2 + a^2 + b^2)^2 - 4a^2b^2} - x_1^2 + x_2^2]. \quad (5) \end{aligned}$$

§ 2. Experimental Verification.

Using the above result, the radiation constant σ was determined by the following experiment:

The apparatus consisted of an ordinary steam jacket, the inside of which was covered by an even layer of lampblack obtained by the burning of camphor. This was fixed in a vertical position.

The amount of heat radiated to a copper plate was measured by means of a modification of Bunsen's Ice Calorimeter. The plate consisted of the bottom of a copper calorimeter, enclosed in a block of wax, the bottom being exposed, sheer with the surface of the wax. A capillary tube, previously calibrated, was fitted through a rubber stopper to the top of the calorimeter. The inside of the vessel was filled with crushed ice and water, and by fitting in the stopper the capillary tube could easily be filled with the water from the vessel. By observing the rate at which the meniscus in the capillary moved, the amount of contraction and hence the amount of heat given up to the ice in unit time could be calculated.

In order to eliminate the heat radiated from the surroundings, a guard-ring filled with crushed ice was used. This was made so that the plate could be completely cut off from exposure to the cylinder, and by means of an aperture equal in size to that of the plate, it could be exposed to the cylinder at will.

Observations were taken at half-minute intervals, a few minutes with the plate covered, then exposed, and finally with the plate covered again. The mean of the first and last set of values was subtracted from the mean of the second set and thus the heat radiated from the cylinder was obtained.

In the experiments, which were conducted with two cylinders of different heights, the diameter of the plate was practically equal to that of the cylinder, thus putting in the expression (5) $a=b$, it simplifies to :

$$H = \sigma(T_1^4 - T_2^4) \frac{\pi}{2} \left\{ x \sqrt{x^2 + 4a^2 - x^2} \right\}_{x_1}^{x_2}$$

This expression was used in the calculation :

- Average radius of plate and cylinder = 2.35 cm.
- Volume of capillary per cm. length = .0201 c.c.
- Mean contraction per minute when plate was covered = c_1 cm.
- Mean contraction per minute when plate was exposed = c_2 cm.

T_1 .	T_2 .	x_1 .	x_2 .	c_1 .	c_2 .	$c_1 - c_2$.	$\sigma \times 10^5$.
373° abs.	273° abs.	1.1 cm.	23.3 cm.	2.3 cm.	2.88 cm.	.58 cm.	4.88
		1.5 „	21.8 „	1.26 „	1.76 „	.5 „	4.88
		2.1 „	24.3 „	.73 „	1.12 „	.39 „	4.94

The accepted value of $\sigma = 5.32 \times 10^{-5}$ ergs/cm.² sec. deg.⁴

In conclusion, I must express my great indebtedness to Dr. G. W. Todd, who suggested the problem and whose advice and criticism has been invaluable in the experimental work.

Royal Grammar School,
Newcastle-on-Tyne,
Sept. 1919.

XXXIII. *On the Measurement of Time—a Rejoinder to Dr. N. Campbell.* By L. SILBERSTEIN, Ph.D., Lecturer in Math. Physics at the University of Rome*.

THE paper on "A Time-Scale, etc." by the present writer, published in the September issue of this Magazine, opens the investigation by a statement that the principle of common time-scales amounts to this:—A certain kind of motion (translatory or rotatory) is declared to be a *uniform* motion; the path is then cut up by means of compasses etc. into a series of *equal segments* (or angles) and the instants of passage of the mobile through the divisions of this metrical scale are taken as $t=0, 1, 2, 3,$ and so on.

Dr. N. Campbell, in the November issue of the Phil. Mag. (pp. 652-4), believes "this statement to be untrue." It will be my duty to show that it is true. In the second place, Dr. Campbell believes "still more untrue" (as if truth were liable of gradations) "the statement implied, that time-measurement is impossible except by some such artificial and elaborate method as he [Silberstein] proposes." Now, concerning this second point, I have not said nor meant to imply that *other* methods independent of space-measurement were impossible. I simply proposed one, without excluding the possibility of other methods being invented by others. Thus I have nothing more to say about this second point. A third point, however, is that Dr. Campbell offers us his own views on the measurement of time, and these are so palpably unsatisfactory as to require but a few words to be refuted.

But let me first attend to the first point. Now, my statement, quoted at the outset, is not only logically true (that is to say, that a theory of chronometry based on "uniform" motion and paths or angles carved up into "equal" parts would be a possible logical theory), but also, which is of great importance, *historically true*, the two principles, uniformity and rigid subdivision or transfer, being the dominant and basal features of every practical chronometry since times immemorial and up to, and including, our own days. In fact, the most ancient measurement of time, as practised by Babylonians, Assyrians, Egyptians, and whom not, was based on the assumption of uniformity of rotation of the heavenly sphere round the Earth, and on a rigid, metrical subdivision of the angles involved in this phenomenon. Massive columns were erected and carefully kept

* Communicated by the Author.

for this purpose; later on, up to our days, sun-dials were constructed, and improved with the aid of Euclidean geometry. And the *first step* (not the last, as Dr. Campbell thinks) was here emphatically the picking out of some grandiose phenomenon and declaring it to go on or to evolve "uniformly," "equably." Nor did these principles of chronometry suffer any serious shock from the great Copernican reform. Somehow our forefathers chose to declare the Earth's revolution round the Sun and its spinning motion about its own axis as "uniform," and continued to subdivide the associated angles. Manifestly the sun-dials, or their prototypes, continued to show the hours in spite of the modified standpoint. Yet these natural solar clocks had their bad side, which perhaps is best expressed by the old and beautiful words to be still read on some sun-dials in Italy:

Horas non numero nisi serenas.

Other time-keepers were, therefore, invented and constructed in very early times, that is to say, even much before Copernicus, whom we mentioned only incidentally—and in all of them the said two features played a dominant rôle. I do not propose to enumerate here all such old chronometrical devices; nor have I the required historical erudition. But one such device attributed to Alfred the Great, who ruled over the West Saxons (871–901), I cannot pass here in silence, since it seems particularly characteristic in relation to our subject. According to what my little boy heard in his school*, Alfred the Great had good tall candles (of what stuff I know not) made for him, and, confiding no doubt in the uniformity of their burning down, divided them into equal segments, and thus knew the time in day or night. But apart from the "nisi serenas" condition, the solar clocks had the defect of not being applicable to short time spans (certainly not to our "seconds," and not even to our "minutes"), and the other famous kind of natural time-keepers, the human heart or "pulse," was too often affected by passion or disease to retain permanently the title of uniform (here uniform *succession* of discrete pulse-beats). Thus the mediæval physicist and astronomer had recourse to a variety of artificial chronometric devices. Even a long time before the Renaissance complicated wheel machines were constructed as clocks, but none of them was "well regulated" until the times of Galileo and, more especially,

* I have no other means at the moment to verify the historical truth of this report.

Huyghens. Properly speaking, these “chefs-d’œuvre d’agencement cinématique de mouvements,” as Jules Andrade calls them, were not “regulated” at all, *i. e.* were felt not to be worth the name of “uniformly going,” not keeping pace with the heavenly clock. The now undisputed merit of constructing the first clock in the modern sense of the word is due to Huyghens, although it was Galileo’s discovery of the “isochronism” of small pendulum oscillations which he utilised in such an ingenious way. Yet, before Huyghens’s invention, Galileo, who was the first to measure comparatively short time-intervals, constructed his own clock for the sake of his famous investigations on falling bodies, a water-clock that is, but more precise than the water- or sand-clocks and the “mechanical” clocks which he inherited from his predecessors. Galileo’s own clock is, in the present connexion, as instructive as the burning candle of Alfred the Great. It consisted of a vessel or water-basin of *large section* having a *very small* hole in its bottom, to ensure, no doubt, the “uniformity” of the outflow of that liquid. This was his first care. The remainder of the procedure was again in full harmony with our statement; Galileo measured the volume of the water (by weighing it, that is, but this only to make the volume measurements more precise), and he spoke of $t=1, 2, 3$, etc., as proportional to the number of equal volumes of water; this is equivalent to measuring lengths along the axis of a well-calibrated and narrow cylindrical vessel, if he had one. Galileo’s times (the t in his great law $s \sim t^2$) were proportional to these volumes or ultimately lengths, read on a metrical scale. That the same principles can be instantly traced in all our modern clocks, watches, and chronometers, needs scarcely to be insisted upon.

But they occur perhaps in their purest form in those modern instruments which serve to measure very short times, even down to one-millionth of a second, and perhaps a little less. I have in mind Siemens’s high-speed spark chronograph. It consists, in essence, of a little revolving drum of good steel driven by a carefully finished clock-work. Against this drum, which we used (1897) to cover tightly with a strip of paper blackened with a turpentine lamp soot, is mounted an isolated platinum electrode. Sparks correlated with the events in question pass between the platinum point and the spinning drum and leave marks (little craters) on its blackened surface. The clockwork is then stopped and the drum turned round slowly by a micrometric screw, while the marks are viewed through an appropriately placed microscope. Their angular distance, as read on a subdivided

circle of the hand-screw, gives the time-interval between spark and spark. This is the "space-measurement"; and the "uniformity" was most emphatically expressed in a letter of Siemens and Halske accompanying the apparatus, to this effect: If you wish to obtain satisfactory results, do not start the sparks at once but only after the drum was already spinning for a good while, a prescription, no doubt, based upon the makers' dynamical knowledge of the driving machinery, but at any rate a direct appeal to what had to be *trusted* to be uniform beforehand, without in this case the least possibility of checking the uniformity by investigating, as Dr. Campbell says in his concluding paragraph, whether the "body covered equal distances in equal times," the "equality" of these minute intervals being in this case not otherwise actually definable, unless one appealed to yet another *uniformity*, viz. that of the propagation of electromagnetic waves along the wire-systems*. I have dwelt upon this example, not only because it shows the two principles in their neatest form, but also because in writing my first paper on the time-scale, I had this spark-chronograph incessantly in my mind. The same remarks can literally be repeated with regard to all the familiar devices in which the drum is replaced by a light rotating mirror used as reflector. Very minute time-intervals are thus being measured and give well consistent results.

But intervals still much shorter, the periods of light-oscillations, are measured again on the same principles. The propagation of light is declared to be uniform, and then linear segments (translated more or less indirectly on a magnified scale into an interference pattern) associated with this propagation are measured in the Euclidean fashion. And there is even an ever-growing *à priori* confidence into the uniformity of light-propagation and a tendency to make it the highest court of appeal for all properly mechanical uniformities.

In short, every precise chronometry is kinematical (motion of bodies or propagation of light), and the foremost concept of kinematics is that of "uniform motion," exactly so as is that of "straight line" in geometry. Both are, theoretically, undefined terms, and in application things are declared to be good approximate samples of either or pointed out (with the finger, as it were)—this or that is uniform, this or that

* The interval between the sparks was, in the application of the chronograph I have in mind, due to the difference of the two corresponding circuits, one very short and the other about 3 km. long.

is straight. There is no defining of "straight" nor of "uniform." All so-called definitions of these terms are but apparent, each of them containing a vicious circle.

A definition of uniform motion such as Dr. Campbell repeats after the naïve little text-books [to wit: "we define uniform motion as that of a body which covers equal distances in equal times," p. 654] would be exactly as bad as: a straight line is that which slopes down or up (relatively to another straight!) by equal heights in equal horizontal distances. It is precisely such a "definition" which prevents most people from seeing the possibility of non-intersecting, Lobatchevskyan straights and the hypothetical nature of Euclid's parallel axiom. And the kinematical correlata of these things are made manifest in my first paper, showing the possibility of a generalized (hyperbolic) system of kinematics. The analogy between "uniform" and "straight" becomes still more manifest if one thinks of the modern relativist's four-world, in which a "straight" stands for a space-straight as well as for uniform motion or propagation. But there is no need to appeal to that famous "union" of space and time to show the fundamental, irreducible character of uniform motion; this character belongs to it historically, since times immemorial until our days. Both the assumption of uniformity and the rigid subdivision of the paths or angles are inherent in all the more precise chronometric methods ever devised by man.

This settles the first and chief point of the present note. It is scarcely necessary to add that in declaring such and such a phenomenon to go on uniformly the physicist's, or the astronomer's, choice is, among other things, based upon reasons of convenience, aiming at a certain kind of simplicity of laws or differential equations, such as I attempted to explain in the introductory chapter of the "Theory of Relativity."

The second point being already settled at the very beginning, let us pass at once to our third point, concerning that is Dr. Campbell's own views on the question of the measurement of time. Dr. Campbell is under the fatal misapprehension that he requires but "three definitions" in order to set up a system of measurement of time [nay, of any other magnitude]. These are his (1), (2), and (3), p. 653. The second concerns only the equality of two time-intervals whose both the beginning and the ends coincide, and the third fixes only, in the usual way, the meaning of the sum of two adjacent (consecutive and gapless) intervals. They need not detain us any further. The whole burden is loaded

upon (1) which reads: "The period occupied by the happening of some definite process in a definite system is defined to be 1." Now, if this "definite process" stood for a *single* particular process covering a single interval of time, obviously nothing could be done with (1), (2), (3). It would amount to as much as giving on a straight a pair of points, O, A, calling *OA* the "segment 1," and declaring any segment *LN* to be the sum of the (adjacent) segments *LM* and *MN*. This would never enable us to say what is a segment 2, or 3, and so on.

But, if I well grasp his meaning, Dr. Campbell understands by "definite process," a process such as a fall or a complete oscillation, happening now, or five minutes hence or to-morrow, and so on. This, however, amounts not to solving the problem of measurement, but to massacring it at its very root, or else it amounts to a concealed assumption of uniformity of (in this case) the succession of a discrete set of events. To make my meaning clear, let that standard process be a complete oscillation of a pendulum (to-and-fro) marked by an audible click at its beginning and at its end. Then Dr. Campbell defines *all* the intervals between a click and the next click as equal to one another, zeroth to first = first to second = fifth to sixth, and so on. But this means either the setting up of an indefinite series of entirely arbitrary time-scale divisions, or else contains the tacit belief in the uniformity of the succession of the clicks. Such a procedure *per se* would not deserve the name of chronometry; it would be chronoscopy pure and simple. I say, *per se*, *i. e.* without relating the pendulum-oscillations to some fundamental kinematical and dynamical principles. With such support the scale would cease to be merely chronoscopic; but then it would indirectly rest upon some continuous uniform motion as the fundamental concept of the very science (mechanics) which is its support. If so, however, then it is preferable to utilize directly a uniform motion (instead of a uniform succession of discrete clicks), say, a uniform spinning—which brings us back to both of our old principles. In fact, Huyghens, who certainly preceded everybody in applying the pendulum to chronometry, used it only as an auxiliary, intervening in his mechanism at discrete instants, and he utilized for rigid subdivision the continuous spinning motion of his wheels. (Such also is the only rôle of the pendulum in our modern clocks.) That our last remarks are by no means superfluous can be seen from Dr. Campbell's embarrassment when, having dealt very rapidly with "integral numerals," he looks for fractional

intervals. "The fractions"—he says—"can be obtained by *other pendulums*," with my italics. Thus, other and other pendulums are to be declared as fresh standards (for instance, for $t = \frac{1}{3}$ we should require a smaller pendulum, such that its three oscillations just fill out the interval between two clicks, for $t = \frac{1}{7}$, yet another, and for what Siemens's chronograph yields, a pendulum of ultra-molecular dimensions); thus the postulate (1) would have to be extended and enriched without any end. (Moreover, the 'fractional' pendula could only be found by endless trials, for Dr. Campbell's set (1), (2), (3) does not yield a method of constructing the required subdivisions. Nor is, of course, such a scheme adaptable to any somewhat refined chronometry.) Is this satisfactory? Is such a set as Dr. Campbell's (1), (2), (3) satisfactory as the basis, logical or physical, of a theory of time-measurement? I think not.

Moreover, Dr. Campbell believes (1), (2), (3) to be good enough for a theory of the measurement, not only of time, but also of any other "magnitude." He quotes time only as a little example. Now, temperature is certainly an example of "magnitude," and better still, length or distance is another, and it would be extremely interesting to see Dr. Campbell setting up an intrinsic scale in both of these cases, most especially in the latter one.

The psychological clue to all fallacies of Dr. Campbell is contained in his concluding sentence: "Of course, this is all as elementary as A B C." If this were so, gigantic mentalities, such as was Cayley and many of his successors here and abroad, would never have devoted so much time to what is known as the Theory of Distance.

November 4, 1919.

XXXIV. *An attempt to determine if Common Lead could be separated into Isotopes by Centrifuging in the Liquid State.*
By J. J. JOLY, F.R.S., and J. H. J. POOLE, B.A.I.*

SINCE it has been discovered that both the Uranium and Thorium radioactive families yield elements which are isotopic with ordinary lead but differ from it slightly in atomic weight and density, it has often been suggested that common lead itself is not a homogeneous element, but consists of a mixture of isotopic uranium and thorium lead. This view of the constitution of common lead is based on the fact that

* Communicated by the Authors.

both its atomic weight and density are found to be intermediate between those of its two isotopes, and that therefore an appropriate mixture of the two isotopes would have the same mean atomic weight and density as ordinary lead. If this idea of the real nature of lead were correct, it would seem to be possible that some separation of its two constituents, which would differ by about 1 per cent. in density, might be effected by centrifuging the lead while in the liquid state. Such a separation could be most easily detected by determinations of the density of the lead from the top and bottom of the centrifuging tube, and this was the method adopted in these experiments.

The centrifuge used was one constructed by Leune of Paris, which runs at about 9000 revolutions per minute. The lead was contained in steel tubes, which were fitted with steel lids to avoid oxidation of the lead as far as possible. Quartz containing tubes were first tried, but were found too weak to stand the strain of centrifuging. The steel tube containing the lead was heated by means of a coil of asbestos-insulated nichrome wire wound round it. This coil was kept in place by two collars turned on the steel tube, one at each end, so that in effect it was really bobbin-shaped externally. The whole tube with its heating coil fitted into the usual outer metallic holder of the centrifuge, which hung from trunnions in the ordinary way.

The heating current was supplied to the coil in the following manner:—One end of the heating coil was connected to the outer metallic holder of the centrifuge which made contact with the main rotating spindle of the centrifuge through the supporting trunnions of the tube. As it was not desirable to pass a current through the bearings of the centrifuge, a copper gauze brush was used to make contact with the vertical spindle of the centrifuge, and this brush was connected to one pole of the source of current. The other end of the heating coil was connected by a flexible connexion to an insulated horizontal copper disk which was fixed on the top of the vertical spindle of the centrifuge. A vertical carbon rod was used to make contact with this disk. This rod was insulated from the main body of the centrifuge and held in contact with the revolving copper disk by a simple adjustable spring device. It was connected to the other pole of the source of current, and thus the circuit through the heating coil was completed. As the carbon was arranged to be concentric with the axis of rotation of the centrifuge, the minimum amount of power was wasted by the brush.

The method of procedure in conducting an experiment was as follows:—The steel tube was first carefully cleaned and then filled to the requisite height with lead which was melted in a small porcelain crucible. The lead used was pure lead obtained from Johnson, Matthey & Co. The small lid was placed on the steel tube, and the three other carriers of the centrifuge carefully balanced against the one containing the steel tube and lead. The carriers were then replaced in the centrifuge and the lead melted by turning on the heating current for about ten minutes, after which time the motor driving the centrifuge was started, and usually the centrifuge was kept running for about an hour before being stopped. It was found impossible to run the centrifuge for longer as the motor was inclined to overheat after this period. When the centrifuge was stopped the lead was removed, while still liquid, in six lots by means of glass pipette arrangement. The density of the top and bottom portions of the lead was then determined.

The density of the lead was determined by casting small spherical bullets from it in an iron bullet-mould. These bullets were weighed first in air and then suspended in methylene iodide. Methylene iodide is especially suitable for this purpose, both on account of its high specific gravity (about 3.3) and also its small surface-tension. Fortunately it only attacked the lead very slightly, producing a very slight tarnish on the surface. Some trouble was experienced at first in obtaining sound castings from the lead, but it was found that by allowing the mould to cool slowly from the bottom upwards, bullets free from all cavities could be obtained. It is essential that the conditions under which the bullets are cast should be as nearly identical as possible, as unfortunately the density of lead is largely affected by the heat treatment it receives. However, the results show that this source of error was eliminated. The balance used was sensitive to $\frac{1}{10}$ mgrm., and the weights were standardized against a new set by Becker & Co. which had a certificate from the N.P.L. certifying them as correct to $\frac{1}{10}$ mgrm.

Summary of Results.

NOTE:—W = weight of bullet in air,

B = loss of weight in methylene iodide.

Hence $\frac{W}{B}$ is proportional to density.

Experiment.	W ÷ B.		Remarks.
	Bottom Bullet.	Top Bullet.	
XV.	3·4015	3·4033	Top Bullet 0·05 per cent. denser.
XVI.	3·4092	3·4094	Top Bullet 0·006 per cent. denser.
XVII.	3·4112	3·4111	Top Bullet 0·003 per cent. lighter.
XXII.	3·4090	3·4090	No difference.
XXIII.	3·4065	3·4069	Top Bullet 0·01 per cent. denser.

It will be seen from these results that there is absolutely no evidence for any separation effect. The density of the upper and lower bullets agree as well as could be expected, as a difference of $\frac{1}{10}$ mgrm. in B which weighed about 3 grms. would cause an error of 0·003 per cent. in the density. The slight variation of the density from day to day is probably due to the variation in the temperature of the methylene iodide, and may also be caused by small variations in the casting conditions. This point was not fully investigated as the method is essentially a comparison one.

It is rather difficult to form an idea of the separation we might hope to obtain on theoretical grounds, owing to our ignorance of the equation of state for a liquid. Since these experiments were inaugurated, however, Drs. Lindemann and Aston have shown, in a paper entitled "The Possibility of Separating Isotopes," that if we neglect compression, and assume equal atomic volumes for both leads, and then treat one lead as simply dissolved in the other, we might expect to get a concentration of thorium lead at the edge nearly 50 per cent. greater than that at the centre, if the peripheral velocity was about 10^5 cm. per sec. In our case, however, a peripheral velocity of only about 10^4 cm. per sec. could be attained, which would only lead to a difference in concentration of about $\frac{1}{2}$ per cent. This would only give a difference of 0·005 per cent. in density, which is too small to be detected by the method of determining the density used. On these grounds, then, it is not surprising that with the centrifuge at our disposal no positive results were obtained. It would seem, however, certainly possible that with a specially constructed centrifuge some definite result might be obtained.

Iveagh Laboratory,
Trinity College, Dublin.

XXXV. *On the Effect of Centrifuging certain Alloys while in the Liquid State.* By J. JOLY, F.R.S., and J. H. J. POOLE, B.A.I.*

DURING the course of the experiments described in the previous paper as to the effect of centrifuging liquid lead, certain alloys were also dealt with. The results obtained are appended.

It will be seen that in the case of the silver-lead alloys no definite separation could be obtained. The silver-lead alloys were specially dealt with, as, if silver and lead could be separated by centrifuging, the process might perhaps be cheaper and more expeditious than the existing cupellation method. Unfortunately the method appears to be a failure, at least with the velocities we were able to employ.

In the case of all the other alloys an undoubted separation was effected. In all cases, there is a considerable difference in density between the constituents of the alloy, and no very large amount of separation was effected. It is of interest that a definite alloy like lead-tin alloy, which is of the composition PbSn, should be capable apparently of being separated by the action of the centrifuge.

Silver-Lead Alloys.

Exp.	Composition.	W B		Result.
		Bottom.	Top.	
XIII.	Pb 97 per cent. Ag 3 " "	3·3761	3·3746	Positive. Top bullet about 0·045 per cent. lighter.
XVIII. ...	Pb 95 per cent. Ag 5 " "	3·3937	3·3947	Negative. Top bullet about 0·03 per cent. denser.
XXI.	Pb 90 per cent. Ag 10 " "	3·3892	3·3833	Positive. Top bullet about 0·17 per cent. lighter.
XXIV. ...	Pb 90 per cent. Ag 10 " "	3·3922	3·3923	Negative. Top bullet about 0·003 per cent. denser.

Other Alloys.

XIV.	Pb 63·6 per cent. Sn 36·4 " "	2·8308	2·8129	Positive. Top bullet about 0·63 per cent. lighter.
XXVI. ...	Ditto.	2·8530	2·8114	Positive. Top bullet about 1·5 per cent. lighter.
XX.	Pb 82 per cent. Sn 18 " "	3·0594	3·0328	Positive. Top bullet about 0·9 per cent. lighter.
XXV.	Ditto.	3·1078	3·0519	Positive. Top bullet about 1·8 per cent. lighter.
XIX.	Pb 32 per cent. Sn 16 " " Bi 52 " "	2·9979	2·9679	Positive. Top bullet about 1 per cent. lighter.

Iveagh Laboratory,
Trinity College, Dublin.

* Communicated by the Authors.

XXXVI. *Notices respecting New Books.*

Problems of Cosmogony and Stellar Dynamics. By J. H. JEANS, M.A., F.R.S. Being an essay to which the Adams Prize of the University of Cambridge for the year 1917 was adjudged. Cambridge: at the University Press, 1919. 293 pp., 5 plates.

THE essay is a daring attempt, in continuation of previous attacks initiated by Maclaurin, Kant and Laplace, and followed up by Roche, Jacobi, Kelvin, Poincaré, and G. H. Darwin, to continue the investigation of possible configurations of a rotating gravitating fluid mass, and of its stability, and to carry it on to a gaseous conglomeration, as of the spiral and other nebulae.

The book falls then into two parts: in the first six chapters a homogeneous incompressible gravitating liquid is postulated, and the shape investigated which it can assume, starting from a spherical form, and then endowed with rotation gradually increasing which causes it to assume a variety of shape, passing through the Maclaurin spheroid into the Jacobian ellipsoid, and this again into the Poincaré pear-shaped figure, finally breaking cataclysmically into two parts, a main body and its satellite, or the state of a double star, the final object of Darwin's research.

In these last two investigations the mathematical difficulties are almost insurmountable, and extraordinary approximations are required to arrive at any definite result, and even then the methods are not of universal acceptance, and much controversy has been excited.

The difficulty of the existence of a free surface, and its stability, is the chief impediment to progress; and the various stages are very instructive in revealing the branch points where the class of surface changes place.

Throughout the subject the angular velocity ω appears involved with the density ρ , in the form of the fraction $\frac{\omega^2}{2\pi\rho}$, so that ρ is here the astronomical density, of the dimensions of the square of an angular velocity, or (time)⁻². Astronomical density ρ is converted into C.G.S. density δ (g/cm³) by the factor G , the constant of gravitation, $G = 666 \times 10^{-10}$, according to the experiments of C. V. Boys, and then the fraction becomes $\frac{\omega^2}{2\pi G\delta}$. The astronomical unit of mass is then $\frac{1}{G} = 10^7 \times 1.5$, g, or 15 metric tons.

This fraction can be made more intelligible physically by introducing Maxwell's idea of the grazing satellite of the stationary spherical globe: then if K is the grazing velocity, and r_0 the radius

of the globe, $\frac{K^2}{r_0} = g = \frac{4}{3} \pi G \delta r_0$; and if Ω denotes the angular velocity of the satellite, $\Omega^2 = \frac{K^2}{r_0^2} = \frac{4}{3} \pi G \delta$, which is independent of the radius r_0 ; and then the fraction

$$\frac{\omega^2}{2\pi\rho} = \frac{\omega^2}{2\pi G\delta} = \frac{\omega^2}{\frac{2}{3}\Omega^2} = \frac{2}{3} \left(\frac{\omega}{\Omega}\right)^2,$$

to which a definite physical meaning can be attached.

If the globe could retain its spherical shape when the angular velocity was raised to Ω , bodies at the equator would be lively on the surface, like the mud particles on the top of the wheel of the old hansom cab seen through the side-window, and everywhere else the plumb-line would be parallel to the polar axis.

For the Earth this must be 170-fold, $\Omega = 17\omega$.

Maxwell suggested as the universal unit of time, for the Solar System, and all space beyond, the period of the grazing satellite of a sphere of water, instead of such a parochial unit as our terrestrial mean solar day; this new unit proves to be about 200 minutes.

It would be impossible to go into details here of the extraordinary audacity of the mathematical attack; a mere summary of the results must suffice, considered under the heads of

I. The Tidal Problem. II. The Rotational Problem. III. The Double Star Problem.

Starting with the gravitating globe at rest, in the Tidal Problem the motion is through a series of prolate spheroids: in the Rotational Problem the motion is first through a series of oblate spheroids (Maclaurin's spheroids) and then through a series of ellipsoids (Jacobi's ellipsoids): in the Double-Star Problem the motion is through a series of ellipsoids.

The second half of the essay undertakes an additional difficulty in developing a general theory of the configurations of equilibrium of a compressible mass, in its departure from the state predicted in an incompressible model.

Here the difficulty is great enough when rotation is absent, and the gas is stratified spherically, and various plausible physical assumptions must be made to allow the equations to be integrable. Dr. Schuster's results from the limiting case of $\gamma = 1.2$ are of very great importance, but a closer examination seems required to show that the agglomeration would be unstable at the core, if a rotation was imparted.

The object of this investigation of a compressible mass is to frame some theory of the internal state of density in the Spiral Nebulæ visible in the telescope, conjectural Solar Systems in the making; a feeler into Space, like Relativity, but without abandoning Newtonian Dynamics.

The whole essay is a direct frontal attack on impregnable problems, and will require to be reinforced by outflanking equations of related problems that will yield to solution.

Researches in Physical Optics. Part II. Resonance Radiation and Resonance Spectra. By R. W. WOOD, LL.D., Professor of Experimental Physics, Johns Hopkins University. New York: Columbia University Press, 1919. 184 pp., 10 plates.

[Publication number eight of the Ernest Kempton Adams fund for Physical Research.]

PART I of this Research, published 1913, was devoted to the radiation of electrons. An adequate description in detail of this monumental Research in Part II would take up more space of the Magazine than can be spared between the multiplicity of subjects. A mere outline of the scope must suffice for the reader.

The author is the best known exponent of the experimental side of the Science of Light in Physical Optics, and his contributions to the applications of Theory in recent warfare will it is hoped be allowed to see the light now, for the general benefit of Science.

Of the whole gamut of the light spectrum only a fraction can be apprehended by the human eye; but the author has succeeded in devising apparatus for picking up an impression of the part beyond the visible rays, and utilising them in operations such as heliographic work; the signals can then be received without attracting outside undesirable attention, as of an enemy.

We have been hearing much lately of the new Theory of Relativity, as revealed in the Gravitation of Light, so that it is no longer a paradox to say that Light is Heavy. In utilising the dark rays, the author provides a discussion of the Light that is Dark.

The Research is chiefly a careful description of the delicate apparatus required in the experimental work of the spectroscope. Nothing is recorded that has not been observed directly, and that is capable of being redetermined from a description of the apparatus. No appeal is made to new theories of the æther, and there are no elaborate mathematical developments, founded on conjectural hypothesis; nothing to spoil the pleasure of the physical experimenter, and to interrupt his manipulative skill and interest.

A Table of the Contents may be cited to show the scope of the investigations.

1. Plane Grating Spectrographs of Long Focus.
2. The Resonance Spectra of Iodine.
3. Resonance Spectra of Iodine.
4. The Series of Resonance Spectra.
5. Band and Line Spectra of Iodine.
6. Zeeman-Effect for Complex Lines of Iodine.
7. A Photographic Study of the Fluorescence of Iodine Vapour.
8. The Magneto-Optics of Iodine Vapours.

9. The Fluorescence of Gases Excited by Ultra-Schumann Waves.
10. A Further Study of the Fluorescence produced by Ultra-Schumann Rays.
11. Scattering and Regular Reflexion of Light by an Absorbing Gas.
12. Separation of Close Spectrum Lines for Monochromatic Illumination.

Unified Mathematics. By L. C. KARPINSKI, HARRY Y. BENEDICT, JOHN W. CALHOUN, Professors in the University of Michigan and Texas. D. C. Heald & Co., 1918. 522 pp.

PERRY'S 'Practical Mathematics' would be our equivalent for the scope of this book, intended to show, here and in America, that the old plan is obsolescent of keeping a school-boy marking time for years over arithmetic and algebra, and then rushing him through some Calculus and Coordinate Geometry in his last year. But the essentials of the Cartesian geometry are inculcated here in the use of squared paper, for drawing the simple graphs, and the illustrations follow of the geometrical applications of the Calculus.

The logarithm is introduced at an early stage and its use exemplified in multiplication and division in applications of real interest to large numbers and decimals by the aid of a compact four-figure table. But there is no mention of the Slide Rule, equivalent of a three-figure table, and amply accurate for ordinary purposes. Formerly the only table to be found was a seven-figure table, never hardly to be seen. It makes us groan when we have occasion to turn to it, to think how late in life the use of it was introduced to our attention.

In a first introduction to the logarithm, no base should be mentioned except 10, and then the definition $y=10^x=\text{al } x$, $x=\log y$, with the abbreviation (al) for antilogarithm, as (log) for logarithm. A four-figure table requires the antilogarithm to make both ends of equal accuracy, and with experience the (al) function can be made to serve throughout in place of the (log) function. But the heedless boy will not observe the distinction, so that many a schoolmaster will paste down the antilogarithm table.

An antilogarithm table is soon calculated, by the ordinary rules of arithmetic; thus y is calculated for $x=0.5$, 0.25 , 0.75 , by ordinary square root, for $x=0.2$ by Horner's method, and then for $x=0.1$, by square root; and no series is required.

The historical note on p. 183 seems to show that the Babylonian clay tablet might have a different reading, as the fraction of the illuminated part of the moon's surface is the half versed sine (hav) of the age of the moon. We still employ the Turkish astronomy in speaking of a new moon, and her age.

The polar coordinates, as exemplified on p. 436, should be laid out on the Lissajous's system, as they would be in Cartesians for

tuning-fork curves; taking equal angular steps, and then dropping perpendiculars on the initial line to set off the radii of the concentric circles.

In a Greekless age the Greek alphabet must not be left undefined. And we find no description of the Vernier or Nonius.

The whole book is very elegant and stimulating, and carries Perry's pioneering ideas to a high stage of development and pitch of perfection.

An Elementary Course of Infinitesimal Calculus. (Revised Edition.)

By HORACE LAMB, Professor of Mathematics in the Victoria University of Manchester.

Cambridge: at the University Press, 1919. 530 pp.

THE large page and clear spaced print will be much appreciated by the reader, and the diagrams are frequent enough to give reality to the argument. The author is happily not of the school of Lagrange, in banishing appeal to the eye in a geometrical figure.

He does not get to work in the Differential Calculus, as understood formerly, till Chapter II. A preliminary Chapter I seems written in fear of the school of Rigour, and explains at length the modern abstractions of continuity, sequence, convergency, discontinuity, and the limit, before the beginner has had occasion to form any concept of their meaning. "Man must act first, before proceeding to discuss the rationale of his activities."

An experienced old-fashioned instructor is likely to recommend a skip of this chapter on to Chapter II, reserving the consideration of the abstruse ideas of Chapter I till the need has arisen in the mind of the learner. It is well not to raise a difficulty in the mind of the beginner, until it has found a place in his own thought.

The differential coefficient defined in Chapter II is given a geometrical interpretation; but the author does well to introduce immediately another illustration, as the expression of a velocity; this will appeal to most minds more powerfully as a physical realization.

The author takes a very cautious, but useful, line of treatment in Chapter III of the Exponential Theorem and Function, and its inverse, the logarithm: and here again he goes in fear of attack from young Rigour, but entrenches himself very skilfully; making a start from the Differential Equation which defines the function.

Applications follow in Chapter IV of the functions employed in the course of the treatise, algebraical, circular, exponential, logarithmic, hyperbolic, direct and inverse.

Successive differentiation is treated in Chapter V, with its geometrical application to curvature, so that Integration is not reached till Chapter VI.

A daring pioneer, of the Perry type, is required to bring Integration into its proper priority of historical order, as senior to Differentiation by a thousand years. The idea of integration is less abstract and easier for the mind to grasp, when treated from first principles as the total growth of a quantity; instead of its rate of growth at any instant as expressed by the differential coefficient.

But first principles are difficult of application, and require special treatment for each particular case, so that for rapidity of progress in the applications, Integration is taught as a process of Anti-differentiation, the method inculcated in Chapter VI.

The picture of the process of Integration as a Quadrature follows in Chapter VII, explaining the operation from first principles in its proper historical order; and detailed geometrical applications follow in Chapter VIII, exemplified by the calculation of area, in Cartesian and polar coordinates, and by use of the Planimeter, of volume and surface, of the rectification of an arc, of mean centre, our old friend centre of gravity; the theorems also of Pappus, A.D. 300.

The student at this stage will begin to find himself in the subject, after working at the carefully selected collection of examples.

Juggling with curves (instead of letters) is the scornful name sometimes given to the geometrical applications by the pure analyst, anxious to get to work on his favourite detail of the Failure of Taylor's Theorem. But where else is the student to learn about this subject, so important for its applications in the higher branches, except in a systematic treatment such as given here in Chapters IX, X.

The last quarter of the volume takes up Differential Equations, and so renders unnecessary a separate study in another volume, of terrifying size and association, looming in store ahead.

Most of this terror could be cured, or would not arise, if the author would introduce at the earliest stage the mere name Differential Equation, and the associated elementary ideas. Then the beginner could be assured that he had been working unconsciously at differential equations from the start; and that the laws of mechanical nature are revealed to us in the Differential Equation. The separate individual problem merely assigns the constants of the equation.

On this plan the simplest integrations would be asked for as the solution of a differential equation; as for instance of the differential equations

$$\frac{dy}{dx} = x, \quad x^2, \quad \sqrt{x}, \quad \frac{1}{\sqrt{x}}, \quad \frac{x-a}{\sqrt{(x-b)}}$$

with a drawing of the graph, and of the singular solution, as a tac, cusp, or node locus; and so on.

And Differentiation would be called the formation of the differential equation, by the elimination of the constant.

The author himself employs this idea in Chapter III, where he proposes the differential equation $\frac{dy}{dx} = y$, or ky , as the definition of the exponential function. In the associated graph the curve has a constant subtangent.

A feature of the treatment is the banishment of Taylor's Theorem to the end of the book. This will prevent young Rigour from keeping his class marking time ever so long over the Failure of Taylor's Theorem, all he seems to care about. But the beginner is delighted with the theorem when he finds it gathers up all the preceding isolated expansions of his functions of a real variable in a series, and gives him a method he can employ with suitable precautions for the numerical calculation of his function, to any desired accuracy.

The Sublime Calculus was the former noble name of our subject, replaced to-day by Infinitesimal. It is treated here with a view of immediate application, as well as for the benefit of the mathematician on his road to higher developments. Scores of lowly treatises are in use, to minister to the immediate wants of the engineer and electrician, with their presentation from the direct commercial aspect. These all shirk such abstractions as the ideas explained in Chapter I here.

XXXVII. *Proceedings of Learned Societies.*

GEOLOGICAL SOCIETY.

[Continued from vol. xxxviii. p. 748.]

November 5th, 1919.—Mr. G. W. Lamplugh, F.R.S., President,
in the Chair.

A Lecture was delivered by HUGH HAMSHAW THOMAS, M.A., F.G.S., 'On some Features in the Topography and Geological History of Palestine,' illustrated by aeroplane photographs taken during the War.

The Lecturer observed that a perfectly new method of illustrating and investigating some branches of physical geology is afforded by Aeroplane Photography. It seems firstly to illustrate in a very striking and convincing form many geological phenomena, such as the structure of a volcano or the land-forms resulting from erosion, and may be of value in the teaching of the science. In the second

place it may, in certain circumstances, become a valuable means of research, especially in connexion with river-development or denudation in a region which is somewhat inaccessible, or where the surface of the ground is very complicated and the main features are obscured by a mass of less important detail. The lecture deals principally with the illustration of the physical features of Palestine, and owes its origin to the systematic photo survey made over Central Palestine during the War. The photographs were originally taken for the purpose of constructing detailed maps, and the examples shown have been selected from a large mass of similar material which still exists in the form of negatives, and these may eventually become available in this country for further study and research. The demarcation of the coastal plain from the foot-hills of the upland country is often well shown by oblique air-photographs, and the weathering-out of the flat alluvial ground by the winter rains to give characteristic wadis is clearly seen. In the central hill-country the terraced hills show the relation of the scenery to the underlying rock, but their general sculpture is regarded as belonging to a former period of great precipitation. In arid country, where the underlying rock is laid bare, the aeroplane camera often shows the general geological structure of the district.

The lacustrine deposits of the Jordan Valley and their weathering was shown, and also the form of the drainage-channels running down into the main valley. The depression of the Dead Sea with reference to the surrounding country has resulted in cañon formation in many places. Some evidences of faulting at different periods can be distinguished.

The Jordan at present forms an interesting study in river-development, and many of its main features were demonstrated. The relation of the Jordan to the Orontes has been considered, and an aeroplane photographic survey of the country between the two rivers indicates that the Jordan probably originated in Northern Syria in earlier times. The Syrian portion of the stream has been captured by the younger Orontes, and this has had a very important effect on the whole topography of the Jordan Valley.

A further study of the aeroplane photographs already taken, and of the maps made from them, may throw much new light on the questions of climatic changes and of topographical changes due to faulting in Palestine.

THE
LONDON, EDINBURGH, AND DUBLIN
PHILOSOPHICAL MAGAZINE
AND
JOURNAL OF SCIENCE.

[SIXTH SERIES.]

APRIL 1920.

XXXVIII. *The Determination of the Rate of Solution of Atmospheric Nitrogen and Oxygen by Water.*—Part II. By W. E. ADENEY, D.Sc., A.R.C.Sc.I., F.I.C., Acting Professor of Chemistry in the Royal College of Science for Ireland; and H. G. BECKER, A.R.C.Sc.I., Research Student*.

I. INTRODUCTION.

IN the first part of this communication † a method of studying the rate of solution of air by water was described, and some results were given, which showed that, when the water was kept thoroughly mixed and the water-air surface unbroken, the phenomenon took place in accordance with the general equation

$$\frac{dw}{dt} = a - bw,$$

in which a represents the initial rate of solution, and bw the rate of escape of the gas from the water, b being a constant depending on the conditions of the experiment.

The method of experimenting consisted in enclosing a large bubble of air, of known volume, in a narrow tube containing de-aerated water, and allowing the bubble to pass

* Communicated by the Authors. From the Scientific Proceedings of the Royal Dublin Society, vol. xv. (n. s.) No. 44, Sept. 1919.

† Scientific Proc., R.D.S., vol. xv. p. 385 (1918); Phil. Mag. xxxviii. p. 317 (1919).

up through the water repeatedly until saturation was reached. The pressure in the bubble was measured after each double passage up the tube by means of a water manometer, and this gave data for calculating the absorption which took place step by step to saturation.

With the object of reducing the observations to unit area and volume, experiments have been continued along these lines, and the results are given in this communication. The apparatus employed for these later experiments has been modified in a manner which experience showed was necessary; and the determinations have been extended to include oxygen and nitrogen as pure gases.

II. TEMPERATURE CONTROL.

In the experiments previously recorded the temperature of the apparatus was maintained constant by providing a large reservoir of water, and allowing the water to run through the water-jacket of the apparatus while the observations were being made. This method only allowed of the maintenance of a steady temperature for a few hours, and experiments could not be repeated at the same temperature at will, nor could higher temperatures than that of the room be obtained.

In order to bring the temperature under control, it was decided to use a thermostat, and circulate the water from it through the water-jacket of the apparatus. To provide the circulation of water a small centrifugal pump was designed, patterns were made and castings obtained from the Engineering Department of the College, while the machining was completed in the workshop attached to the Chemical Department.

This pump maintained a rapid stream of water through the water-jacket at a constant rate; and no difficulty was experienced in keeping the temperature constant to within $0^{\circ}.1$ C. A further advantage was that any desired temperature within fairly wide limits could be attained, and experiments could be repeated as often as desired at the same temperature on different days.

III. EXPERIMENTS TO DETERMINE THE EFFECT OF THE AREA OF THE BUBBLE ON THE RATE OF SOLUTION.

(a) *Measurements of the lengths of different bubbles in motion.*

Bubbles of five different volumes were measured at 25° C. while in motion up the tube. Arrangements were made for

photographing each bubble and the scale in close proximity to each other, through the water-jacket, by providing a scale ruled on thin tracing-paper, and cementing this to the inner tube with Canada balsam. This scale was almost transparent, and the image of the bubble was orthographically projected on to it by means of a beam of parallel light from an arc lamp. The camera was focussed sharply on the scale, and the shutter was released just as the bubble passed behind the scale, so that on the negative the scale lines were superimposed upon the image of the bubble.

These negatives were measured by means of a travelling microscope, and the measurements referred to the paper scale, the errors of which were determined by means of a standard scale both before and after use. The length of each bubble, when at rest, was measured with a mirror scale, which was also compared with the standard scale, and the area of the bubble was calculated from the formula deduced in the first part of this communication. The results of the measurements are given in Tables I. and II.

TABLE I.

Measurements of Bubbles of Different Volumes.

Temperature.	Volume.	Length in Motion.	Length at rest.
25° C.	15.0 c.c.	15.98 cm.	13.25 cm.
„	12.5 „	13.61 „	11.10 „
„	10.0 „	11.11 „	8.85 „
„	7.5 „	8.48 „	6.70 „
„	5.0 „	5.90 „	4.45 „

TABLE II.

Calculation of Areas.

Volume.	Diameter.		Thickness of wall.	Area.
	External.	Internal.		
15.0 c.c.	1.20 cm.	1.099 cm.	.050 cm.	56.33
12.5 „	„	1.091 „	.055 „	47.58
10.0 „	„	1.086 „	.057 „	38.85
7.5 „	„	1.078 „	.061 „	29.63
5.0 „	„	1.058 „	.071 „	20.52

(b) *Effect of temperature on the length of the bubble in motion.*

A number of measurements were also made of the length of the 15 c.c. bubble at different temperatures, and the results are recorded here; for, although they appear to have no direct bearing on the object of the inquiry, they may be of use in throwing light on the nature of the motion of the bubble up the tube.

A 15 c.c. bubble was drawn into the tube at each of the temperatures given, and allowed to attain atmospheric pressure at that temperature by opening the tap connecting it with the air. The tube was then inverted several times and the tap opened after each inversion to make sure that the pressure in the bubble was atmospheric. The bubble was then photographed, and the negative measured in each case.

TABLE III.

Measurements of 15 c.c. Bubble at Different Temperatures.

Temperature.	Length.
11° C.	16·15
25°	15·98
30°	15·91
35°	15·85
40°	15·81

These measurements show that the length of the bubble decreases with rise in temperature; but since the volume must be constant, the diameter must increase as the length diminishes, hence the area will not be affected appreciably by this change in length.

(c) *Effect of the area of the bubble on the rate of solution.*

To determine the effect of the area of the bubble on the rate of solution a series of five duplicate experiments was carried out at 25° C., using bubbles of 5, 7·5, 10, 12·5, and 15 c.c. The experiments with the first two bubbles were made in a tube of 50 cm. length, as it was thought that too large a fraction of the whole volume of air in the bubble would be absorbed in one double passage up the 100 cm. tube. From these experiments, the values of a and b were calculated, as described previously*, from the graph obtained by plotting the rate of solution against air-content.

* Part I. of this communication.

The observations were reduced to a uniform volume of 100 c.c., and the lines representing the mean of each pair of experiments are given in fig. 1. It will be seen that they tend to meet in a point on the x -axis, this point representing the saturation value of the water for the temperature of the experiment. The agreement between the different values for this quantity is shown in the column headed " w_0 " in Table IV.

Fig. 1.

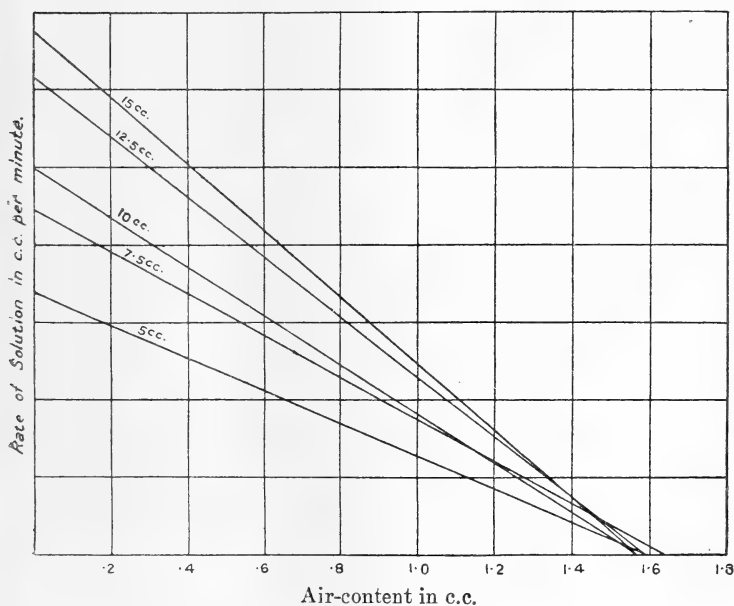

TABLE IV.

Results of Experiments with Air in Bubbles of Different Volumes at 25° C.

Volume.	Area.	Value of a .	Value of w_0 .	Value of b .
5 c.c.	20.52 sq. cm.	.342	1.59	.215
7.5 „	29.63 „	.450	1.64	.274
10 „	38.85 „	.497	1.57	.317
12.5 „	47.58 „	.620	1.59	.390
15.0 „	56.33 „	.680	1.57	.433

When the values of b are plotted against the area, as in

fig. 2, a straight line graph is obtained which intersects the axis of x in a point lying to the left of the origin. Hence the absorption is not directly proportional to the area of the bubble. This appears to be due to the fact that the conditions which apply to the cylindrical portion of the bubble

Fig. 2.

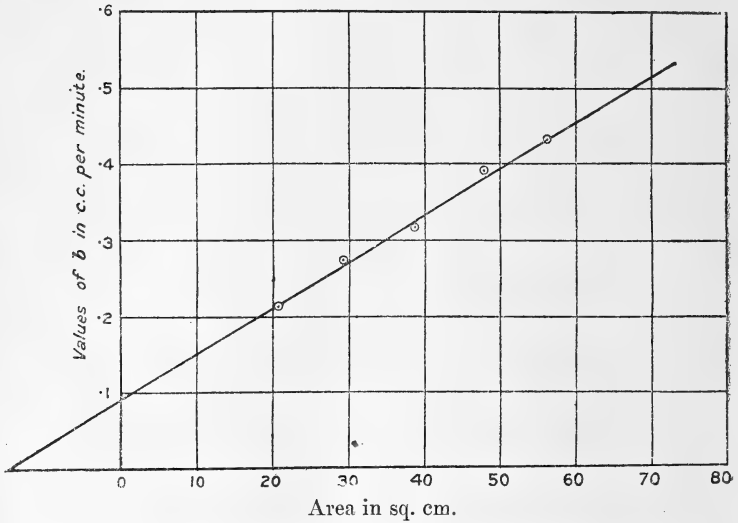
Values of b plotted against area of bubble.

do not hold for the hemispherical head. The rate at which the water streams past the head of the bubble is much less than that at which it passes down the cylindrical portion of it; hence the absorption due to the head of the bubble is greater than might be expected from its area. These two effects are differentiated by measuring the rate of absorption for a number of different bubbles; because, since the effect of the head of the bubble is the same in each case, the variation in absorption must be due to variation in the area of the cylindrical portion. Hence the graph shows the rate at which the value of b increases with increasing cylindrical area. By producing the graph until it cuts the x -axis we obtain a constant correction for the head of the bubble, which, when added to the calculated area of the bubble, gives the effective area when the absorption is uniform all over the surface.

The value of the intercept on the x -axis is 15 sq. cm.; hence this amount must be added to the area of each bubble.

TABLE V.

Volume.	Calculated Area.	Effective Area.
5 c.c.	20.52 sq. cm.	35.52 sq. cm.
7.5 "	29.63 "	44.63 "
10 "	38.85 "	53.85 "
12.5 "	47.58 "	62.58 "
15 "	56.33 "	71.33 "

IV. EXPERIMENTS TO DETERMINE THE EFFECT OF TEMPERATURE ON THE RATE OF SOLUTION OF ATMOSPHERIC AIR.

A series of seven duplicate experiments was made within a temperature range of 3°·6 to 38°·4 C. with atmospheric air in a 15 c.c. bubble. These experiments were carried out by the method described in the first part of this communication, with slight modifications, and the results are given in Table VI. and fig. 3.

Fig. 3.

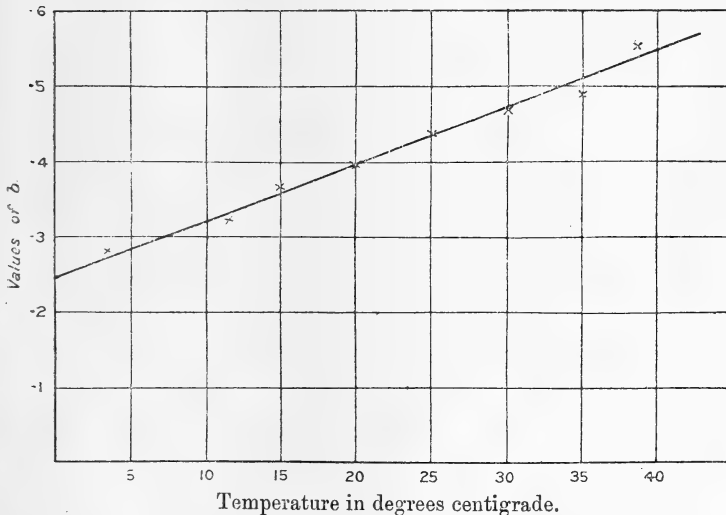

Values of *b* for air plotted against temperature.
Formula: $-b = .0075(T - 240.1)$.

Examination of these results showed that, when the temperature of the water-jacket was widely different from that of the room, this method did not give sufficiently accurate values for the saturation-point.

In fig. 3, the mean values of *b* are plotted against

392 Prof. Adeney and Mr. Becker: *Determination of Rate of* temperature, giving a straight line with the formula $b = .0075(T - 240.1)$. This will be referred to when finally considering the results.

TABLE VI.
Results of Experiments with Atmospheric Air.

Temperature, °C.	Values from log graph.		Values from W_0 graph.			Saturation Values.		Mean Value of b .
	t .	b .	a .	W_0 .	b .	Dittmar.	Sum of Readings.	
3.6	71	.266	.750	2.720	.296	2.534	2.682	.281
11.4	—	—	.645	2.060	—	—	2.074	—
11.3	54	.336	.675	2.115	.312	2.126	2.131	.324
15.0	—	—	.695	1.730	—	—	1.806	—
15.0	47	.397	.650	1.640	.338	1.988	1.614	.367
20.0	—	—	.700	1.640	—	—	1.663	—
20.0	44	.431	.640	1.500	.368	1.818	1.484	.399
25.0	—	—	.720	1.570	—	—	1.573	—
25.0	40	.459	.650	1.380	.411	1.672	1.381	.435
29.6	—	—	.640	1.265	—	1.555	1.267	—
29.3	36	.523	.660	1.320	.421	1.564	1.300	.472
34.2	—	—	.585	1.060	—	1.457	1.017	—
34.4	32	.580	.595	1.010	.406	1.453	0.934	.493
38.5	—	—	.630	0.865	—	—	0.845	—
38.6	28	.665	.585	0.785	.446	1.360	0.787	.555

V. IMPROVEMENTS IN METHODS OF EXPERIMENTING.

When the form of apparatus, described in Part I. of this communication, was employed in experiments at temperatures much above or below room-temperature, a number of possible sources of error might be expected to affect the results, viz.:—

1. Difference of temperature between the water-jacket and the air drawn in to renew bubble.
2. Absorption of air during periods of manipulation.
3. Difference in temperature between the air in the bubble and that in the air-space of the manometer.

Of these it seemed that No. 1 was the most important; No. 3 was extremely small; while subsequent experiments have shown that No. 2 is negligible, with a narrow tube, such as was used in these experiments.

In order to eliminate these errors it was decided to make a new form of apparatus, suitable for use with a pure gas, such as nitrogen or oxygen; and to work with air-free water.

(a) *Preparation of Air-free Water.*

In order to ensure that the water was air-free, it was necessary to boil it in the vacuum of the mercury pump, and then transfer it to the experimental tube without allowing it to come in contact with the air. At first it was thought that it would be sufficient to heat the water until its vapour-pressure was great enough to force it over into the tube, but it was found that this necessitated much too high a temperature. It was decided to displace the water with mercury, but this introduced such a narrow tube between the flask and condenser that the condensed vapour blocked it.

The difficulty was finally solved by providing a second tube to allow the water condensed to flow back into the flask. It was thus possible to boil the water in vacuo as long as might be necessary, without any appreciable loss by evaporation.

The diagram (fig. 4) shows the form of apparatus used, and the mode of operation is as follows:—The water in *A* is heated to a fairly high temperature by means of a water-bath, and the mercury pump is then worked until a very low pressure is reached. In this way most of the gas is extracted in the first violent ebullition, and the remainder is removed by continued boiling under the reduced pressure. During the latter part of the operation the water bumps very violently, with the result that some of it is thrown over into the vessel *E*; but this returns to the flask immediately by the tube *B*, as also does any water dripping from the condenser. When all the air is extracted, the pinch-cocks *B* and *C* are closed, and *D* is opened, when the mercury flows in and displaces the water into the experimental tube, which has been previously filled with mercury, and connected to the flask *A* by another tube not shown in the drawing. All the rubber stoppers used were protected from leakage by mercury traps, and the rubber tubing was varnished with shellac to prevent diffusion.

(b) Modified form of Experimental Tube used.

Owing to the difficulty in obtaining apparatus, it was decided to make the required modification of the experimental tube in the laboratory. It was designed and made as shown in the diagram (fig. 5). At the upper end of the

Fig. 4.

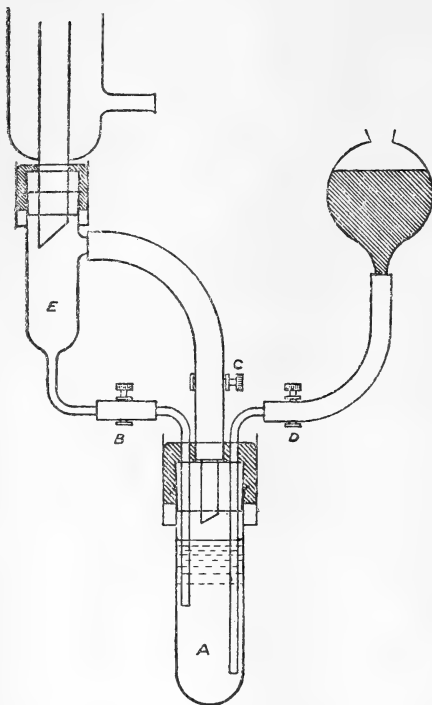
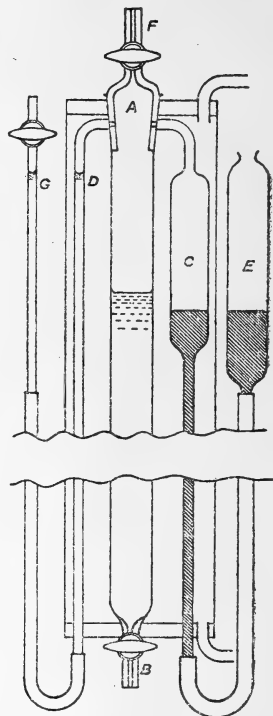

Fig. 5.



tube there is a hollow stopper *A* ground in, which controls the connexion to the manometer *D* and the gas reservoir *C*. This stopper also has a stopcock *F*, fused on to it at the top to permit of the tube being filled with water when used in conjunction with another stopcock *B*, fused on to the lower end of the tube. The manometer *D* and the gas reservoir *C* are fused on to the tube in such positions that the openings correspond with the holes in the stopper. The whole apparatus is provided with a water-jacket as shown, through the bottom of which the ends of the gas reservoir and the manometer project, in order to allow them to be connected

by rubber tubing with the mercury reservoir *E* and the tube *G*, respectively.

The manipulation involved in an experiment was as follows:—After the whole apparatus had been carefully cleaned, the manometer was filled with water and the tube filled with mercury by connecting on a temporary reservoir at *B*; at the same time the gas reservoir *C* was filled with mercury by raising *E*. The water-level in *D* was also raised to the hollow stopper, which was then turned so as to close all the side tubes. The tube was then connected to the boiling apparatus just described, by a capillary tube joined to stopcock *F*. The air was displaced from this connexion by forcing a little mercury over from the temporary reservoir. The water was then boiled until all the air was extracted, when the water was displaced over into the experimental tube, by lowering the reservoir of mercury attached to it, and raising that attached to the laboratory flask.

When the tube was quite full it was disconnected from the laboratory flask, and water from the thermostat was circulated through the jacket until the required temperature was attained. When a steady state was reached the stopcock *F* was connected to the reservoir of gas in use, and the stopcock *B* to a standard burette, and the correct volume of bubble drawn in. The gas reservoir *C* was then filled with the gas by turning the stopper so as to connect it with the bubble, and lowering the reservoir *E*; the manometer space was likewise filled by again turning the stopper and lowering the manometer tube *G*. The tap at *F* was then disconnected from the gas reservoir and opened and shut several times so as to bring the manometer to zero and the pressure in the bubble to that of the atmosphere. (The pressure in the bubble before this operation was always slightly *above* atmospheric, so that no air could enter.)

The tube was then ready for the observations which were made as usual after each double inversion. During the inversion the stopper was turned so as to shut all side tubes, and it was so arranged that after inversion the bubble could be connected to the manometer alone, to read the pressure, and then to the manometer and gas reservoir simultaneously, to allow of the pressure being re-adjusted to atmospheric, by manipulating the mercury reservoir *E* until the manometer went back to zero.

By means of this apparatus the difficulty about the temperature and vapour-pressure of the replenishing gas was overcome, because the gas was contained in the reservoir *C*

at the same temperature as that of the bubble, and there was sufficient moisture in the reservoir to keep the gas saturated with aqueous vapour at that temperature.

When the observations were completed, the lower tap *B* was connected to the gas pipette described in Part I. of this communication, by means of a piece of rubber tubing filled with mercury, and the water in the tube was run into the pipette to allow of its transfer to the pump for the determination of its gas-content without exposure to the atmosphere.

Using this apparatus, a number of experiments were made with both nitrogen and oxygen, the results of which are given below.

VI. EXPERIMENTS WITH PURE GASES.

(a) *Experiments with Nitrogen.*

The nitrogen used was prepared according to a method recommended by Knorre*, and said to give no oxides of nitrogen.

A mixture of 30 grams sodium nitrite, 30 grams potassium bichromate, and 45 grams ammonium sulphate, was dissolved in about 500 c.c. water, and placed in a litre retort. This was connected to three bulb tubes, the first containing a mixture of 5 vols. of a saturated solution of potassium bichromate to 1 vol. strong sulphuric acid; the second, dilute potassium permanganate solution; and the third, alkaline pyrogallol.

The whole apparatus was exhausted with a water-pump, and the liquid warmed until the pressure rose to that of the atmosphere, when it was again exhausted, and the process repeated. In this way the air in the apparatus was very completely removed. The gas was collected over water which had been boiled for some time, and allowed to cool out of contact with air.

A series of experiments over a range of 35° was made with this gas, and the results are given below.

The experimental figures were treated graphically in two ways. In one case the rate of solution was plotted against the mean value of the gas-content, and in the other the logarithms of the absorptions were plotted against the time intervals. Each set of graphs gave values for *a* and *b*, which are given in Table VII., and the mean of the values of *b* in each case is plotted against temperature in fig. 6.

* *Chem. Centr.* 1903, i. p. 125.

TABLE VII.

Results of Experiments with Nitrogen.

Temperature, °C.	Values from log graph.		Values from W_0 graph.			Saturation Values.			Mean Value of b .
	t .	b .	a .	W_0 .	b .	Adeney and Becker.	Winkler.	Bohr.	
3.5°	52	.270	.644	2.440	.264	2.230	2.180	2.240	.267
11.1	—	—	.568	1.800	—	1.830	1.822	1.922	—
11.3	44	.310	.558	1.830	.310	1.860	1.816	1.881	.310
15.0	—	—	.562	1.660	—	1.735	1.682	1.785	—
15.1	40	.344	.533	1.640	.332	1.741	1.680	1.780	.338
20.1	35.5	.403	.630	1.660	.380	1.556	1.530	1.625	.401
24.8	—	—	.646	1.480	—	1.476	1.416	1.490	—
24.8	33	.435	.569	1.590	.394	1.488	1.416	1.490	.414
30.4	32	.440	.600	1.360	.441	1.330	1.299	1.335	.440
35.1	29	.499	.608	1.260	.482	1.235	1.203	1.220	.490

Fig. 6.

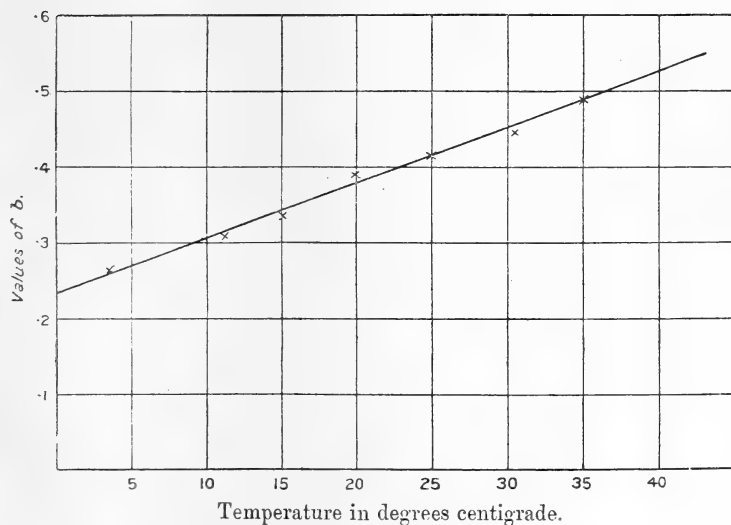

Values of b for Nitrogen plotted against temperature.

Formula :— $b = .00727(T - 240.8)$.

(b) *Experiments with Oxygen.*

The oxygen was prepared by heating potassium permanganate in a hard glass tube, and washing the gas with caustic potash to remove any traces of carbon dioxide which might be formed. The apparatus was exhausted several times with a water-pump to wash out the last traces of air. The gas was collected over water which had been boiled for some time and cooled out of contact with air.

A series of experiments was made over a range of temperature of 35°, and the results treated by the two methods as mentioned in the case of nitrogen. The results are contained in Table VIII., and the variation of *b* with temperature is shown in fig. 7.

TABLE VIII.

Results of Experiments with Oxygen.

Temperature, °C.	Values from log graph.		Values from W ₀ graph.			Saturation Values.			Mean Value of <i>b</i> .
	<i>t</i> .	<i>b</i> .	<i>a</i> .	W ₀ .	<i>b</i> .	Adeney and Becker.	Winkler.	Bohr.	
2.5	77	.252	1.235	4.47	.276	4.450	4.600	4.690	.264
8.8	64	.310	1.230	3.910	.315	3.814	3.970	4.080	.313
15.5	59	.336	1.140	3.330	.342	3.254	3.372	3.450	.339
20.2	54.5	.356	1.150	2.950	.390	2.970	3.040	3.110	.373
25.2	51	.392	1.150	2.810	.410	2.812	2.810	2.880	.411
30.3	46	.437	1.080	2.450	.432	2.485	2.510	2.575	.434
35.1	43	.477	1.120	2.250	.498	2.323	2.355	2.400	.487

In the above series of experiments the water in the tube at the end of each experiment was analysed for dissolved gases, using the extraction pump and measuring apparatus described in Part I. of this communication. The solubilities of oxygen and nitrogen at the given temperatures as calculated from these analyses are given in Table IX., as are also the values obtained by Bohr and Winkler by absorptometric methods.

TABLE IX.

Nitrogen.				Oxygen.			
Temp. °C.	Winkler.	Bohr.	Adeney and Becker.	Temp. °C.	Winkler.	Bohr.	Adeney and Becker.
3.5	·02139	·02200	·02203	2.5	·04540	·04625	·04390
11.2	·01788	·01890	·01820	8.8	·03866	·03965	·03710
15.0	·01654	·01757	·01701	15.5	·03323	·03405	·03206
20.1	·01505	·01598	·01549	20.2	·03019	·03089	·02955
24.8	·01392	·01461	·01456	25.2	·02733	·02805	·02732
30.4	·01276	·01312	·01322	30.3	·02488	·02552	·02465
35.1	·01183	·01200	·01220	35.1	·02302	·02347	·02270

Fig. 7.

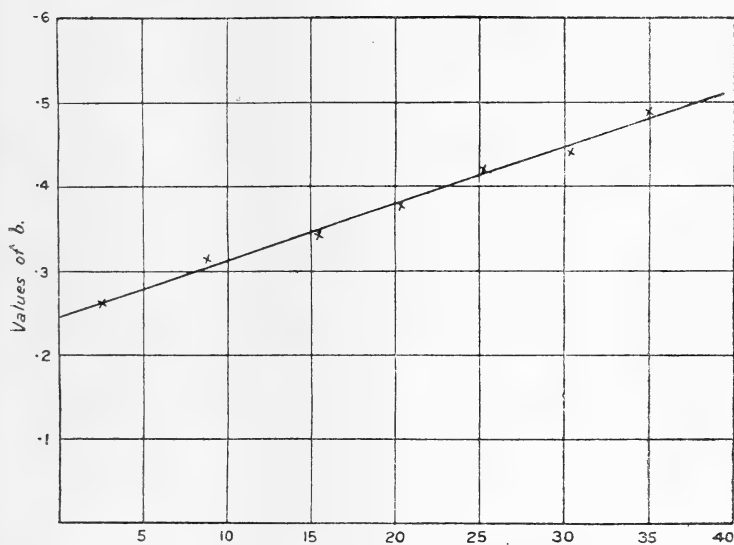

Temperature in degrees centigrade.

Values of b for Oxygen plotted against temperature.

Formula : $-b = .00672(T - 236.5)$.

VII. REDUCTION OF RESULTS TO UNIT AREA AND VOLUME TO OBTAIN FUNDAMENTAL CONSTANTS.

The results have been shown to be in agreement with the general formula

$$\frac{dw}{dt} = SAp - f \frac{A}{V} w,$$

where w = total quantity of gas in solution at any moment, S = the initial rate of solution per unit area, f = the coefficient of escape of the gas from the liquid per unit area and volume, A = area of surface, and p = pressure of the gas.

The values of b for different temperatures and different gases have been found for various temperatures using a volume of water of 101.8 c.c. and an exposed area of 71.3 sq. cm.; hence since

$$b = f \frac{A}{V},$$

we can calculate the values of f . The values are given in the second column of Table X., and when they are plotted against temperature in each case, three straight lines lying very close together are obtained, as shown in fig. 8.

Fig. 8.

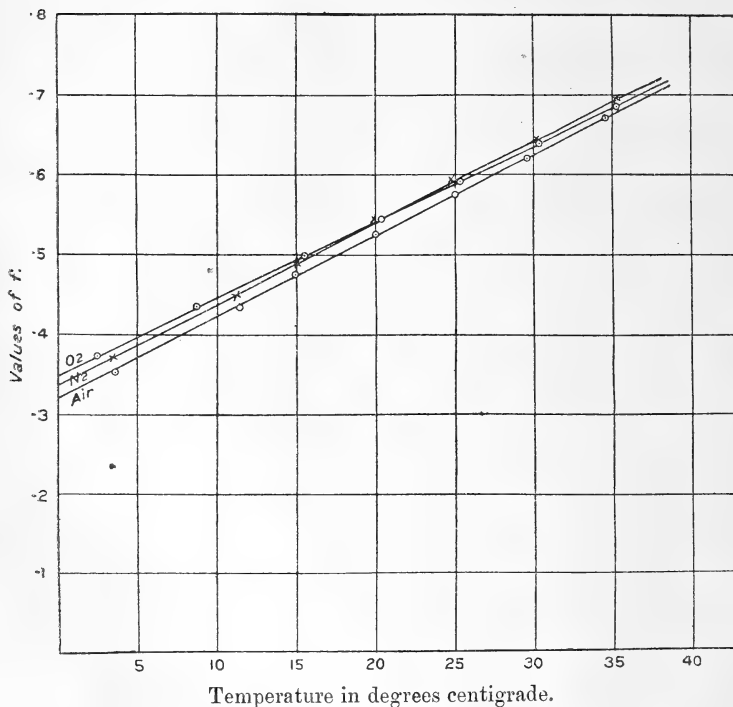

Values of f plotted against temperature.
 Formulæ:— $f = 0.0096 (T - 236.5)$ for Oxygen.
 $f = 0.0103 (T - 240.0)$ for Nitrogen.
 $f = 0.0099 (T - 239.3)$ for Air.

When the values of f for any gas are multiplied by the corresponding solubilities, the product gives the initial rate of solution in each case, since $S=fs$. It will be seen by reference to Table X. that the value of S is practically a constant over the range of temperature given.

The value of S is approximately proportional to the solubility, being about twice as great for oxygen as it is for nitrogen; and if $\frac{4}{5}$ of the value for nitrogen be added to $\frac{1}{5}$ of that for oxygen, a value for air is obtained which agrees fairly closely with the actual figures thus:— $\frac{4}{5}$ of $\cdot0083 + \frac{1}{5}$ of $\cdot0160 = \cdot00665 + \cdot00320 = \cdot00985$, while the mean experimental figure is $= \cdot0100$.

TABLE X.

Temp. °C.	Oxygen.		$S=fs$.
	f .	s . from analysis	
2.5	·373	·04390	·0164
8.8	·434	·03710	·0161
15.5	·499	·03206	·0160
20.2	·545	·02955	·0161
25.2	·591	·02732	·0161
30.3	·641	·02465	·0158
35.1	·687	·02270	·0156

Nitrogen.

3.5	·372	·02203	·0082
11.2	·448	·01820	·0081
15.0	·490	·01701	·0083
20.2	·543	·01549	·0084
24.2	·593	·01456	·0086
30.4	·647	·01322	·0085
35.1	·696	·01220	·0085

Air.

		(Dittmar.)	
3.6	·352	·02700	·0095
11.4	·441	·02260	·0099
15.6	·476	·02120	·0100
20.0	·525	·01930	·0101
25.0	·574	·01780	·0102
29.6	·623	·01660	·0103
34.3	·672	·01550	·0104

VIII. STATEMENT OF RESULTS.

From the figures given in the previous section it is possible to calculate the rate of solution of the gases dealt with, for any conditions of area exposed, depth, or degree of saturation, provided that the water is kept uniformly mixed.

The expression can be put either in the form

$$\frac{dw}{dt} = a - bw,$$

which gives the rate of solution at any instant, or in the form $w = (w_0 - w_1)(1 - e^{-bt})$, which gives the amount dissolved at the end of any given time when w_0 = saturation value and w_1 = amount of gas in solution initially. For practical purposes it is most convenient to work in percentages of saturation; hence the latter equation becomes $w = (100 - w_1)(1 - e^{-bt})$, and since

$$b = f \frac{A}{V}$$

by substitution

$$w = (100 - w_1) (1 - e^{-f \frac{A}{V} t})$$

as the general equation for any given temperature, and since f varies with temperature according to the equations

$$\text{Oxygen} \quad f = \cdot 0096 (T - 237)$$

$$\text{Nitrogen} \quad f = \cdot 0103 (T - 240)$$

$$\text{Air} \quad f = \cdot 0099 (T - 239),$$

the corresponding general equation for each gas by substituting these expressions in the formulæ is obtained, thus:—

$$\text{for Oxygen} \quad w = (100 - w_1) [1 - e^{-\cdot 0096(T-237) \frac{A}{V} t}]$$

$$,, \text{ Nitrogen} \quad w = (100 - w_1) [1 - e^{-\cdot 0103(T-240) \frac{A}{V} t}]$$

$$,, \text{ Air} \quad w = (100 - w_1) [1 - e^{-\cdot 0099(T-239) \frac{A}{V} t}].$$

As an example of the use of these formulæ, consider the question of the dissolved oxygen in 1000 c.c. water, area exposed being 100 sq. cm., temp. 20.5 C., and initial gas-

Percentage of Saturation.

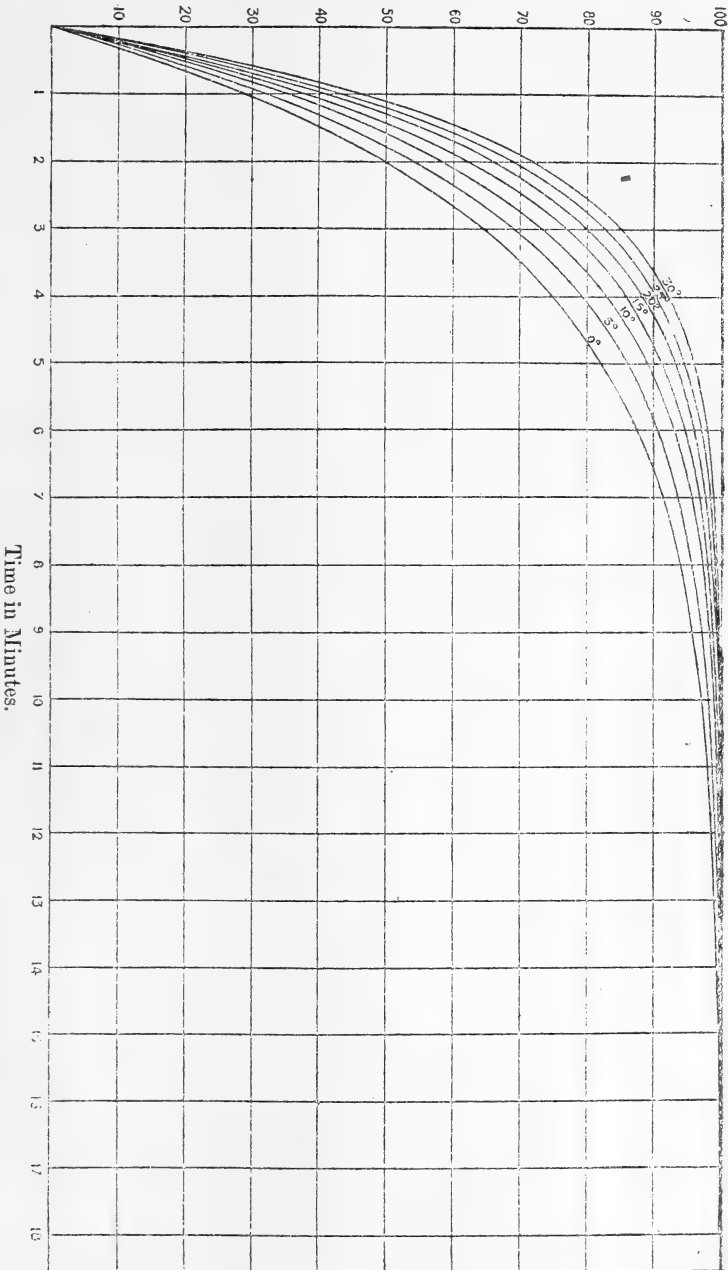

Fig. 9.

Curves for Oxygen, showing the variation of the gas-content of the water with time.
 Volume of water 1 c.c. Area exposed 1 sq. cm.

content=40 per cent. of saturation. How much gas will be dissolved in an hour?

$t=60$ minutes,

$$v=60(1-e^{-\frac{373}{10}t})=60(1-e^{-222})=60(1-0.8009)=60 \times 0.1991 \\ =11.8 \text{ per cent. saturation.}$$

Hence after an hour the water will have risen to 51.8 per cent. of saturation.

These equations can also be used to calculate curves showing the rate of solution in water of the different gases under different conditions, and as an example the curves for oxygen between 0° C. and 30° C. have been calculated in percentages of saturation, and are shown in fig. 9. It is noteworthy that when expressed in percentages of saturation, the curves for the three gases lie very close to each other, those for oxygen and nitrogen being practically identical.

The authors desire to express again their indebtedness to Dr. Hacket (Lecturer in Physics in this College) for the interest he has taken in this investigation, and the valuable assistance he has generously given in the mathematical treatment of the subject.

Chemical Department,
Royal College of Science for Ireland.

XXXIX. *On the Contributions to the Electric Current from the Polarization and Magnetization Electrons.* By Dr. A. D. FOKKER (*Leiden*)*.

AN important question in the electronic theory of matter is the evaluation of the electric current due to the motion of the electrons of electrically neutral atoms. To Minkowski the idea is due to put the question as a variation problem of a current by small virtual displacements, in a manner to be described hereafter. Born has worked out this idea after Minkowski's death †.

* Communicated by the Author. Abstract from a paper offered to the *Kon. Akad. v. Wetensch.* at Amsterdam.

† Hermann Minkowski—Max Born, *Eine Ableitung der Grundgleichungen für die elektromagnetischen Vorgänge in bewegten Körpern*, *Math. Ann.* lxxviii. p. 526, 1910.

I venture to offer a new development of the same idea, which distinguishes itself by the extreme simplicity of the means employed. No use is even made of any theorem from the theory of relativity. After completing the deduction, nevertheless, it is easy to show the covariancy of the equations obtained in the sense of the theory of general relativity.

In addition, one hits on a contribution of the bound electrons hitherto not yet signalized, so far as I am aware (§ 7).

§ 1. *Minkowski's Idea.*

Consider a stream of neutral atoms. For simplicity's sake we shall take them to consist of a positive nucleus and one accompanying electron, both of them carrying the elementary charge. The motions of the heavy nuclei will be identified with the motion of matter, and we shall assume that neighbouring atoms will be very nearly similar and similarly situated, so that the functions defining the positions of the electrons relative to their nuclei, though not strictly constant, will vary but slowly from one atom to the next.

Of course the stream of positive nuclei will constitute an electric current, and the stream of electrons another. As a result of the displacements of the latter relative to the nuclei their current will not have the same intensity as the positive current from the nuclei. The combined effect will be the current required in the field equations for ponderable matter.

It will be clear that if, given the displacements, we succeed in finding the resulting variation of intensity of the stream, our problem will be solved, as soon as we shall have interpreted the result in terms of physical quantities such as polarization and magnetization.

The displacements can be regarded as depending on a variational parameter θ . It turns out that the terms in the result proportional to θ are connected to the polarization, and that the terms proportional to θ^2 express the effect of magnetization mainly.

§ 2. *The displacements.*

We imagine a stream of particles moving through a space which will be described by the co-ordinates x, y, z . Let there be N of them per unit of volume, moving with velocities $dx/dt, dy/dt, dz/dt$, which, after adding to them as a fourth

quantity dt/dt , we shall for symmetry denote by $w^{(1)}, w^{(2)}, w^{(3)}, w^{(4)}$, respectively. In the same way we shall often for convenience sake write $x^{(1)}, x^{(2)}, x^{(3)}, x^{(4)}$, for x, y, z, t . The components $w^{(a)}$ are assumed to be continuous functions of the co-ordinates and the time.

The stream-components are seen to be $Nw^{(1)}, Nw^{(2)}$, and $Nw^{(3)}$, to which we add a fourth $Nw^{(4)}=N$. They will be altered when the particles suffer displacements as defined in the following.

We take θ as a variational parameter and suppose a quaternary vector given with components $r^{(1)}, r^{(2)}, r^{(3)}, r^{(4)}$. If the parameter increases by $d\theta$, the particles shall shift from the positions (x, y, z) occupied by them at the instant t to the positions

$$x + r^{(1)}d\theta, \quad y + r^{(2)}d\theta, \quad z + r^{(3)}d\theta,$$

to be occupied at the instants

$$t + r^{(4)}d\theta.$$

The components $r^{(1)}, r^{(2)}, r^{(3)}, r^{(4)}$ are assumed to be continuous functions of the co-ordinates and time. For each particle the values of r^a must be taken which are actually found in the place and at the instant from where the infinitesimal shift begins.

It will be seen that the total displacements and shift in time of the particles from the point-instants of their undisturbed motions ($\theta=0$) will be

$$r^{(1)}\theta, \quad r^{(2)}\theta, \quad r^{(3)}\theta, \quad r^{(4)}\theta,$$

in a first approximation, and, taking account of terms with θ^2 in a second approximation :

$$\begin{aligned} \Delta x^a &= \int_0^\theta d\vartheta \left(r^a + \sum(c) \frac{\partial r^a}{\partial x^c} r^c \vartheta \right), \\ &= r^a \theta + \frac{1}{2} \sum(c) \frac{\partial r^a}{\partial x^c} r^c \theta^2, \quad (a=1, 2, 3, 4) \quad . \quad (1) \end{aligned}$$

where r^a and $\partial r^a / \partial x^c$ have values corresponding to the point-instants of the undisturbed motion. In this and subsequent formulæ the summations are to be extended over all values from 1 to 4 of the index put in brackets.

In consequence of these displacements the stream-components will change to

$$Nw^a + \delta Nw^a + \frac{1}{2} \delta^2 Nw^a + \dots$$

It will now be our business to find the first variation $\delta N w^a$ and the second variation $\delta^2 N w^a$.

§ 3. *The first variation of the stream.*

The following conception of the stream-components will greatly facilitate the evaluation of the variation. We keep our eyes on the content of a space-element dV , situated at the point $x^{(1)}, x^{(2)}, x^{(3)}$, at the time $x^{(4)}$. Though physically infinitesimal the element is supposed to contain a great many particles so that NdV is a great number. In an interval dt these particles will in a four-dimensional space-time extension describe their so-called world-lines, that will fill up an infinitesimal extension $dVdt$. Now sum up the components of these lines in the direction of X^a , say. We find obviously $NdV dx^a$. Dividing by the four-dimensional extension $dV dt$ we can say that *the stream-component in the direction of X^a is the sum of the components described by the individual particles per unit of volume per unit of time* :

$$\frac{NdV dx^a}{dV dt} = Nw^a.$$

We hardly need say that the fourth component represents the number of particles per unit of volume. It is obvious that these components will satisfy the condition of continuity:

$$\Sigma(b) \frac{\partial Nw^b}{\partial x^b} = 0. (2)$$

By the displacements the component of each individual world-line will change to

$$dx^a + \Sigma(b) \theta \frac{\partial x^a}{\partial x^b} dx^b,$$

if we neglect θ^2 .

The sum of the components will thus grow to

$$NdV \left\{ dx^a + \Sigma(b) \theta \frac{\partial x^a}{\partial x^b} dx^b \right\}.$$

On the other hand we must be aware that the extension occupied by the world-lines has changed also. We can find the increase with the aid of the functional determinant of the

$x^a + \Delta x^a$ with respect to x^a :

$$(dV dt)' = \begin{vmatrix} \frac{\partial(x^a + \Delta x^a)}{\partial x^a} & \frac{\partial(x^a + \Delta x^a)}{\partial x^b} & \cdot & \cdot \\ \frac{\partial(x^b + \Delta x^b)}{\partial x^a} & \frac{\partial(x^b + \Delta x^b)}{\partial x^b} & \cdot & \cdot \\ \cdot & \cdot & \cdot & \cdot \\ \cdot & \cdot & \cdot & \cdot \end{vmatrix} dV dt,$$

or, consistently neglecting θ^2 :

$$= \begin{vmatrix} 1 + \theta \frac{\partial r^a}{\partial x^a} & \theta \frac{\partial r^a}{\partial x^b} & \cdot & \cdot \\ \theta \frac{\partial r^b}{\partial x^a} & 1 + \theta \frac{\partial r^b}{\partial x^b} & \cdot & \cdot \\ \cdot & \cdot & \cdot & \cdot \\ \cdot & \cdot & \cdot & \cdot \end{vmatrix} dV dt,$$

$$= \left[1 + \Sigma(b) \theta \frac{\partial r^b}{\partial x^b} \right] dV dt.$$

Thus we find after the displacement the sum of the individual components described per unit of volume per unit of time to be :

$$Nw^a + \Delta Nw^a = \left[Nw^a + \Sigma(b) Nw^b \theta \frac{\partial r^a}{\partial x^b} \right] \cdot \left[1 - \Sigma(b) \theta \frac{\partial r^b}{\partial x^b} \right],$$

$$= Nw^a + \Sigma(b) \theta \left\{ Nw^b \frac{\partial r^a}{\partial x^b} - Nw^a \frac{\partial r^b}{\partial x^b} \right\}.$$

Now it must be borne in mind that this value of the new stream-component is found in the point-instant $x^a + \Delta x^a$ and not in the point-instant x^a , where we wanted to know it. To obtain the latter value we obviously ought to choose our starting-point in the point-instant $x^a - \theta r^a$, and take

$$Nw^a - \Sigma(b) \frac{\partial Nw^a}{\partial x^b} \theta r^b$$

instead of Nw^a . Thus we find, availing ourselves of the equation of continuity (2) also :

$$Nw^a + \delta Nw^a = Nw^a + \Sigma(b) \theta \frac{\partial}{\partial x^b} \left\{ r^a Nw^b - r^b Nw^a \right\},$$

and the first variation is

$$\delta Nw^a = \Sigma(b) \theta \frac{\partial}{\partial x^b} \left\{ r^a Nw^b - r^b Nw^a \right\} \dots (3)$$

§ 4. *The second variation.*

The second variation may be found without calculation by a formal process. Indeed, we only have to substitute $\delta N w^a$ for $N w^a$ in formula (3) which gives $\delta N w^a$ to get :

$$\begin{aligned} \delta \delta N w^a &= \Sigma(b) \theta \frac{\partial}{\partial x^b} \left[r^a \delta N w^b - r^b \delta N w^a \right], \\ \delta^2 N w^a &= \Sigma(bc) \theta^2 \frac{\partial}{\partial x^b} \left[r^a \frac{\partial}{\partial x^c} \left\{ r^b N w^c - r^c N w^b \right\} \right. \\ &\quad \left. - r^b \frac{\partial}{\partial x^c} \left\{ r^a N w^c - r^c N w^a \right\} \right]. \quad (4) \end{aligned}$$

It is, however, very important to state that this formula for the second variation implies the definition of the displacements with an accuracy up to terms with θ^2 as given in formula (1). This can be verified by a direct calculation following throughout the same line of argument as in the preceding section, taking account of the terms of second order everywhere. We shall not give the calculation at full length, we may restrict ourselves to the indication that at the last step, viz., in choosing the right starting-point from where the displacement will carry us to the point-instant x^a under consideration, we have to be careful to take

$$x^a - \theta r^a + \frac{1}{2} \theta^2 \Sigma(c) \frac{\partial r^a}{\partial x^c} r^c,$$

and not $x^a - \Delta x^a$, as might be thought erroneously at first sight.

§ 5. *The simultaneous displacements.*

As yet the displacements considered have been accompanied by a shift in time. In view of the physical interpretation of the formulæ obtained, it will however be necessary to realise the simultaneous positions of the electrons relative to their nuclei.

There is no objection to simplifying our formulæ by dropping θ henceforth. Now, in a first approximation, we find the electron belonging to the nucleus, which at the instant $x^{(4)}$ is in the point $x^{(1)}$, $x^{(2)}$, $x^{(3)}$, shifted to the point

$$x^{(1)} + r^{(1)}, \quad x^{(2)} + r^{(2)}, \quad x^{(3)} + r^{(3)},$$

at the instant

$$x^{(4)} + r^{(4)}.$$

Thus we see that its position at the time $x^{(4)}$ will be given by

$$x^{(1)} + \rho^{(1)}, \quad x^{(2)} + \rho^{(2)}, \quad x^{(3)} + \rho^{(3)},$$

where

$$\rho^a = r^a - w^a r^{(4)}. \quad \dots \quad (5)$$

For an obvious reason $\rho^{(4)} = 0$.

Next, to obtain the second approximation, consider the nucleus at the instant

$$x^{(4)} - r^{(4)} - \frac{1}{2} \Sigma(c) \left\{ \frac{\partial r^{(4)}}{\partial x^c} r^c - 2 \frac{\partial r^{(4)}}{\partial x^c} w^c r^{(4)} \right\},$$

when its co-ordinates are

$$x^a - w^a r^{(4)} - \frac{1}{2} w^a \Sigma(c) \left\{ \frac{\partial r^{(4)}}{\partial x^c} r^c - 2 \frac{\partial r^{(4)}}{\partial x^c} w^c r^{(4)} \right\} + \frac{1}{2} \frac{dw^a}{dt} r^{(4)} r^{(4)}.$$

This line implies the preceding as a special case, for $a=4$.

Then the displacements of the electron will be

$$r^a + \frac{1}{2} \Sigma(c) \frac{\partial r^a}{\partial x^c} r^c - \Sigma(c) \frac{\partial r^a}{\partial x^c} w^c r^{(4)},$$

so that its position will be given by

$$x^a + r^a - w^a r^{(4)} + \frac{1}{2} \frac{dw^a}{dt} r^{(4)} r^{(4)} + \Sigma(c) \left[\frac{1}{2} r^c \left(\frac{\partial r^a}{\partial x^c} - w^a \frac{\partial r^{(4)}}{\partial x^c} \right) - r^{(4)} w^c \left(\frac{\partial r^a}{\partial x^c} - w^a \frac{\partial r^{(4)}}{\partial x^c} \right) \right].$$

Taking $a=4$ it is easily seen that this formula yields the positions just at the instant $x^{(4)}$, *i. e.*, the simultaneous positions and displacements; for $w^{(4)}=1$ is a constant, and all terms vanish except the first.

We can simplify the formula considerably. Writing

$$\Sigma(c) w^c \frac{\partial}{\partial x^c} = \frac{d}{dt},$$

and introducing a notation well known in three-dimensional vector-analysis :

$$\Sigma(c) \rho^c \frac{\partial}{\partial x^c} = (\rho \cdot \nabla),$$

our expression reduces to

$$x^a + \rho^a + \frac{1}{2} (\rho \cdot \nabla) \rho^a - \frac{1}{2} r^{(4)} \left\{ \frac{d\rho^a}{dt} - (\rho \cdot \nabla) w^a \right\},$$

and the simultaneous displacements are

$$\rho^a + \frac{1}{2} (\rho \cdot \nabla) \rho^a - \frac{1}{2} r^{(4)} \left\{ \frac{d\rho^a}{dt} - (\rho \cdot \nabla) w^a \right\} \dots (a=1, 2, 3). \quad (6)$$

§ 6. *The interpretation of the first variation.*

If the negative charge of an electron, the elementary charge, be denoted by e , the current carried by the stream of the positive nuclei will have the components

$$-eNw^a,$$

and the stream of accompanying electrons will carry a current

$$eNw^a + e\delta Nw^a + \frac{1}{2}e\delta^2 Nw^a,$$

the resultant current from the charges bound in the neutral atoms amounting to

$$e\delta Nw^a + \frac{1}{2}e\delta^2 Nw^a.$$

Now let us consider the first part, originating from the first variation. It contains what was formerly called the contribution from the polarization-electrons. We know by formula (3) that

$$e\delta Nw^a = \Sigma(b) \frac{\partial}{\partial x^b} \left\{ er^a Nw^b - er^b Nw^a \right\}.$$

We shall consider the tensor :

$$P^{ab} = er^a Nw^b - er^b Nw^a.$$

This is the same as

$$= N e \rho^a w^b - N e \rho^b w^a,$$

} (7)

where ρ^a is the principal term in the expression (6) giving the simultaneous displacements. Introducing for the principal part of the polarization the three-dimensional vector

$$p_a = N e \rho^a,$$

we recognize in the (14)-, (24)-, (34)-components of the tensor P^{ab} components of polarization, and in the (12)-, (23)-, (31)-components the components of the well-known Röntgen-vector which is the three-dimensional vector-product of the material velocity \mathbf{w} into the polarization. Collecting the components of P^{ab} in the scheme

$$P^{ab}(=) \begin{array}{cccc} & & [\mathbf{p} \cdot \mathbf{w}]_z & -[\mathbf{p} \cdot \mathbf{w}]_y & p_x \\ -[\mathbf{p} \cdot \mathbf{w}]_z & & & [\mathbf{p} \cdot \mathbf{w}]_x & p_y \\ [\mathbf{p} \cdot \mathbf{w}]_y & -[\mathbf{p} \cdot \mathbf{w}]_x & & & p_z \\ -p_x & -p_y & & -p_z & \end{array},$$

one may see at a glance that the first three of the components of the variation $e\delta N w^a$ are the components of

$$\text{rot}[\mathbf{p} \cdot \mathbf{w}] + \dot{\mathbf{p}}, \quad \dots \dots \dots (8 a)$$

and that the fourth becomes

$$-\text{div } \mathbf{p} \quad \dots \dots \dots (8 b)$$

The first variation thus furnishes a polarization-current $\dot{\mathbf{p}}$ and the corresponding Röntgen-current $\text{rot}[\mathbf{p} \cdot \mathbf{w}]$; besides it shows a polarization-charge.

§ 7. The interpretation of the second variation.

The second variation too is connected by a differential operator to a tensor, M^{ab} :

$$\frac{1}{2}e\delta^2 N w^a = \Sigma(b) \frac{\partial M^{ab}}{\partial x^b},$$

where

$$M^{ab} = \frac{1}{2}(e r^a \delta N w^b - e r^b \delta N w^a).$$

We divide this into two parts:

$$M^{ab} = \frac{1}{2}e\delta N (r^a w^b - r^b w^a) + \frac{1}{2}eN (r^a \delta w^b - r^b \delta w^a),$$

the first of which is nothing but a correction to the polarization-tensor P^{ab} . We can put it into the form

$$\frac{1}{2}e\delta N (r^a w^b - r^b w^a) = \frac{1}{2}e\delta N (\rho^a w^b - \rho^b w^a),$$

and as in the preceding section we find contained in it a polarization

$$\frac{1}{2}e\delta N \rho^a,$$

and the corresponding Röntgen-vector. At a closer inspection, taking δN from (7) we see

$$\begin{aligned} \frac{1}{2}e\delta N \rho^a &= -\frac{1}{2}e\Sigma(c) \frac{\partial N \rho^c}{\partial x^c} \rho^a, \\ &= -\frac{1}{2}\Sigma(c) \frac{\partial (eN \rho^a \rho^c)}{\partial x^c} + \frac{1}{2}eN (\rho \cdot \nabla) \rho^a. \end{aligned}$$

The latter part is in good agreement with a term of the exact expression (6) for the displacements. The former part implies a correction that is grasped in its meaning as follows. Imagine that we want to know the polarization and that we therefore choose an arbitrary closed surface, taking the sum of the electric momenta of the atoms within and dividing by the volume. Then our correction amounts to saying that an atom will be reckoned to lie within the surface only when the centre halfway between nucleus and electron lies within.

Turning to the second part of M^{ab} we require the value of δw^a . This we get from the known values of $\delta N w^a$ and $\delta N = \delta N w^{(4)}$ (form. (7)). It turns out to be

$$\delta w^a = \frac{d\rho^a}{dt} - \Sigma(c)\rho^c \frac{\partial \rho^a}{\partial x^c}.$$

Now write down

$$\begin{aligned} \frac{1}{2}eN(r^a\delta w^b - r^b\delta w^a) &= \frac{1}{2}eN(\rho^a\delta w^b - \rho^b\delta w^a) \\ &\quad - \frac{1}{2}eN(r^{(4)}\delta w^a \cdot w^b - r^{(4)}\delta w^b \cdot w^a), \end{aligned}$$

and we see that the latter part:

$$-\frac{1}{2}eN \left\{ r^{(4)} \left(\frac{d\rho^a}{dt} - (\rho \cdot \nabla) w^a \right) w^b - r^{(4)} \left(\frac{d\rho^b}{dt} - (\rho \cdot \nabla) w^b \right) w^a \right\},$$

gives a polarization again with the corresponding Röntgen-vector.

This last correction,

$$-\frac{1}{2}eNr^{(4)} \left\{ \frac{d\rho^a}{dt} - (\rho \cdot \nabla) w^a \right\},$$

brings the polarization into complete agreement with the value given in (6) for the electrons' exact displacements.

These second-order polarization corrections are very intimately connected with the magnetization, and always come into play whenever magnetized matter is moving. This is well known.

It remains to investigate the nature of the part

$$\frac{1}{2}eN(\rho^a\delta w^b - \rho^b\delta w^a).$$

If we write

$$\begin{aligned} \frac{1}{2}eN(\rho^a\delta w^b - \rho^b\delta w^a) &= \frac{1}{2}eN \left(\rho^a \frac{d\rho^b}{dt} - \rho^b \frac{d\rho^a}{dt} \right) \\ &\quad - \frac{1}{2}\Sigma(c)eN \left(\rho^a \rho^c \frac{\partial w^b}{\partial x^c} - \rho^b \rho^c \frac{\partial w^a}{\partial x^c} \right), \end{aligned}$$

we notice that both expressions vanish for a value 4 of one of the index-numbers a or b . We recognize that

$$\frac{1}{2c}e \left(\rho^a \frac{d\rho^b}{dt} - \rho^b \frac{d\rho^a}{dt} \right)$$

are the components of the magnetic momentum of an atom. Thus, writing m_x, m_y, m_z for the magnetization we evidently have

$$cm_z = \frac{1}{2}eN \left(\rho^r \frac{d\rho^y}{dt} - \rho^y \frac{d\rho^r}{dt} \right), \quad \text{a. s. o.}$$

In the second expression appear the quantities

$$\frac{1}{2}e\rho^a\rho^c,$$

being the quadratic electric momenta of the atoms. These quantities figure in recent investigations of Debye and Holtzmark on the broadening of spectral lines of luminous gases under increased pressure*. They seem to afford a measure for the electrical extension of the atoms, and so it is proposed to call their sum per unit of volume (provisionally) the *electric extension* :

$$K^{ac} = \frac{1}{2}eN\rho^a\rho^c.$$

In a form of three-dimensional vector-analysis we can contract the three components under discussion into a vector

$$\mathbf{k} = - [({}^2\mathbf{K} \cdot \nabla) \cdot \mathbf{w}],$$

where the number 2 added to the left of ${}^2\mathbf{K}$ has to remind us that ${}^2\mathbf{K}$ is a symmetrical tensor and therefore $({}^2\mathbf{K} \cdot \nabla)$ is a differential operator with vector-properties †.

This vector \mathbf{k} is analogous to the Röntgen-vector. It accounts in its curl for the second order influence of the motion of polarized matter on the electric current.

Gathering the various corrections of the polarization into a single vector \mathbf{n} , we can collect the *result of the second variation* into the scheme for our tensor M^{ab} :

$$M^{ab}(=) \begin{array}{ccc} cm_z + k_z + [\mathbf{n} \cdot \mathbf{w}]_z & -cm_y - k_y - [\mathbf{n} \cdot \mathbf{w}]_y & n_x \\ -cm_z - k_z - [\mathbf{n} \cdot \mathbf{w}]_z & cm_x + k_x + [\mathbf{n} \cdot \mathbf{w}]_x & n_y \\ cm_y + k_y + [\mathbf{n} \cdot \mathbf{w}]_y & -cm_x - k_x - [\mathbf{n} \cdot \mathbf{w}]_x & n_z \\ -n_x & -n_y & -n_z \end{array}$$

whence we get by the formula

$$\frac{1}{2}e\delta^2 N w^a = \Sigma(b) \frac{\partial M^{ab}}{\partial x^b},$$

a current :

$$e \operatorname{rot} \mathbf{m} + \operatorname{rot} \mathbf{k} + \operatorname{rot} [\mathbf{n} \cdot \mathbf{w}] + \dot{\mathbf{n}}, \quad \dots \quad (9 a)$$

and a charge :

$$-\operatorname{div} \mathbf{n}. \quad \dots \quad (9 b)$$

We notice a *polarization-current* $\dot{\mathbf{n}}$, the *Röntgen-current*

* Debye, *Phys. Zschr.* xx. p. 160; Holtzmark, *ibidem*, p. 162 (1919).

† Cf. the notation of Prof. J. A. Schouten in "Die directe Analysis zur neueren Relativitätstheorie," *Transactions Kon. Akad. v. Wetenschappen, Amsterdam*, xii. No. 6, 1919.

corresponding to the complementary polarization \mathbf{n} , and the well-known magnetization-current $c \text{ rot } \mathbf{m}$. As stated above the current

$$\text{rot } \mathbf{k}$$

originates from a second order influence of the motion of polarized matter. It is neglected because of its smallness in the deductions of Lorentz and of Cunningham*. In the paper of Born cited above it is not separated from the magnetization-current. Perhaps its action might be detected experimentally if a rotating sphere of insulating material were surrounded by a fixed circuit about its equator and placed in a strong homogeneous electric field with the lines of force parallel to the equator's plane. An oscillating rotation of the sphere should induce an oscillating current in the circuit.

§ 8. Remarks concerning Covariancy.

In the introduction allusion was made to the covariancy of the result of the variation. Indeed, a reader familiar with Einstein's theory of general relativity may easily convince himself that equations (3) and (4) are invariant in the general sense. From the definition of Nw^a in § 3 it is clear that Nw^a is $\sqrt{g} \times$ a contravariant vector, where \sqrt{g} is the well-known factor in that theory; for in the numerator NdV is a definite scalar number and dx^a a contravariant vector, in the denominator $\sqrt{g}dVdt$ would have been a scalar.

Nw^a being $\sqrt{g} \times$ a contravariant vector, we see that

$$r^a Nw^b - r^b Nw^a$$

is $\sqrt{g} \times$ a contravariant anti-symmetrical tensor, and δNw^a :

$$\delta Nw^a = \Sigma(b) \frac{\partial}{\partial x^b} (r^a Nw^b - r^b Nw^a)$$

is seen to be $\sqrt{g} \times$ the contravariant vector-divergency of the tensor and therefore $\sqrt{g} \times$ a contravariant vector itself.

The same may be said, *mutatis mutandis*, of the second variation $\delta^2 Nw^a$.

Knowing the character of P^{ab} and M^{ab} as $\sqrt{g} \times$ contravariant tensors, it is easy to deduce the ordinary transformation-formulæ for the polarization and the magnetization. This, however, will not be done here.

* Lorentz, *Enc. d. Math. Wiss.*; Cunningham, 'Principle of Relativity.'

XL. *An Elementary Theory of the Scattering of Light by Small Dielectric Spheres.* By JAKOB KUNZ*.

THIS problem was solved a long time ago by Lord Rayleigh †, who used spherical harmonics. In the present analysis it will be shown that the same fundamental result can be obtained by elementary considerations without

Fig. 1.

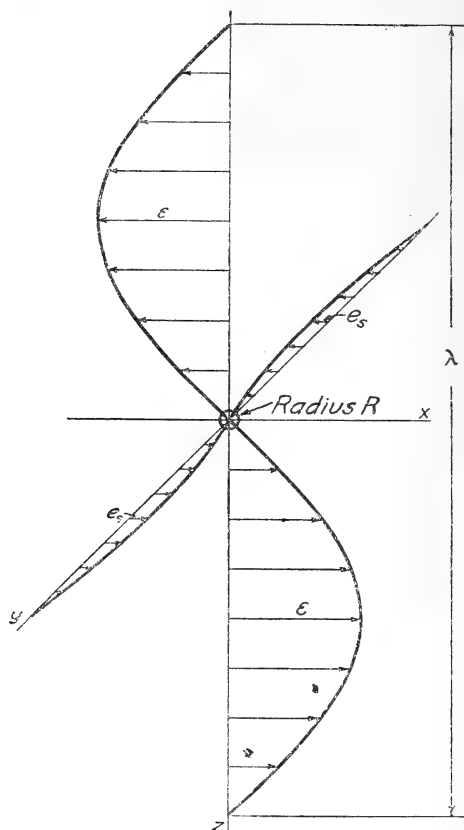

the use of spherical harmonics. We consider a plane polarized beam of light, proceeding from above in a vertical direction, Z , so that the plane of polarization is perpendicular to the

* Communicated by the Author.

† Scientific Papers of Lord Rayleigh, vol. i. p. 87; vol. iv. p. 397.

plane of fig. 1, which contains therefore the electric force, E , oscillating in the x direction. In the path of this beam of light is placed a sphere of dielectric constant k and of radius R small compared with the wave-length λ . In each moment we may consider the sphere as surrounded by a uniform electric field, E . Now, if a dielectric sphere is placed in a uniform field, there will be induced in the sphere a uniform field also, and the original field outside the sphere will be disturbed as if the sphere were replaced by a doublet of moment

$$\mu = E \frac{k-1}{k+2} R^3 = ql,$$

where q represents the charge in one pole and l the distance between the two poles of the doublet. If the field is alternating according to the equation $e = E \sin 2\pi nt$, the doublet will oscillate according to :

$$\mu = E \frac{k-1}{k+2} R^3 \sin 2\pi nt$$

or $\mu = ql \sin 2\pi nt$

and $\frac{d^2\mu}{dt^2} = -(2\pi n)^2 E \frac{k-1}{k+2} R^3 \sin 2\pi nt. \dots (1)$

If the doublet oscillates it will emit electric waves which have been studied by H. Hertz. In the neighbourhood of the doublet the oscillations are fairly complicated, but at large distances we find simple spherical waves, in which the electric and magnetic forces can be studied by the pulse method as follows :—

The variable moment μ is either equal to

$$\mu = ql \sin 2\pi nt = qx$$

or equal to $\mu = q \sin 2\pi nt \cdot l = q_v \cdot l.$

In the latter case the charge is considered variable, and the length l constant; in the former case the charge q is considered constant while oscillating in simple harmonic motion through an interval $2l$. This corresponds to the oscillation of a charge around a centre of attraction, and we have

$$\frac{d\mu}{dt} = q \frac{dx}{dt}; \quad \frac{d^2\mu}{dt^2} = q \frac{d^2x}{dt^2} = q \cdot f, \dots (2)$$

where f is the acceleration.

Now, if a charge having a velocity v is abruptly brought to rest at O , of fig. 2, a spherical pulse of strong electric and magnetic forces will spread out with the velocity of light c .

Fig. 2.

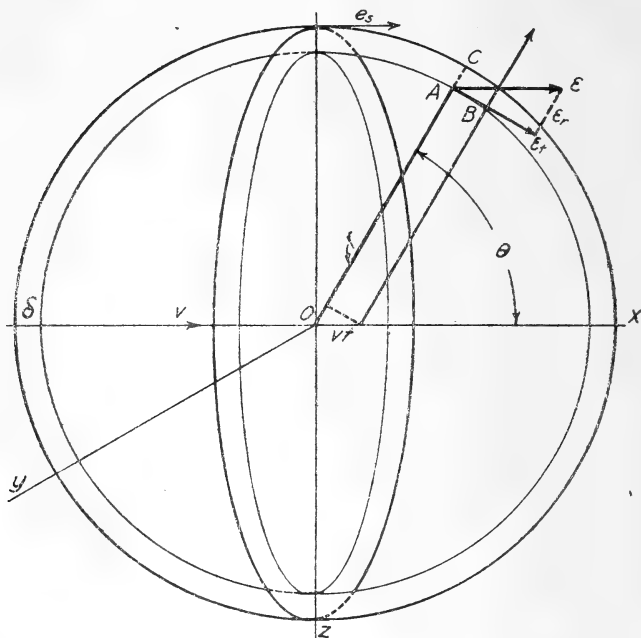

The ratio of the two components $\frac{E_t}{E_r}$ of the electric force E in the pulse will be equal to

$$\frac{E_t}{E_r} = \frac{AB}{AC} = \frac{vt \sin \vartheta}{\delta}; \quad E_r = \frac{q'}{r^2};$$

$$E_t = \frac{qvt \sin \vartheta}{ctr\delta} \quad \text{because } r = ct,$$

or $E_t = \frac{qv \sin \vartheta}{cr\delta}$ and the magnetic force $H = cE_t = \frac{qv \sin \vartheta}{r\delta}$

is vertical on the plane of the last figure in the point A . Now let the decrease of the velocity of the charge q be Δv during Δt seconds, then we have $\delta = c\Delta t$ and

$$E_t = \frac{\Delta v q \sin \vartheta}{c\delta r} = \frac{\Delta v}{\Delta t} \frac{q \sin \vartheta}{c^2 r}.$$

In the limit $\frac{dv}{dt} = -f$, we find

$$E_t = -\frac{fq \sin \vartheta}{c^2 r}, \dots \dots \dots (3)$$

or by (2)
$$E_t = -\frac{d^2 \mu \sin \vartheta}{dt^2 c^2 r},$$

or by (1)
$$E_t = E \frac{k-1}{k+2} R^3 \frac{\sin \vartheta}{r} \sin 2\pi n t \frac{4\pi^2 n^2}{c^2}.$$

But $\lambda n = c$, hence

$$E_t = E \frac{k-1}{k+2} R^3 \frac{4\pi^2 \sin \vartheta}{\lambda^2 r} \sin 2\pi n t,$$

or, if we write e_s for E_t the secondary wave can be represented by

$$e_s = E \frac{k-1}{k+2} R^3 \frac{4\pi^2 \sin \vartheta}{\lambda^2 r} \sin 2\pi n(t-t'),$$

where $t' = \frac{r}{c}$, $n = \frac{c}{\lambda}$,

$$e_s = E \frac{k-1}{k+2} R^3 \frac{4\pi^2 \sin \vartheta}{\lambda^2 r} \sin \frac{2\pi}{\lambda}(ct-r) \dots \dots (4)$$

or
$$e_s = E_s \sin \frac{2\pi}{\lambda}(ct-r),$$

where
$$E_s = E \frac{k-1}{k+2} R^3 \frac{4\pi^2 \sin \vartheta}{\lambda^2 r},$$

while the primary wave is represented by

$$e = E \sin \frac{2\pi}{\lambda}(ct-z) \dots \dots \dots (5)$$

For $\vartheta=0$, the electric and magnetic forces vanish and no light is given out in the direction x of the oscillation of the doublet. For $\vartheta = \frac{\pi}{2}$, the electric and magnetic forces become a maximum on the surface of a sphere of radius r . No light is given out in the direction x , which is perpendicular to the original plane of polarization; the light emitted in the vertical plane yz is plane polarized; it is also polarized in every other direction so that the plane of polarization in every beam is perpendicular to e_s (see fig. 1).

The energy per unit volume and the intensity of the light

420 Prof. Jakob Kunz: *An Elementary Theory of the*
 scattered in any direction is proportional to E_s^2 and therefore
 proportional to $\sin^2 \vartheta$.

The energy dE contained in a ring of volume

$$d\tau = 2\pi r \sin \vartheta r d\vartheta \cdot 1$$

due to the oscillating doublet

$$\text{is equal to } dE = \frac{E_s^2}{8\pi} d\tau$$

$$\text{or equal to } dE = \frac{1}{8\pi} E^2 \left(\frac{k-1}{k+2}\right)^2 g V^2 \frac{\pi^2 \sin^2 \vartheta}{\lambda^4 r^2} 2\pi r^2 \sin \vartheta d\vartheta,$$

where $V = \frac{4\pi}{3} R^3$ is the volume of the scattering sphere.

The energy E_s in a spherical shell of unit thickness is therefore

$$\begin{aligned} E_s &= \frac{g\pi^2}{4} \frac{E^2 V^2}{\lambda^4} \left(\frac{k-1}{k+2}\right)^2 \cdot 2 \cdot \int_0^{\frac{\pi}{2}} \sin^3 \vartheta d\vartheta \\ &= 3\pi^2 \frac{E^2 V^2}{\lambda^4} \left(\frac{k-1}{k+2}\right)^2, \end{aligned}$$

but the electric energy E_1 per unit volume of the primary
 beam is equal to $E_1 = \frac{E^2}{8\pi}$, hence

$$E_s = 24\pi^3 E_1 \frac{V^2}{\lambda^4} \left(\frac{k-1}{k+2}\right)^2.$$

For the light scattered by N particles per unit volume,
 arranged in random order so that energies may be summed
 without considering phase differences, we should have

$$\frac{E_s}{E_1} = 24\pi^3 \frac{V^2}{\lambda^4} \left(\frac{k-1}{k+2}\right)^2 N, \quad \dots \quad (6)$$

an expression first given by Lord Rayleigh by a different
 method. The energy radiated from a layer of thickness dz
 and of unit area is therefore

$$-\frac{dE_1}{E_1} = 24\pi^3 \frac{V^2}{\lambda^4} \left(\frac{k-1}{k+2}\right)^2 N dz$$

or $E_1 = E_0 e^{-hz},$

where $h = 24\pi^3 \frac{V^2}{\lambda^4} \left(\frac{k-1}{k+2}\right)^2 N.$

If, however, we investigate the scattered light proceeding in the direction z of the original beam, we have to take into account the phases as well as the intensities of the electric forces. Let us consider a layer dz of equal particles, of

Fig. 3.

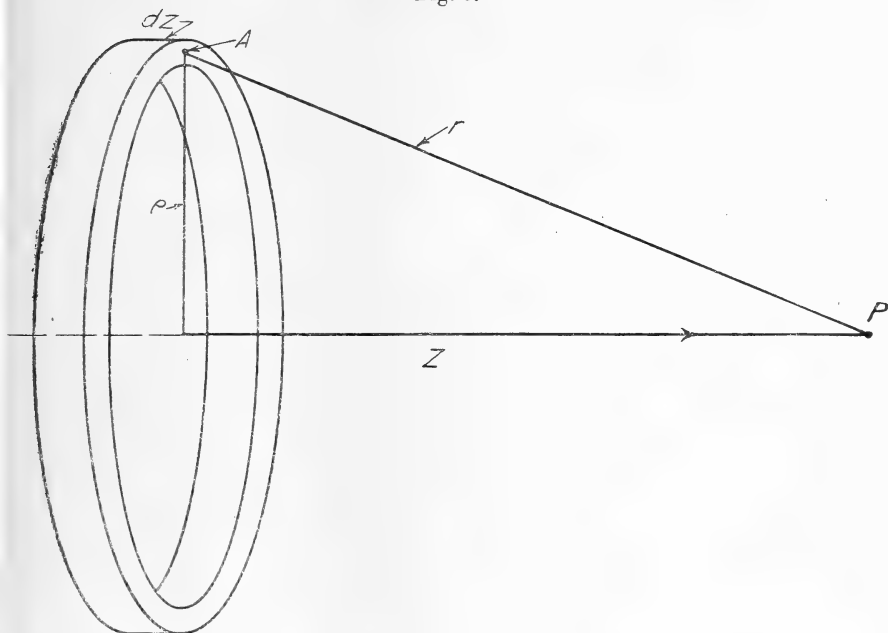

index of refraction γ , and calculate the resultant electric force e_s at any point P on the path of the original beam where $\sin \vartheta = 1$, due to all the doublets in the stratum. The volume of an infinitesimal ring will be (fig. 3)

$$d\tau = dz 2\pi \rho d\rho = dz 2\pi r dr$$

as $\rho^2 + z^2 = r^2$.

For $\sin \vartheta = 1$ and $E = 1$ we get from (4)

$$e_s = \frac{k-1}{k+2} \frac{3\pi V}{\lambda^2} \frac{1}{r} \sin \frac{2\pi}{\lambda} (ct-r).$$

The resultant electric force due to all particles in $d\tau$ is therefore

$$d(e_s)_r = N dz \frac{k-1}{k+2} \frac{3\pi V}{\lambda^2} \sin \frac{2\pi}{\lambda} (ct-r) \frac{2\pi r dr}{r},$$

and the resultant electric force due to the infinitesimal layer is equal to

$$(e_s)_r = N dz \frac{k-1}{k+2} \frac{3\pi V}{\lambda^2} \int_z^\infty \sin \frac{2\pi}{\lambda} (ct-r) dr \cdot 2\pi$$

or $(e_s)_r = -N dz \frac{k-1}{k+2} \frac{3\pi V}{\lambda} \cos \frac{2\pi}{\lambda} (ct-z),$

while that of the original beam is equal to

$$e_1 = 1 \cdot \sin \frac{2\pi}{\lambda} (ct-z)$$

and the sum is equal to

$$e = e_1 + (e_s)_r = \sin \frac{2\pi}{\lambda} (ct-z) - N dz \frac{k-1}{k+2} \frac{3\pi V}{\lambda} \cos \frac{2\pi}{\lambda} (ct-z) \quad \dots \quad (7)$$

or $e = \sin \frac{2\pi}{\lambda} (ct-z-\delta)$

or $e = \sin \frac{2\pi}{\lambda} (ct-z) - \cos \frac{2\pi}{\lambda} (ct-z) \frac{2\pi\delta}{\lambda}, \dots \dots \dots (8)$

because the path difference δ is a small quantity. Comparing (7) and (8) we obtain

$$\frac{2\pi\delta}{\lambda} = N dz \frac{k-1}{k+2} \frac{3\pi V}{\lambda}$$

or $\delta = N dz \frac{k-1}{k+2} \frac{3V}{2} \dots \dots \dots (9)$

On the other hand, Huygens' theory gives for the path difference

$$\delta = (\gamma-1) dz,$$

hence $\gamma-1 = N \frac{3V}{2} \frac{k-1}{k+2} \dots \dots \dots (10)$

or $V^2 N^2 \left(\frac{k-1}{k+2}\right)^2 = (\gamma-1)^2 \frac{4}{9}.$

If we substitute this expression in (6) and assume $E_1=1$ we obtain

$$E_s = \frac{32}{3} \frac{\pi^3 (\gamma-1)^2}{\lambda^4 N},$$

an important relation first established by Rayleigh.

XLI. *Light Scattering by Air and the Blue Colour of the Sky.*
 By R. W. WOOD, *For. Mem. R.S., Professor of Experimental
 Physics, Johns Hopkins University**.

THE scattering of light by dust-free air was first observed by Cabannes (*Comptes Rendus*, clx. p. 62), who focussed the image of a quartz-mercury arc at the centre of a dark box lined with black velvet, viewing the scattered radiation through a glass window in the wall of the box on a line formed by the prolongation of the image of the arc. Strutt, working independently and without knowledge of the investigation of Cabannes, observed the same phenomenon and made a very comprehensive study of the relative scattering power of different gases, its dependence upon the density of the gas and its state of polarization (*Proc. Roy. Soc.* vol. xciv. p. 453, vol. xc. p. 155, 1918).

The results of certain investigations of atmospheric transmission appear to justify Lord Rayleigh's theory that the blue sky is completely accounted for by the scattering of the air molecules themselves, independently of the presence of any foreign matter.

So far as I am aware, however, no attempts have been made, up to the present time, to compare the scattering exhibited by dust-free air in a tube with the direct light of the sky (as to intensity), or to compare the scattering power of the air near the surface of the earth on a very clear day with the average scattering power of the whole atmosphere.

Abbot's work on the absorption of light by the atmosphere showed that the loss of intensity due to passage through the lower mile of air above Washington was practically equal to the total loss resulting from passage through the entire atmosphere above the first mile (roughly four miles of homogeneous atmosphere). This indicates that its scattering power is considerably greater than that of the higher atmosphere, where the foreign matter is present in much smaller quantities. There would doubtless be less foreign matter in country locations.

The present paper deals with the scattering power of the air close to the ground, and the photometric comparison of the intensity of the light scattered by dust-free air, when illuminated by a concentrated beam of sunlight, with the intensity of the blue sky on a very clear day.

We will commence with the second subject.

The air was contained in a tube of black fibre 10 cm. in

* Communicated by the Author.

diameter and 70 cm. long, provided with two lateral tubes of brass furnished with glass windows for the entrance and exit of the concentrated solar beam. The further end of the tube was lined with black velvet, which is far superior to a smoked surface. The observation window was carried on a brass tube 2 cm. in diameter and 15 cm. long, which was soldered into a hole which perforated the end plate of the tube. This was to shield the observation window as completely as possible from light reflected from the edges of the lateral tubes. The tube was filled with air filtered through cotton, and a beam of sunlight reflected from a silvered glass mirror focussed at the centre of the tube by means of a double convex reading-glass 15 cm. in diameter. The scattered beam was easily visible, even in a well-lighted room; it was bluish in colour, and was practically extinguished by a nicol properly oriented. No motes were visible. The diameter of the solar image formed by the lens was 4 mm., which gives us an area ratio of image to lens of $1/1400$, *i. e.* we have a layer of air 4 mm. in thickness, illuminated by a beam of sunlight 1400 times as intense as normal sunlight at the earth's surface. This is to be compared with the intensity of the blue sky near the zenith, considered as due to the illumination of five miles of homogeneous atmosphere by normal sunlight. It is to be remembered that the entire atmosphere if brought to normal pressure would form a layer five miles in depth.

As the sun was at 60° from the zenith at the time of the experiment, I chose a point 30° beyond the zenith for observation, in order to work with the rays scattered in a direction perpendicular to the sunlight.

A small flake of silvered plate glass with a razor edge was mounted in front of, and close to, the observation window. This reflected to the eye the light from the selected part of the sky, which was reflected from a large silvered mirror placed in the shade just below the mirror which reflected the sunlight to the condensing lens which illuminated the tube.

A rotating disk of black cardboard 35 cm. in diameter, mounted on the shaft of a motor, and furnished with a very narrow radial slit near its rim, was mounted close to the glass slider. By means of this the intensity of the sky light could be reduced by narrowing the slit until it matched the intensity of the scattered light in the tube. If the glass slider is viewed from a suitable distance its razor edge is seen in focus projected against the cone of scattered light in the tube, the edge disappearing when the match is secured. This occurred with a slit 0.2 mm. in width. The reduction in the intensity of the sky light is given by the ratio of the slit

width to the circumference through which it moves, in this case $1/4867$.

As we now know from Strutt's experiments, the light scattered by dust-free air is almost completely polarized. The light of the sky exhibits, however, not much over 60 per cent. of polarization in a direction perpendicular to the exciting rays. It seems reasonable to infer from this that about 40 per cent. of its light is due to secondary scattering (scattering of light coming from the rest of the sky and the earth together with a certain amount scattered by the larger particles forming the haze found at lower levels). This means that the sky as observed in the experiment had an intensity about 1.7 times as great as would be shown by a column of air five miles in depth illuminated only by the rays of the sun, and viewed end-on, which is really what is to be compared with the tube illumination. We have therefore effected a reduction of intensity with the rotating disk 1.7 times as great as would have been required if the conditions were as just specified.

Applying this correction alters our ratio of $1/4867$ to $1/2860$. This is to be compared with the ratio calculated for the 4 mm. of air illuminated in the tube and the five miles of air forming the sky. Sunlight at sea-level according to Abbot's tables has a value for the blue-green portion of the spectrum of about 50 per cent. of its value in space, when the sun is at a distance of 60° from the zenith. This has been increased 1400 times by the lens, and we can therefore represent the scattered illumination in the tube (on an arbitrary scale), if we call the intensity of sunlight in space unity, by $1400 \times 4 \times 1/2 = 2800$.

We must now compute the scattered intensity which we should expect from the atmosphere on the same arbitrary scale. Since we are observing a point 30° from the zenith, the effective depth through which we are observing is about 1.2 times the zenith depth, or six miles of homogeneous atmosphere. If we consider the sky as due to the illumination of this depth of air by sunlight of its full intensity in space (unity), the illumination will be represented by the number of millimetres in six miles, or 9,600,000, while our tube illumination was 2800.

The ratio of these two calculated numbers is $1/3430$, while the corrected ratio measured with the photometer was $1/2860$.

The agreement is remarkably good considering the enormous difference between the two intensities compared experimentally, and the uncertainty about just what values

to take in the calculations. For example, the six miles of air are considered as illuminated by sunlight of the full intensity which it has in space. The light loses intensity as it penetrates the air, and is reduced to about one half of its value when it reaches sea-level. On the other hand, the scattering power of the lower atmosphere appears to be abnormally high, due to the presence of foreign matter, and there is in addition secondary scattering; there is as well probably some true absorption in the lower air. These effects compensate to a certain extent, and on this account it seemed best to consider the full intensity of the sunlight available for the production of scattering, in the case of the sky.

It would be far better to make the experiment on the top of a high mountain, or even at one of the mountain observatories, and with the data given as to the dimensions and disposition of apparatus, the whole thing could be done in a day or two. The easiest way to make the slit on the disk is to paste two strips of very thin black paper on a microscope cover-glass and then paste the whole over a larger slit cut in the pasteboard disk. When the proper width has been found the cover can be detached and the slit width measured with the microscope. This was the method adopted in my summer laboratory with very limited facilities. An adjustable slit would be more convenient of course.

The colour match was very perfect, which alone indicates that the light of the blue sky comes chiefly from the air molecules; for, as will appear presently, the light scattered by the foreign matter in the lower atmosphere is yellowish in comparison with the colour of the clear sky.

It is perhaps open to question whether we are justified even in considering the sky illumination as represented by the number of molecules in the line of sight (or in other words, the thickness of the homogeneous atmosphere) multiplied by the intensity of the illumination.

The relation holds undoubtedly for small thicknesses of dust-free air, but Abbot's observations indicate that it does not hold at all for the distances concerned in producing the sky light.

For example, he finds that with the sun at an altitude of 46° , the sky 3° above the horizon is less than double the brightness of the sky at 57° , though the mass of air under observation in the line of sight for the sky near the horizon is thirteen times greater than in the case of the sky at an altitude of 57° . He shows conclusively that the intensity of the scattered light increases rather slowly in comparison with the increase in the number of the scattering molecules.

In this case his value found at 57° was at a point of the sky only 10° away from the sun, and is undoubtedly somewhat too large, as the sky in the vicinity of the sun shows an excess brightness due, as we shall see presently, to diffraction by foreign matter. I have a record of one measurement made by Mr. Nietz with an illuminometer from an air-plane at 3000 feet, which gave the zenith sky an intensity of half that of the horizon sky.

Molecular Scattering in Directions nearly parallel to that of the Exciting Beam.

The most elementary theory shows that the intensity of the scattered light in directions nearly parallel to that of the exciting beam should be only double the value observed in perpendicular directions. This follows from polarization considerations, for the light scattered in the parallel direction will be unpolarized, all of the components in the incident beam contributing to the illumination.

It is well known, however, that the light of the sky, even on a clear day and on the top of a mountain, is enormously brighter close to the sun than in distant regions of the sky.

At sea-level on a very clear day the light of the sky at 45° from the sun has only about 5 per cent. of the intensity shown close to the solar disk. This estimate was made by holding a mirror which reflected 5 per cent. of the incident light against the blue sky, and then observing the reflected image of the sky close to the sun, the solar disk being just hidden by a chimney. A very good intensity match was secured at about half a solar diameter from the sun, though the colour match was imperfect, the light from the region close to the sun appearing yellowish white in contrast to the blue sky. The mirror was an acute prism of glass with a knife edge, one surface being painted with black paint. The reflexion was observed in the glass surface, and measurements with a photometer showed that, at the angles commonly employed, the intensity of the reflected light was roughly 5 per cent. of the incident intensity. This device was employed subsequently in other experiments, and will be referred to in future as the 5 per cent. prism (4 per cent. reflexion from the front surface and 1 per cent. from the back).

While there appears to be no doubt but that the great intensity of the light in the vicinity of the sun is due entirely to diffraction by small particles, it appeared to be worth while to examine the scattering by dust-free air in a direction nearly coincident with that of the exciting rays. The experiment was made with a tube of galvanized iron 3 metres

long and 12 cm. in diameter, painted black inside. The ends were closed with wooden caps lined with black velvet; they are shown in section in fig. 1. The front cap was perforated by a hole 3 cm. in diameter near the edge of the tube,

Fig. 1.

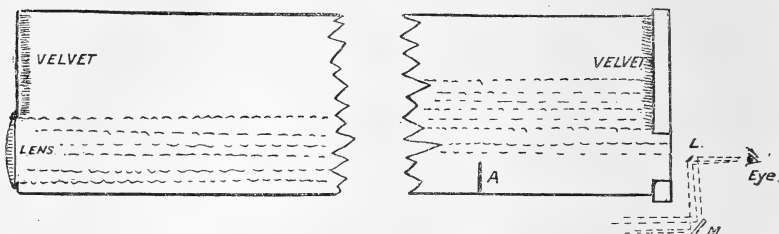

and a lens of 3 metres focus cemented over it. This lens forms an image of the sun at the opposite end of the tube of the same diameter as its clear aperture, consequently the tube is traversed by a cylindrical beam of sunlight of constant cross-section with sharp edges. The cap at the back of the tube was also perforated with a hole, which was covered with paper painted black with the exception of a narrow strip near the edge of the hole. A hole 3 mm. in diameter was burnt through the centre of the paper disk with a hot glass tube. A heliostat was mounted outside of the door of the laboratory and the sunlight reflected from a small mirror through the long-focus lens down the tube. By observing the unpainted portion of the paper disk the edge of the solar image was brought up to within about 5 mm. of the small aperture, through which the observations were made. A vertical diaphragm (A) concealed the lens and shut off the glare diffracted by its edges and small scratches on its surface. It was thus possible to bring the pupil of the eye up to within 5 mm. of the cylindrical beam of sunlight, and look diagonally across it down the tube at the black velvet background, the direction of vision making an angle of less than one degree with the light-rays. Before the introduction of filtered air the amount of light scattered along the path of the beam was considerable, each mote shining with dazzling brilliancy. With filtered air the velvet background appeared quite black, but the residual luminosity of the intervening air was at once apparent when examined with a simple piece of apparatus, which, for want of a better name, we may call a nigrometer. It is merely a tube of pasteboard 3 cm. in diameter and 40 cm.

long, painted black inside, with one end covered with a cap of thin black paper perforated with a hole 3 mm. in diameter. If the end of the tube is pressed into the socket of the eye and the tube directed towards some object, the blackness of which we wish to test, the hole is visible as a more or less feebly illuminated disk, unless the object is absolutely black, in which case the hole is invisible. It is advisable to have an extension tube projecting beyond the cap, otherwise the edge of the hole may be seen illuminated by diffracted light. This device is so sensitive that it will show the scattering of light by one foot of air on a clear day, illuminated by normal sunlight: in fact, I have detected the scattering of 1 foot of air illuminated by the light of the blue sky ten minutes before sunset. As a background I employed a black cave, a wooden box $1.5 \times 1 \times 1$ metres, with a hole 40 cm. square at the end, painted black inside and furnished with a curtain of black velvet at the back. This box is placed out of doors in the sunshine, the sun's rays being parallel to the ends. If the nigrometer is brought close up to the aperture, the hole at the end of the tube disappears, coming into view as a very pale bluish disk when we move back about 30 cm. If we look at the open window of a house 1000 feet away on a clear day it appears extremely black, and if we imagine this to be reduced to $1/1000$ of its intensity we should expect that the residual light would be unappreciable by the eye, yet this is what we actually see with our black cave at a distance of one foot.

Coming back now to our experiment with the long tube, we find that if we observe the interior with the nigrometer the scattered light is very conspicuous. If, now, the scattered intensity in directions nearly parallel to the exciting beam and in directions at right angles to it are as 2 to 1, the long tube should show an intensity twice as great as a stratum of air 3 metres in depth, traversed by sunlight in a direction perpendicular to the line of vision. This comparison was made in the following way on a very clear day. The dark cave previously referred to, was placed at a distance of 3 metres from the open door a little to one side of the heliostat. By means of a mirror and a silvered sliver of glass placed in front of the observation hole of the long tube, a photometric comparison was made without difficulty. All windows in the laboratory were darkened, and screens of black cardboard were mounted as required to exclude unnecessary light; the aperture of the door was also contracted with curtains and screens. It was found that the luminosity in front of the dark cave was at least twice as bright as that

shown by the dust-free air in the tube. This is about what we should expect, as the outside air was not free from foreign matter, and as will appear from experiments to be described presently, the scattering power of the air close to the earth's surface is from two to three times the average scattering power of the atmosphere taken as a whole. The colour of the luminosity in front of the dark cave was decidedly whiter than that seen in the tube, which also is to be expected. This experiment makes it appear probable that if the atmosphere were absolutely free from foreign matter, the sky would be no brighter at the sun's edge than at remote distances*. The performance of the long tube was very satisfactory: it was made from oddments from the junk heap, and the lens ground and polished from a piece of thin plate glass. The silvered glass slivers referred to are made by silvering a piece of plate glass, polishing the surface, and then breaking off thin scales by striking the edge with a hammer in a direction parallel to the silvered surface. The razor edge of one of these scales disappears when the photometric balance is secured quite as completely as the dividing line of a Lummer-Brodhun prism. The observation hole was left clear, as it was found that a glass cover was apt to send some light to the eye.

Scattering of Air close to the Earth's Surface.

This question was investigated by determining the depth of the stratum of air in full sunlight (observed against a black cave), necessary to give a luminosity equal to 5 per cent. of the luminosity of the blue sky 60° from the sun on the clearest days.

A 4.5-inch astronomical telescope was directed towards the black cave and the eyepiece removed. The real image of the aperture of the cave was then examined with the nigrometer, the 5-per cent. reflecting prism being held in front of the small circular hole in such a position that its thin edge bisected the aperture and reflected the light of the blue sky to the eye. On slightly hazy days an intensity match was secured with the cave at a distance of 400 feet, while on the clearest day of all the distance increased to a trifle over 1000 feet. Similar results were secured by observing the open doors and windows of distant buildings with the nigrometer without employing the telescope.

In discussing these results the question again comes up as

* Dr. Luckiesh and Mr. Nietz both report having frequently observed that at great altitudes (15,000 to 20,000 feet) the sky appears dark blue right up to the edge of the solar disk.

to the value which we are to assign to the intensity of the sunlight effective in illuminating the five miles of homogeneous atmosphere, if we consider the intensity at the earth's surface as 50 per cent. of its value in space. If we make the same assumption as before, we should expect for a very clear day $1000 \times 1/2 = 5$ per cent. of 26400×1 if the atmosphere were uniform in composition. To have this equation hold we must multiply the left-hand term by 2.64, which means that the scattering power of the air close to the earth's surface is about 2.6 times the average scattering power of the entire atmosphere.

These results appear to be in good agreement with Abbot's observations on atmospheric absorption (absorption in this case to be understood as the removal of energy from the primary beam of light by scattering). Abbot found that the loss of intensity due to passage through the lower mile of the atmosphere was equal to the loss suffered by passage through the entire atmosphere above the first mile. He also found that the intensity of the solar radiation for the middle of the visible spectrum at the earth's surface was about 50 per cent. of its value in space. If, now, we consider the atmosphere as an ocean of air at standard pressure five miles in depth (the 5-mile homogeneous atmosphere), and if we consider the percentage of foreign matter as constant throughout its mass, each mile will remove 12 per cent. of the energy from the light, and passage through the entire five miles will give a residual intensity of 53 per cent. of its original value. This 12 per cent. we may call the average absorbing power of one mile of the atmosphere, the quantity which we are to compare with the scattering power of 1000 feet of surface air observed with the dark cave. The facts of the matter are that most of the foreign matter is in the lower mile. Considering the atmospheric ocean as divided into two layers, a lower layer one mile in thickness and dust-laden and an upper layer of four miles free from dust, an absorption of 30 per cent. by each layer will be in close agreement with Abbot's results. This absorption of 30 per cent. by the lower mile is 2.5 times the *average* absorbing power of one mile of the homogeneous atmosphere, and is in good agreement with the observation that the scattering power of the air near the ground was 2.6 times the average scattering power of the entire atmosphere.

Demonstration Apparatus for the Laboratory.

The phenomenon of light scattering by pure gases is of such fundamental importance from a theoretical standpoint,

that apparatus for its exhibition to students should be in every physical laboratory. For demonstration purposes and for the investigation of rare gases, which it is difficult to keep pure in metal tubes with cemented windows, the following form of apparatus will be found superior in many respects to the branched metal tubes employed by Strutt in his investigations. The tubes are made wholly of glass, and can be hermetically sealed, insuring the continued purity of the gas, and they can be set up and exhibited at a moment's notice. They are prepared in the following way:—

A glass tube about 25 mm. in diameter and 25 or 30 cm. in length, is drawn down in an oblique direction at each end, as shown at A, fig. 2.

Fig. 2.

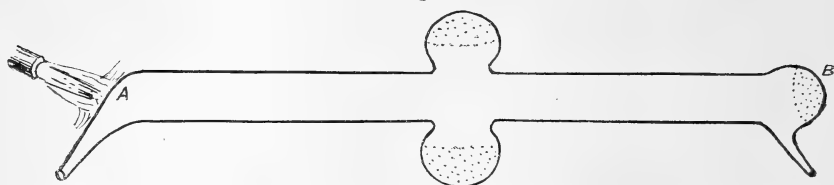

The flame of the blast-lamp is then directed against one end as shown in the figure, and the end blown out into a bulb, as shown at B.

This method of preparation obviates the necessity for sealing in lateral tubes for the admission of the gas, and will be found a great saver of time in the construction of all tubes for the study of the optical properties of gases and vapours. The other end of the tube is left as shown at A in the figure, as the sloping wall obviates the back reflexion of light from the bottom of the dark cave which this end of the tube is to form. Two lateral bulbs are next blown out from the wall of the tube: these should be as large as possible consistent with strength. Two tubes should be prepared, one filled with air filtered through densely packed cotton and the other with ether vapour, which has over twenty times the scattering power of air. The air can be forced into the tube through the filter with a tire-pump, and the small lateral tubes sealed-off with a flame. A small quantity of liquid ether is introduced into the other tube, and the entire tube warmed by sweeping it with a bunsen flame, or better by immersion in water heated to a temperature of about 40° C. The jet of vapour which escapes from the small tube can be ignited after waiting a few moments for the expulsion of the air. As the tube cools the flame dies down, and just as it is on the point of going out the small tube is sealed. The tubes are

now painted with thick black paint, with the exception of the dotted portion of the three bulbs. They are mounted in a horizontal position, and sunlight, reflected from a mirror, is focussed at the centre, with a 6-inch reading-glass, the light entering through one of the lateral bulbs and passing out through the other. Observations are made through the clear portion of the bulb B. A nigrometer with a hole about 8 mm. in diameter will be found of assistance in viewing the luminosity of the gas at the focus, though in the case of ether it can be seen at once even in a well-lighted room.

Summary.

1. The intensity of the light scattered by a given thickness of dust-free air in a tube illuminated by concentrated sunlight, has been compared photometrically with the light of the sky, by reducing the intensity of the latter until a match was secured. The ratio of the two intensities was compared with the calculated ratio, making certain assumptions in the case of the light of the sky, and a fair agreement found.

2. The intensity of the light scattered by dust-free air nearly in the direction of the incident light has been examined and found to be not very different from the intensity scattered in a perpendicular direction. It is theoretically twice as bright, but the conditions of the experiment did not permit of the determination of a difference of this amount. This indicates that the enormous increase in the intensity of the sky close to the sun's limb (over 20-fold) results from diffraction by motes in the air, and would be wholly absent if the atmosphere were perfectly clean.

3. The scattering power of the air near the ground on the clearest days in the country has been found to be about 2.6 times the average scattering power of the atmosphere.

XLII. *An Alternative View of Relativity.*

By Prof. FREDERICK SLATE, *University of California* *.

MANY expositions of relativity are marred at two points in the cogency of their aggressive argument for rejecting Newtonian dynamics. Where their reasoning is based explicitly or by implication on a statement of Newton's second law for constant inertia, supported by a "Principle of *vis viva*" requiring all work to be recorded as change of kinetic energy, these two restrictions foredoom to failure the

* Communicated by the Author.

attempt to use that narrowed Newtonian scheme in electronic dynamics. Is it not one typical or even unique function of the electron to effect reversible transformations between mechanical energy and field-structure? Restoring duly general form to Newton's relations for energy, momentum and force, leads immediately to an adjustment of relativity and Newtonian dynamics, eliminating alleged contradictions and re-establishing them as two properly equivalent procedures. Let us proceed to exhibit and confirm this, limiting the discussion, however, to the simplest case as a conclusive sample: An electronic particle in progressive rectilinear motion under electromagnetic field-forces.

Assuming a reference-frame (F), the tangential force (T) when inertia (*m*) is variable becomes

$$T \equiv \frac{d}{dt}(mv) = m \frac{dv}{dt} + v \frac{dm}{dt} \dots \dots (1)$$

Forces of this type are not invariant for frames (U) having unaccelerated translations (*u*) colinear with (*v*); the so-called "Newtonian transformation" loses validity. For any such frame an apparent force (*T_a'*) will be determined in relation to the observed force (*T_o*) by

$$T_a' \equiv m \frac{dv}{dt} + (v-u) \frac{dm}{dt}; \quad T_a' + u \frac{dm}{dt} = T_o \dots \dots (2)$$

The second equation here is significantly parallel with one connecting gravitation and weight. At the equator these are colinear, and

$$G_1 - m_1 r \omega^2 = W_1; \quad W_1 + m_1 r \omega^2 = G_1 \dots \dots (3)$$

Continuing, write for activity (A) and work (W)

$$A \equiv vT = mv \frac{dv}{dt} + v^2 \frac{dm}{dt} = \frac{d}{dt}(\frac{1}{2}mv^2) + \frac{1}{2}v^2 \frac{dm}{dt}; \dots \dots (4)$$

$$\begin{aligned} W \equiv \int_0^t vT dt &= \int_0^t \frac{d}{dt}(\frac{1}{2}mv^2) dt + \int_0^t \frac{1}{2}v^2 \frac{dm}{dt} dt \\ &= [E]_{t=0}^{t=t} + \frac{1}{2} \int_0^t v^2 \frac{dm}{dt} dt; \dots \dots (5) \end{aligned}$$

(E) denoting (molar) kinetic energy.

The first term gives still the aggregate change of kinetic energy, accommodated, however, to instantaneous values of (*m*) as well as of (*v*). But the second term can represent nothing except transformed work. Frequently, in physically

analysed cases, the second integral corresponds to changes of internal energy; which may be nearly reversible (elastic distortions) or practically irreversible (heat due to collision). Adaptation to the electronic conditions must follow up the former alternative. Before going further, remark that these two items, though primarily separated in equation (5), may be united by some artificial device: either the actual molar energy may be *attributed* to internal energy and recorded as such; or the internal energy may be entered fictitiously as additional (molar) kinetic energy. Both coalescences are only "book-keeping," exemplified also in the "two specific heats" of a gas. Relativity will be found to have exploited this open chance in handling energy-equations.

It is vital to the suppositions of equations (2) that the activity must be affected by the term $(u \, dm/dt)$. Granting that the force is (T_o) , we should recognize in a frame (U) only (T_a') and an activity

$$A' \equiv v' T_a' = (v-u) T_a' = (v-u) \left(T_o - u \frac{dm}{dt} \right). \quad (6)$$

Or intermediately, on any grounds recognizing (T_o) at invariant value,

$$A'' \equiv (v-u) T_o = (v-u) \left(T_a' + u \frac{dm}{dt} \right) = v' T_a' + uv' \frac{dm}{dt}. \quad (7)$$

Retaining the frame (F), adopt for it next the experimentally suggested law for (m) :

$$\frac{dm}{dv} = \frac{mv}{c^2 - v^2}; \quad \frac{dm}{dt} = \frac{mv}{c^2 - v^2} \frac{dv}{dt}. \quad (8)$$

Writing

$m_o \equiv [m]_{v=0}$ for the frame (F); and for any argument (z)

$\gamma(z) \equiv \left(1 - \frac{z^2}{c^2} \right)^{-\frac{1}{2}}$; (c) being light-speed in (F); straight-

forward algebra yields

$$T_o = m_o \gamma(v) \left(1 + \frac{v^2}{c^2 - v^2} \right) \frac{dv}{dt} = m_o \gamma^3(v) \frac{dv}{dt}; \quad (9)$$

$$v T_o = c^2 \frac{dm}{dt}; \quad W = c^2 m_o (\gamma(v) - \gamma(v_o)) = \frac{1}{2} \int_0^t v^2 \frac{dm}{dt} + [E]_0^t. \quad (10)$$

Noteworthy is the automatic vanishing of kinetic-energy change from the result. This harmonizes with the claim that electronic inertia is entirely electromagnetic as a corollary of equations (8). The work would then be absorbed entirely

into field-building. Remark further that in fact (dm/dt) may enter as an algebraic sum, embracing changes in electric and magnetic field; also the release of internal energy seemingly occurring in a deformable electron. The term $(\int_0^t \frac{1}{2}v^2 \frac{dm}{dt} dt)$ itself, therefore, must here be symbolic of a difference between change in "structural" energy and change in kinetic energy. With appropriate standardization of its zero-phase, it is in nature a kinetic potential. Interesting confirmation of our trend is the agreement in magnitude, for earlier accepted data, on segregating magnetic energy as kinetic, and the remainder as electric.

Identifying our (m_o) as the "Minkowski mass" of an electron, equations (9, 10) are formally identical with a group to which relativity has given currency; a remark extensible to the momentum-value

$$Q \equiv mv = m_o \gamma(v)v. \dots \dots (11)$$

Yet not without also making two qualifications: first, this derivation keeps (F) uniquely as basis, while the relativity-values apply to the specified group (U) equally; and secondly, this form of correspondence requires the limitation to constant inertia (m_o) [Relativity], as opposed to variable inertia (m) [Newton]. This indicated purchase-price for relativity's indifference toward any particular frame rewards closer scrutiny of its consequences; *e.g.*, imaginary force, and quaternionic velocity.

Connecting (F, U) are now relations verifiable directly from equations (2, 6, 8):

$$T_a' = \left(1 - \frac{uv}{c^2}\right) T_o; \quad v' T_o = \frac{v'}{1 - \frac{uv}{c^2}} T_a'; \quad v T_o = \frac{v}{1 - \frac{uv}{c^2}} T_a'. \quad (12)$$

Consequently if, without departure from c.g.s. units, we define a new variable speed (v_c') for (m) and recalculate:

$$v_c' \equiv \frac{v-u}{1 - \frac{uv}{c^2}} = \frac{v'}{1 - \frac{uv}{c^2}}; \quad v = \frac{v_c' + u}{1 + \frac{uv_c'}{c^2}};$$

$$\frac{v}{1 - \frac{uv}{c^2}} = \frac{v_c' + u}{\left(1 - \frac{uv}{c^2}\right)\left(1 + \frac{uv_c'}{c^2}\right)} = \gamma^2(u)(v_c' + u); \dots (13)$$

it follows that

$$v' T_o = v_c' T_a'; \quad v T_o = \gamma^2(u)(v_c' + u) T_a'. \dots (14)$$

In this aspect of "Einstein's theorem," which equations (13) in effect reproduce with altered meaning, it furnishes a rule for making compensations in activity, for disturbed value caused by passing over to a new frame (U). It is self-evident how the procedure can be reversed, correcting thus a distorted estimate in (F) of observations (or measurements) made in (U). Reading then the established rule for superposition of colinear "Lorentz transformations" in this novel sense, any linked succession of repeated distortions from original data can be traced through our frames (U), and the net compensation at any stopping-point determined. The proof is simple that the net effect (disturbance) is *nil* whenever the chain is a closed one.

Passing from activity to a similar analysis for tangential force, differentiate the first of equations (13) as a beginning. This gives

$$\frac{dv}{dt} = \left[\gamma(u) \left(1 - \frac{uv}{c^2} \right) \right]^2 \frac{d}{dt} (v_c'). \dots (15)$$

Hence, quoting the easily proved connexion

$$\gamma(u) \left(1 - \frac{uv}{c^2} \right) = \frac{\gamma(v_c')}{\gamma(v)}, \dots (16)$$

$$\begin{aligned} T_a' &= \left(1 - \frac{uv}{c^2} \right) m_o \gamma^3(v) \frac{dv}{dt} = \left(1 - \frac{uv}{c^2} \right)^3 \gamma^2(u) m_o \gamma^3(v) \frac{d}{dt} (v_c') \\ &= \frac{m_o}{\gamma(u)} \gamma^3(v_c') \frac{dv_c'}{dt}. \dots (17) \end{aligned}$$

We are brought thus to what is formally identical with the "transformation of Minkowski-force" (K):

$$\begin{aligned} \gamma(u) \left(1 - \frac{uv}{c^2} \right) T_o &= (\gamma(u) T_a'); \\ [T_o \equiv K(F); \gamma(u) T_a' \equiv K'(U)], \dots (18) \end{aligned}$$

not overlooking that Minkowski's "proper time" (and not "local time") replaces fluxion-time (*t*). All of this illuminates vividly the corresponding statements according to the method of relativity, and is readily seen to put in hand a complete control for a new aim of the whole system of calculative detail that flies the flag of "non-Newtonian mechanics." The particulars of that restoration to the older allegiance need not concern us here, beyond showing how the work-equation is equally tractable.

Let the interval begin at (*v*=*u*). Then for the apparent

manifestation in (U) of work associated with a process in (F), we have after a short reduction,

$$\int_0^t T_c(v-u)dt = c^2 m_o \left[\gamma(v) \left(1 - \frac{uv}{c^2} \right) - \frac{1}{\gamma(u)} \right] \\ = c^2 \frac{m_o}{\gamma(u)} (\gamma(v_c') - 1), \quad (19)$$

to match equation (7). This can also be written :

$$\int_0^t (T_a' \gamma(u)) v_c' dt = c^2 m_o (\gamma(v_v') - 1); \quad (20)$$

in a symmetrical form that fixed one goal of a Lorentz transformation. With the aid of equations (14), a similar recasting of work due to the activity (Λ') can be executed; and in any like case the transition to local time in the explicit time-factors can be added, rounding out the restatement. "Implicit time" (as the phrase goes) occurs already in (v_c').

All these latter developments can be made reciprocal between (F) and (U), by adding as a starting-point for reversal the value (v_c) altered from (v):

$$v_c \equiv \frac{v' + u}{1 + \frac{uv'}{c^2}}; \quad v' = \frac{v_c - u}{1 - \frac{uv_c}{c^2}}; \quad \frac{v'}{1 + \frac{uv'}{c^2}} = \gamma^2(u) (v_c - u). \quad (21)$$

Mathematically judged, there is no essential distinction to uphold between the direct and the reversed process of revision. Neither does mathematics attach any such decision to equation (3): whether (W_1) or (G_1) is "truer"; the *relation* is sufficient. On that side, the formulations being shown mathematically equivalent, the need of preferential discrimination would cease as regards the Newtonian scheme and relativity. But, as pointed out already, electronic dynamics can be cast, like gravitation, into terms of a potential, though the two potentials are unlike in type. Yet the use of either draws in the same requirement of co-ordinating by means of some conventional zero-point all possible stages of every problem into which one of the potentials enters. Unless the sequence of thought outlined above can be controverted, the unconstrained parallel to choosing "zero-point at infinity" for gravitation is clearly forecast. Select some frame (F) to which (m_o) belongs as an absolute minimum for $\gamma(u)=1$; that is $u=0$. This is plausibly indistinguishable from an "Ultimate frame for planetary motions" [Laue]. The reiterated occurrence of

the important factor ($\gamma(u)$) seems to leave no escape. The (superficially) uncoördinated employment of the Lagrange function which proves a salient characteristic of relativity; that is, making a new zero for each frame; as in the elementary case of a lifted body and its weight, would in effect disregard that factor ($\gamma(u)$). But, as we see, to eliminate that factor is detrimental to the full attainment of symmetry. Logarithmic fundamental relations prevent the mere "butt-joint" arrangement that is allowed for vertical intervals and weight. A discontinuity of energy values is avoidable only by some form of agreement that has for corollaries: Invariant transition at the "junction" with a new frame; and then equal activity reckoned for the same time-unit. Relativity contrives to satisfy these conditions however indirectly; at times its perhaps unavowed goal is masked behind an almost opaque veil of four-dimensional mathematics. Yet no just mind would endure cancelling anything of that brilliant achievement of expansion. Once more in physics an inestimable service had its source seemingly in a misapprehended premiss—about Newton's second law and *vis viva*.

The matter is weighty enough, if it resolves a puzzling riddle, to call for immediate publishing in condensed outline of the line of varied attack. A prepared paper discussing the subject less summarily cannot appear for several months.

University of California.
September 12, 1919.

XLI. *Applications of Quaternions to the Theory of Relativity.*
By H. T. FLINT, M.Sc., Lecturer in Physics, University
College, Reading*.

Introduction.

IN this paper it is proposed to express the results of Relativistic Dynamics by means of quaternions. It amounts to expressing the Minkowski four-vector as a quaternion, and bringing about its transformation by a certain operator introduced by Silberstein †. It is shown in the paper, of which the reference is given, that the Lorentz-Einstein transformation is equivalent to

$$q' = Q[g]Q.$$

q' is a quaternion considered in a system of reference S'

* Communicated by Professor W. G. Duffield, D.Sc.

† Phil. Mag. May 1912.

moving with velocity, v , with respect to a system, S , along a direction denoted by the unit vector \mathbf{v} .

The vector part of q' is \mathbf{r}' , the vector from the origin to a point P' , and the scalar is l' where $l' = it'$, t' is the time in S' and is measured in units in which the velocity of light is unity. q is similarly $\mathbf{r} + l$, in S .

Q is also a quaternion, and expressed in detail is

$$\frac{1}{\sqrt{2}} \left\{ (1 + \beta)^{\frac{1}{2}} + (1 - \beta)^{\frac{1}{2}} \mathbf{v} \right\}$$

where $\beta = (1 - v^2)^{-\frac{1}{2}}$.

It is to be applied in front of and behind the quantity to be transformed and obeys, of course, the rules of multiplication of quaternion analysis.

Expressions like q , which transform in this way, are called physical quaternions, and evidently such quantities, like four-vectors, are capable of expressing the theory of Relativity, in fact, they are just what is required.

We here consider the application of this notation to velocity, force, and momentum.

It will be seen that the well-known results of the Cartesian mode of expression are easily derived, but the results obtained are more general and have no special reference to axes.

An expression for the kinetic energy of a particle, slightly different from that usually accepted, is indicated by the notation. This form has been discussed elsewhere by W. Wilson*.

Application to electric and magnetic forces give quite general transformations, and we again recognize by reference to special directions the Cartesian formulæ resulting. Finally, the problem of the field due to a uniformly moving charge is solved by a very easy application of the general formulæ.

1. Notation.

τ will be used in its usual meaning, so that

$$(d\tau)^2 = -(dx^2 + dy^2 + dz^2 + dl^2) = (1 - u^2)dt^2 = \frac{1}{k^2} dt^2 \quad (\text{say})$$

$$\text{if} \quad u^2 = \left(\frac{dx}{dt}\right)^2 + \left(\frac{dy}{dt}\right)^2 + \left(\frac{dz}{dt}\right)^2.$$

$d\tau$ is an element of the "proper time" and is invariant in our transformations.

* Proc. Phys. Soc. xxxi. pt. ii. p. 74.

Write $q = \mathbf{a} + \lambda$

so that $\mathbf{a}' + \lambda' = Q(\mathbf{a} + \lambda)Q$.

It follows that

$$\mathbf{a}' = \lambda(1 - \beta^2)^{\frac{1}{2}}\mathbf{v} + \mathbf{a} + \mathbf{v}(1 - \beta)S\mathbf{a}\mathbf{v} \quad \dots \quad (\text{i.})$$

and $\lambda' = \beta\lambda + (1 - \beta^2)^{\frac{1}{2}}S\mathbf{a}\mathbf{v} \quad \dots \quad (\text{ii.})$

2. From the quaternion q we pass to

$$w = \frac{d}{d\tau} q.$$

We may describe w as the velocity quaternion. It is evidently a physical quaternion, for $d\tau$ is invariant.

This statement, or what is the same thing,

$$w' = QwQ,$$

contains all that need be said about transformation of velocities. It is, however, interesting to derive the well-known formulæ. We have

$$w' = \frac{d}{d\tau} (\mathbf{r}' + l) = Q \frac{d}{d\tau} (\mathbf{r} + l)Q.$$

Thus by (i.) and (ii.)

$$\frac{d\mathbf{r}'}{d\tau} = \frac{dl}{d\tau} (1 - \beta^2)^{\frac{1}{2}}\mathbf{v} + \frac{d}{d\tau} \mathbf{r} + \mathbf{v}(1 - \beta)S \frac{d}{d\tau} \mathbf{r} \cdot \mathbf{v}, \quad (\text{iii.})$$

and

$$\frac{dl'}{d\tau} = \beta \frac{dl}{d\tau} + (1 - \beta^2)^{\frac{1}{2}}S \frac{d\mathbf{r}}{d\tau} \cdot \mathbf{v} \quad \dots \quad (\text{iv.})$$

From (iv.)

$$\frac{1}{(1 - u'^2)^{\frac{1}{2}}} = \frac{\beta}{(1 - u^2)^{\frac{1}{2}}} + \frac{v\beta}{(1 - u^2)^{\frac{1}{2}}} S \frac{d\mathbf{r}}{dt} \cdot \mathbf{v}, \quad (\text{v.})$$

and if \mathbf{v} is taken along Ox this gives

$$\left(\frac{1 - u^2}{1 - u'^2} \right)^{\frac{1}{2}} = \beta(1 - vu_x). \quad \dots \quad (\text{vi.})$$

This is the well-known and important transformation of $(1 - u'^2)$.

From (iii.) by making use of (vi.)

$$u'_x = \frac{u_x - v}{1 - vu_x}.$$

Similarly, we may derive

$$u_y' = \frac{u_y}{\beta(1-vu_x)} \quad \text{and} \quad u_z' = \frac{u_z}{\beta(1-vu_x)}$$

by taking \mathbf{v} along Oy and Oz respectively.

3. Let m_0 denote the "rest mass" of a particle, and then

$$\mathbf{M} = m_0 \mathbf{w}$$

is also a physical quaternion—the momentum quaternion.

We obtain from § 2

$$\frac{m_0}{(1-u'^2)^{\frac{1}{2}}} = \frac{m_0}{(1-u^2)^{\frac{1}{2}}} \beta(1-vu_x), \dots \dots \dots \text{(vii.)}$$

or writing this

$$m' = m\beta(1-vu_x)$$

we obtain the usual transformation for mass.

4. By a second differentiation we pass to acceleration and write :

$$f = \frac{dw}{d\tau}.$$

Transformation of acceleration is completely expressed by

$$f' = QfQ.$$

5. We write

$$P = m_0 f$$

and call P the physical force quaternion.

We then have

$$m_0 \left(\frac{d^2 \mathbf{r}'}{d\tau'^2} + \frac{d^2 l^2}{d\tau'^2} \right) = P' = Q m_0 \left(\frac{d^2 \mathbf{r}}{d\tau^2} + \frac{d^2 l}{d\tau^2} \right) Q.$$

Thus

$$m_0 \frac{d^2 \mathbf{r}'}{d\tau'^2} = i m_0 \beta v \mathbf{v} \frac{d^2 l}{d\tau^2} + m_0 \frac{d^2 \mathbf{r}}{d\tau^2} + \mathbf{v} (1 - \beta) m_0 S \frac{d^2 \mathbf{r}}{d\tau^2} \cdot \mathbf{v}, \text{ (viii.)}$$

and

$$m_0 \frac{d^2 l^2}{d\tau'^2} = m_0 \beta \frac{d^2 l}{d\tau^2} + m_0 i \beta v S \frac{d^2 \mathbf{r}}{d\tau^2} \cdot \mathbf{v} \dots \dots \dots \text{(ix.)}$$

If \mathbf{v} is along Ox we find from (ix.)

$$\frac{dm'}{dt'} = \frac{dm}{dt} - \frac{mv}{(1-vu_x)} \cdot \frac{du_x}{dt} \dots \dots \dots \text{(x.)}$$

Writing $F_x = \frac{d}{dt}(m_0 u_x)$ etc. we find from (viii.)

$$F_x' = \frac{F_x - v \frac{dm}{dt}}{1 - vu_x} = F_x - \frac{vu_y}{1 - vu_x} F_y - \frac{vu_z}{1 - vu_x} F_z \quad \left. \vphantom{F_x'} \right\} \text{(xi.)}$$

and similarly,

$$F_y' = \frac{F_y}{\beta(1 - vu_x)}, \quad F_z' = \frac{F_z}{\beta(1 - vu_x)}$$

These are Planck's equations for transformation of force.

6. If mass be regarded as a manifestation of contained energy we may, on this view, regard m_0 as a measure of the energy of a body at rest.

The expression for the energy is $\frac{m_0}{(1-u^2)^{\frac{1}{2}}}$. Thus the scalar term $m_0 \frac{dl}{d\tau}$ of M is equal to i (energy).

From the definition of $d\tau$ we have

$$(d\tau)^2 = (d\mathbf{r})^2 - (dl)^2. \quad \dots \dots \text{(xii.)}$$

Hence $\left(\frac{d\mathbf{r}}{d\tau}\right)^2 - \left(\frac{dl}{d\tau}\right)^2 = 1$

and $\frac{d}{d\tau} \left(\frac{d\mathbf{r}}{d\tau}\right)^2 = \frac{d}{d\tau} \left(\frac{dl}{d\tau}\right)^2$,

or $S \frac{d\mathbf{r}}{d\tau} \cdot \frac{d^2\mathbf{r}}{d\tau^2} = \frac{dl}{d\tau} \cdot \frac{d^2l}{d\tau^2} \dots \dots \text{(xiii.)}$

Multiply throughout by m_0 and the term on the left becomes

$$\frac{1}{(1-u^2)} \frac{d}{dt} \left\{ m \frac{d\mathbf{r}}{dt} \right\}.$$

On the right we have

$$- \frac{1}{(1-u^2)} \frac{d}{dt} \left\{ \frac{m_0}{(1-u^2)^{\frac{1}{2}}} \right\}.$$

Thus

$$-S \frac{d\mathbf{r}}{dt} \cdot \frac{d}{dt} \left(m \frac{d\mathbf{r}}{dt} \right) = \frac{d}{dt} \left\{ \frac{m_0}{(1-u^2)^{\frac{1}{2}}} \right\}.$$

This equation represents the principle of conservation of energy, for on the left we have the activity of the force and on the right the rate of change of energy.

If Kw denotes the quaternion conjugate to w and P is the force quaternion, the equivalent of (xiii.) is

$$SP \cdot Kw = 0. \quad \dots \dots \dots \text{(xiv.)}$$

This is the same as the condition for constancy of internal energy given in the 'Theory of Relativity'*.

The quaternion Kw or any physical quaternion of the form

$$q_c = l - \mathbf{r}$$

is transformed to S' by the operation $Q_c q_c Q_c$, where Q_c is derived from Q by writing $-\mathbf{v}$ instead of \mathbf{v} †.

Transformed to S' , $SP \cdot Kw$ becomes

$$SP'Kw' = SQPQ \cdot Q_c Kw Q_c = SQPKw Q_c.$$

Thus PKw is an "R" quaternion ‡ whence its scalar is invariant. Thus $SP'Kw' = 0$, or the principle of energy is invariant.

7. From (xiii.) we obtain a more general result by regarding the term on the right, viz. $\frac{dl}{d\tau} \frac{d}{d\tau} \left(\frac{dl}{dt} \right)$ prefixed with the negative sign and multiplied by m_0 as the rate of change of energy, *i. e.*

$$\frac{d}{d\tau} (\text{energy}) = - \frac{dl}{d\tau} \frac{d}{d\tau} \left(m_0 \frac{dl}{d\tau} \right).$$

This leads to the expression $\frac{1}{2} m_0 k^2$ for the energy, omitting an arbitrary constant.

We may denote the kinetic energy by the expression

$$\frac{1}{2} m_0 (k^2 - 1) \S.$$

It has been pointed out by Jeffreys || that while there is a certain arbitrariness in the choice of the exact form for the kinetic energy there is convenience in the adoption of this form.

This expression, like $m_0(k-1)$, reduces to the ordinary value $\frac{1}{2}mv^2$ for velocities very much smaller than that of light.

* Cunningham, Theory of Rel. p. 167.

† Silberstein, Phil. Mag. May 1912.

‡ Silberstein, *ibid.*

§ Cf. W. Wilson, Proc. Phys. Soc. xxxi. pl. ii. p. 74.

|| H. Jeffreys, Phil. Mag. July 1919.

8. The equation of motion is to be written

$$P = m_0 \frac{d^2 q}{d\tau^2},$$

where $P = \mathbf{F} + \mathbf{A}$ and the relation between the scalar and vector parts of P is

$$iKA = S \frac{d\mathbf{r}}{d\tau} \mathbf{F},$$

and this is the same as

$$SKwP = 0.$$

9. An examination of P shows that it is constructed so that

$$\mathbf{F} = k\mathbf{p} \quad \text{and} \quad \mathbf{A} = ik \frac{dw}{dt},$$

where \mathbf{p} is the force as it enters into ordinary mechanics, and $\frac{dw}{dt}$ is the rate of change of energy.

We may easily derive the force in S' in terms of the S measure. We have merely to transform P' ,

$$P' = \mathbf{F}' + \mathbf{A}' = Q(\mathbf{F} + \mathbf{A})Q.$$

Equations (i.) and (ii.) give immediately

$$\mathbf{F}' = \mathbf{A}(1 - \beta^2)v + \mathbf{F} + \mathbf{v}(1 - \beta)S\mathbf{F}\mathbf{v} \quad \dots \quad (\text{xiv.})$$

and

$$\mathbf{A}' = \beta\mathbf{A} + (1 - \beta^2)^{\frac{1}{2}}S\mathbf{F}\mathbf{v} \quad \dots \quad (\text{xv.})$$

$$\therefore k'\mathbf{p}' = -k\beta v \frac{dw}{dt} \cdot \mathbf{v} + \mathbf{F} + k(1 - \beta)\mathbf{v}S\mathbf{p}\mathbf{v}.$$

Using the ratio $\frac{k}{k'}$ given by (v.)

$$\mathbf{p}' = \frac{\mathbf{p} + \mathbf{v}(1 - \beta)S\mathbf{p}\mathbf{v} - v\beta\mathbf{v}\frac{dw}{dt}}{\beta(1 + vS\mathbf{u}\mathbf{v})}, \quad \dots \quad (\text{xvi.})$$

and in the same way

$$\frac{dw'}{dt'} = \frac{\frac{dw}{dt} + vS\mathbf{p}\mathbf{v}}{1 + vS\mathbf{u}\mathbf{v}} \quad \dots \quad (\text{xvii.})$$

These two equations represent the general transformation, and there is no particular direction for the vectors occurring in them. Equations (xi.) are particular cases.

As an example, we may apply the transformation to the mechanical force on a moving charge.

Thus if
$$\mathbf{p} = \mathbf{E} + \mathbf{V}\mathbf{u}\mathbf{H}, \quad \frac{dw}{dt} = -\mathbf{S}\mathbf{E}\mathbf{u},$$

and making use of the Principle of Relativity, the physical laws being unaltered by transferring to S' .

We have

$$\mathbf{p}' = \mathbf{E}' + \mathbf{V}(\mathbf{u}'\mathbf{H}'), \quad \frac{dw'}{dt'} = -\mathbf{S}\mathbf{E}'\mathbf{u}'.$$

On making the appropriate substitutions in (xvi.) and (xvii.) and remembering that

$$\mathbf{u}' = \frac{\mathbf{u} + \mathbf{v}(1 - \beta)\mathbf{S}\mathbf{u}\mathbf{v} - \beta\mathbf{v}\mathbf{v}}{\beta(1 + \mathbf{v}\mathbf{S}\mathbf{u}\mathbf{v})} \dots \dots \dots \text{(xviii.)}$$

We find

$$\mathbf{E}' + \mathbf{v}(1 - \beta)\mathbf{S}\mathbf{E}'\mathbf{v} = \beta(\mathbf{E} - \mathbf{v}\mathbf{V}\mathbf{H}\mathbf{v}), \dots \dots \text{(xix.)}$$

and this contains the well-known formulæ

$$\mathbf{E}'_x = \mathbf{E}_x, \quad \mathbf{E}'_y = \beta(\mathbf{E}_y - \mathbf{v}\mathbf{H}_z), \quad \mathbf{E}'_z = \beta(\mathbf{E}_z + \mathbf{v}\mathbf{H}_y).$$

On application to the expression $(\mathbf{H} - \mathbf{V}\mathbf{u}\mathbf{E})$ we obtain in the same way

$$\mathbf{H}'_x = \mathbf{H}_x, \quad \mathbf{H}'_y = \beta(\mathbf{H}_y + \mathbf{v}\mathbf{E}_z), \quad \mathbf{H}'_z = \beta(\mathbf{H}_z + \mathbf{v}\mathbf{E}_y),$$

or
$$\mathbf{H}' + \mathbf{v}(1 - \beta)\mathbf{S}\mathbf{H}'\mathbf{v} = \beta(\mathbf{H} + \mathbf{v}\mathbf{V}\mathbf{E}\mathbf{v}). \dots \dots \text{(xx.)}$$

10. *The Field due to a uniformly moving electron.*

The case of the uniformly moving electric charge can be easily dealt with by means of equations (xvi.) and (xvii.).

The problem is to determine the field at a point in system S due to a charge moving with velocity $\mathbf{v}\mathbf{v}$. If the system S' moves with this velocity the charge is at rest in that system, and from the point of view of S' observers the case is electrostatic.

Consider a charge, e , at rest in S' and suppose there is a unit charge at a point P' moving with velocity \mathbf{u}' . We shall ultimately write $\mathbf{u}' = -\mathbf{v}\mathbf{v}$, so that P' is at rest in S .

The force on P' is

$$\mathbf{p}' = \frac{e}{r'^2} \cdot \mathbf{r}'_1 = \frac{e}{r'^3} \cdot \mathbf{r}',$$

where \mathbf{r}'_1 is the unit vector in the direction from e to P' .

Let e be situated at the origin for convenience. Also

$$\frac{dw'}{dt'} = -\frac{e}{r'^3} \cdot \mathbf{S}\mathbf{u}'\mathbf{r}',$$

where r'^3 means the cube of the tensor of \mathbf{r}' .

Thus from (xvi.) by applying the transformation from S' to S , *i. e.*, writing $-\mathbf{v}$ instead of \mathbf{v} in the formula

$$\mathbf{p} = \frac{1}{\beta(1 - vSu'\mathbf{v})r'^{1/3}} \cdot \left\{ \mathbf{r}' + \mathbf{v}(1 - \beta)Sr'\mathbf{v} - v\beta\mathbf{v}Su'\mathbf{r}' \right\},$$

or writing $\mathbf{u}' = -v\mathbf{v}$ and after a simple modification

$$\mathbf{p} = \frac{\beta e}{r'^{1/3}} \left\{ \mathbf{r}' + \mathbf{v}Sr'\mathbf{v} \left(1 - \frac{1}{\beta} \right) \right\}. \dots \dots \text{(xxi.)}$$

It is, of course, natural to measure from the instantaneous position of the moving charge e , as it is viewed by observers at rest in S . It is easy to take this new point of reference.

For let the instant in S' be zero, *i. e.*, $t' = 0$. From (i.)

$$\mathbf{r}' = -v\beta\mathbf{v}t + \mathbf{r} + \mathbf{v}(1 - \beta)Srv,$$

and from (ii.)

$$t' = \beta(t + vSrv).$$

These are merely the Lorentz-Einstein formulæ.

If $t' = 0$,

$$t = -vSrv$$

$$\therefore \mathbf{r}' = \mathbf{r} + \mathbf{v}Srv \left(1 - \frac{1}{\beta} \right). \dots \dots \text{(xxii.)}$$

If O is the initial position of the electron, *i. e.*, its position at time $t = 0$, in the interval $-vSrv$ it will have moved to e where Oe is $-v^2\mathbf{v}Srv$.

Fig. 1.

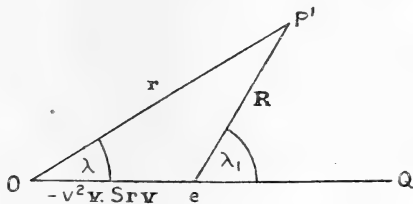

We require our formula in terms of \mathbf{R} and possibly the angle $P'eQ$; OQ is the direction of motion of the electron.

On substitution for \mathbf{r}' in (xxi.)

$$\mathbf{p} = (\mathbf{r} + v^2\mathbf{v}Srv) \frac{\beta e}{r'^{1/3}} = \frac{\beta e}{r'^{1/3}} \cdot \mathbf{R}, \dots \dots \text{(xxiii.)}$$

as is easily seen from the figure.

But

$$\mathbf{p} = \mathbf{E} + \mathbf{V}\mathbf{u}\mathbf{H},$$

and since

$$\mathbf{u} = 0, \quad \mathbf{p} = \mathbf{E},$$

\mathbf{E} is the electrical intensity at P and the formula (xxiii.) shows that it is directed along \mathbf{R} , the line joining P to the instantaneous position of the electron.

From (xx.) since $\mathbf{H}' = 0$ the magnetic intensity due to the charge is

$$\mathbf{H} = -v\mathbf{V}\mathbf{E}\mathbf{v} = v\mathbf{V}\mathbf{v}\mathbf{E}.$$

This immediately shows that \mathbf{H} is perpendicular to \mathbf{v} and \mathbf{E} , and in such a direction that a right-handed screw placed along the direction would rotate \mathbf{v} into \mathbf{E} .

It is immediately seen from the figure that the magnitude of \mathbf{H} is $vE \sin \lambda_1$.

It remains to put r'^3 in terms of R , these quantities denoting the magnitudes OP' and eP' .

Fig. 2.

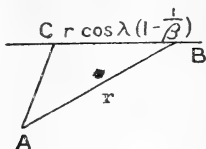

λ denotes the angle between \mathbf{r} and the direction \mathbf{v} . Thus

$$\mathbf{r}' = \mathbf{r} - \mathbf{v}r \cos \lambda \left(1 - \frac{1}{\beta}\right).$$

Thus

$$\mathbf{r}' = \mathbf{AC}.$$

It immediately follows that

$$r'^2 = r^2(1 - v^2 \cos^2 \lambda).$$

Again from fig. 1

$$R^2 = r^2(1 - 2v^2 \cos^2 \lambda + v^4 \cos^2 \lambda)$$

and

$$\frac{R}{\sin \lambda} = \frac{r}{\sin \lambda'}.$$

From these equations we derive

$$r'^2 = \beta^2 R^2 (1 - v^2 \sin^2 \lambda_1).$$

Thus

$$\mathbf{E} = \frac{e\mathbf{R}_1}{\beta^2 R^2 (1 - v^2 \sin^2 \lambda_1)^{\frac{3}{2}}},$$

\mathbf{R}_1 is the unit vector along $e\mathbf{P}'$, and

$$\mathbf{H} = v\mathbf{E} \sin \lambda_1.$$

These results are of course well known, but I think it will be admitted that the above is a particularly easy way of obtaining them. By extension of the principle described to quaternionic operators it is evident that the whole of the theory of Relativity can be very conveniently expressed in this notation.

In conclusion I should like to express my thanks to Dr. Silberstein for reading my paper and for his interest in it.

XLIV. *The Constitution of Atmospheric Neon.* By F. W. ASTON, M.A., D.Sc., Clerk Maxwell Student of the University of Cambridge*.

[Plates VIII. & IX.]

IN periodic tables of the elements arranged in order of their atomic weights the part lying between Fluorine on the one hand and Sodium on the other is of considerable interest.

Soon after the discovery of argon and while the mono-atomic nature of its molecule was still under discussion, Emerson Reynolds, in a letter to 'Nature' (March 21, 1895), described a particular periodic diagram which he had used with advantage. In this letter, referring to the occurrence of the groups Fe, Ni, Co: Ru, Rh, Pd: and Os, Ir, Pt, the following passage occurs:—

“ . . . the distribution of the triplets throughout the whole of the best known elements is so nearly regular that it is difficult to avoid the inference that three elements should also be found in the symmetrical position between 19 and 23, *i. e.* between F and Na, . . . of which argon may be one . . . ”

In 1898 neon was isolated from the atmosphere, in which it occurs to the extent of .00123 per cent. by volume, by

* Communicated by the Author.

Ramsay and Travers, and was accepted as an elementary monatomic gas of the helium group. Its density was measured with extreme care by Watson (J. C. S. Trans. vol. i. p. 810 (1910)), and found to correspond with an atomic weight 20.200 ($O=16$), making it the lightest element to diverge from the whole number rule in an unmistakable manner.

Neon has many very remarkable properties, its compressibility, viscosity, and dielectric cohesion are all abnormal; but the first suggestion that it might be a mixture was the observation in 1912 by Sir J. J. Thomson of a faint but unmistakable parabola at a position corresponding roughly to an atomic weight 22, in addition to the expected one at 20, in positive ray photographs, whenever neon was present in the discharge-bulb (*v.* 'Rays of Positive Electricity,' p. 112). The first plate which showed this was obtained from a sample of the lighter constituents of air supplied by Sir James Dewar; other specimens of impure neon gave a similar result. So also did a portion of the gas used by Watson in the atomic weight determinations, which fact, together with the complete invisibility of any parabola at 22 on hundreds of plates where neon was known to be absent, was very strong evidence that the line was ascribable to neon and to neon alone.

These facts led the author to undertake a searching investigation on the constitution of the gas by two distinct lines of attack, firstly attempts at separation, secondly accumulation of the evidence obtainable by positive rays.

Evidence of Separation.

The experiments on fractional distillation and fractional diffusion through pipeclay have already been described (F. A. Lindemann and F. W. Aston, Phil. Mag. vol. xxxvii. May 1919). The former were completely negative and only succeeded in confirming Watson's value of the density already referred to. It has recently been shown (F. A. Lindemann, Phil. Mag. July 1919) that this negative result was theoretically inevitable.

The diffusion results were more hopeful, an apparent change of density of about .7 per cent. being obtained in the first set of experiments. On the other hand, the more elaborate automatic apparatus started in 1914 has given very disappointing results, a difference of only .3 per cent. being obtained. This is doubtless due to the initial mistake in designing the apparatus to work at atmospheric pressure,

under which conditions the mixing is very bad. It may therefore be said that the diffusion results are positive but too small to be conclusive.

Evidence of Positive Rays.

This is available on three distinct counts: the character of the lines, their position and their intensity.

Character of the parabolas.

Plate VIII. shows a dark and a light print taken from a negative obtained in 1913 by Thomson's method of analysis from a gas containing a large percentage of neon. The line due to the lighter constituent which will be called Ne^{α} can easily be recognized as the brightest on the plate, the Ne^{β} *i. e.* 22 line being the fainter one immediately below it. It can easily be seen that the latter possesses characteristics identical in all but intensity with those of the former. As has already been pointed out ('Rays of Positive Electricity,' p. 111) the prolongation of the lines towards the vertical axis indicates that the particles causing them are capable of carrying more than one charge; multiple charges not occurring on molecules but only on atoms, one is led to infer that both lines are due to elements.

Position of the parabolas.

Measurements of plates obtained in this way indicated that it was probable that the lighter constituent did not correspond in mass with the accepted atomic weight of 20.2, but the accuracy was not sufficient to make this certain.

Intensity of the parabolas.

The relative intensity of the Ne^{α} and Ne^{β} parabolas obtained from atmospheric neon untreated by diffusion has been estimated by three different observers as about 10 to 1. Its apparent invariability is corroborative evidence against the possibility of the 22 line being due to the presence of other gases in the discharge-bulb.

It will be seen that although by Thomson's system of analysis the presence of two isotopes in atmospheric neon was indicated by several lines of reasoning, none of them can be regarded as quite conclusive, and it was realized that, failing separation, the most satisfactory proof would be afforded by measurements of atomic weight so accurate as to prove beyond dispute that neither constituent corresponded with the accepted atomic weight of atmospheric neon.

Evidence of the Positive Ray Spectrograph.

The "mass-spectra" yielded by the new method of positive ray analysis recently described (F. W. Aston, *Phil. Mag.* Dec. 1919) supply these measurements in an entirely satisfactory manner. Plate IX. A, B, C, D, are prints from negatives obtained by means of this apparatus. Each contains a number of spectra taken with different electric and magnetic fields; the following table of values of P the potential between the electrostatic plates in volts, I the current passing through the magnet in amperes, and T the time of exposure in minutes, is given for reference:—

TABLE I.

A					B				
1	2	3	4	5	1	2	3	4	5
P= 240	240	240	320	320	320	320	360	240	240
I=·130	·450	·600	·600	·800	·351	·600	·600	·600	·173
T= 4	10	10	10	10	15	15	15	15	4

C						D					
1	2	3	4	5	6	1	2	3	4	5	6
P= 240	240	280	320	360	360	320	320	320	320	320	320
I=·380	·550	·550	·550	·550	·700	·482	·520	·554	·606	·701	·798
T= 15	15	15	15	15	10	10	10	10	10	10	10

On the left of each spectrum can be seen the small circular dot photographed on the plate just before or during the exposure, this is used as a register spot for measuring purposes.

Plate A was taken with carbon monoxide. That is to say, the vacuum in the discharge-tube was maintained by continual pumping with a Gaede rotating mercury pump against a small leak of CO. It must be understood that this does not imply that the contents of the discharge-bulb were pure CO, since the use of tap-grease and wax joints necessitates the presence of hydrocarbons, etc., but at least one can be certain that the quantity of neon present was negligible as none had yet been put into the apparatus. The electric deflexion is away from the register spot, the magnetic towards it, so that the heavier masses are to the right of lighter ones.

Spectrum A I. was taken with a very small magnetic field showing the lines due to the hydrogen atom and molecule. In A II. the field has been increased and a group of five lines are seen. These, which may be called the C₁ group, are 12-C, 13-CH, 14-CH₂ (or N), 15-CH₃, 16-CH₄ (or O).

They are important lines of reference and are certainly of the relative masses given above to the order of accuracy (one-tenth per cent.) claimed in the present experiment.

In A IV. the deflexion has been still further increased and a new group of lines, the C_2 group 24, 25, 26, 27, 28, 29, 30 containing the strong reference line of CO (or C_2H_4), have come into view. In A III. of the C_1 group only 15 and 16 are visible, and in A V. the C_2 group has moved to the left and the strong line 44, CO_2 is seen to the right.

Plate B was taken with CO to which about 20 per cent. of atmospheric neon had been added. Considering the spectrum B III. it will be seen that four unmistakably new lines have made their appearance, one pair between the C_1 and C_2 groups, another weaker pair to the left of the C_1 group. The first pair are $(Ne^\alpha)^+$ 20 and $(Ne^\beta)^+$ 22 singly charged, the second pair are the same atoms with double charges $10(Ne^\alpha)^{++}$ and $11(Ne^\beta)^{++}$ respectively. The other spectra consist of lines already mentioned brought into different positions to increase the convenience and accuracy of comparison and, in addition, there are on C I. two other valuable reference lines, O^{++} apparent mass 8, and on the extreme left just visible C^{++} apparent mass 6.

Method of comparing masses.

It will be noticed that although the lines are broad (the best focus was only obtained by a series of trials after these results were completed) their edges, particularly their left-hand edges, are remarkably sharp, so that measurements of a reasonably good line from the register spot repeat to a twentieth of a millimetre with certainty. Hence for accurate determination of unknown lines only two assumptions need be made. Firstly, that the masses of the reference lines are known, and secondly that, whatever the function connecting displacement with mass, any two positions on the spectrum being taken, the *ratio* of any two masses giving lines in these positions will be constant. This being so, by moving a group of reference lines into overlapping positions along the spectrum it is clear that the whole length can be plotted out and calibrated.

Fortunately there is an easy method of testing both these assumptions, for although it is impossible to measure the magnetic field to one-tenth per cent., it can be kept constant to that accuracy while the electric field is altered by a known ratio. But, for constant deflexions, $mv^2 \propto X$ and $mv \propto H = \text{const.}$ Therefore $m \propto X^{-1}$, so that, to take a

typical case, the position occupied by carbon with a field of 320 volts should be exactly coincident with the position occupied by oxygen with 240 volts when the magnetic field is constant. Over the range of fields used in the case of neon, all such coincidences when expected have been found to occur within the error of experiment whatever the position on the plate.

For some reason, by no means obvious, connected with the geometry of the apparatus the relation between displacement and mass is very nearly linear, a fact which lightens the labour and increases the accuracy of calibration very considerably.

Numerical results.

In the case of plate B the masses of the neon lines were estimated by carefully drawing the calibration curve representing the relation between displacement and mass by means of the known lines 12, 13, 14, 15, 16 checked by that at 28.

With plate D another mode of procedure was adopted. A linear relation was assumed and a table of corrections made by means of reference lines, which correction when subtracted from the observed displacement gave an exactly linear relation with mass. A correction-curve (apparently parabolic) was drawn, from which the appropriate corrections for any displacements could be written down and the masses corresponding to those displacements obtained by simple proportion. The following table gives the results:—

TABLE II.

Plate B.			
(Ne ^α) ⁺⁺ .	(Ne ^β) ⁺⁺ .	(Ne ^α) ⁺ .	(Ne ^β) ⁺ .
9.98	11.00	20.00	20.00
10.02	10.99	19.95	22.01
<hr/>	<hr/>	<hr/>	<hr/>
10.00	10.99(5)	19.97(5)	22.00(5)
Plate D.			
10.01	11.06	20.00	21.90
9.98	10.98	19.98	22.10
9.98	11.01	20.00	22.03
—	—	19.90	21.98
<hr/>	<hr/>	<hr/>	<hr/>
9.99	11.01	19.97	22.00(5)

The method of measurement combined with a slight halation of the plate tends to make the edge of bright lines appear a little too near the register spot. This is enough to account for the reading of the very bright Ne⁺ line giving a

mass a little too low. The above figures therefore can be accepted as fairly conclusive evidence that Atmospheric Neon contains two isotopes of atomic weights 20.00 and 22.00 respectively to an accuracy of about one-tenth per cent.

In order to give the accepted density the quantities required are 90 per cent. and 10 per cent., which is in good agreement with the estimated intensity of the lines.

Possibility of a Third Isotope.

On the clearest spectra obtained with neon there are distinct indications of a line corresponding to an isotope of mass 21. This line is extremely faint, so that if this constituent exists its proportion would be very small, probably well under 1 per cent., and it would not affect the density appreciably. Attempts to bring this line out more distinctly by longer exposures have not succeeded owing to the fogging from the strong neighbouring lines, but it is intended to return to this point when further improvements of the method give hope of more conclusive results. This matter is interesting in connexion with the suggestion by Emerson Reynolds already quoted*.

In conclusion the author wishes to express his thanks to M. Georges Claude, who kindly supplied the neon used, and also to the Government Grant Committee for some of the apparatus employed.

Summary.

A brief account is given of facts which lead to the idea that atmospheric neon may be a mixture of isotopes.

The results of attempts of separation are summarized.

The several lines of evidence adduced from the parabolas obtained by Thomson's method of Positive Ray analysis are considered and shown to be consistent with the above theory but hardly conclusive.

Mass-spectra obtained by means of the Positive Ray Spectrograph are produced. Measurements from these are given which prove conclusively that neon contains two isotopes having atomic weights 20.00 and 22.00 respectively to an accuracy of about one-tenth per cent., their proportions being therefore 90 per cent. and 10 per cent. by volume.

The possibility of a third constituent is indicated.

Cavendish Laboratory,
December 1919.

* Though at the time this was made isotopes were not thought of, and the modern idea of atomic members has since precluded the possibility of three distinct elements.

XLV. *Intelligence and Miscellaneous Articles.*

ON THE EQUATION OF STATE.

To the Editors of the Philosophical Magazine.

SIRS,—

IN a paper published in the 'Philosophical Magazine' for August 1918 it has been shown that from Boltzmann's theory of entropy we can arrive at an equation of state

$$p = -\frac{R\theta}{2b} \log 1 - \frac{2b}{V} = e^{-\frac{a}{NK\theta v}} \dots \dots \dots (1)$$

Amongst other applications of this theorem it was shown that the value of the critical constant $K = \frac{R\theta_c}{p_c V_c}$ would be $\frac{2e}{e-1} = 3.53$, instead of van der Waals' $\frac{8}{3}$ and Dieterici's $\frac{e^2}{2} = 3.69$.

A table was given showing that in the case of the most of the elementary gases the value 3.53 corresponded better with experimental results than either $\frac{8}{3}$ or 3.69.

The list comprised He, N₂, O₂, Xe, but not Hydrogen, about which the experimental data were not satisfactory.

Recently the critical data for Hydrogen have been re-determined in the Laboratory of Prof. K. Onnes (*vide Proc. K. Akad. Wetenschappen, Amsterdam, vol. xx. 1917*).

It has been found that

$$\theta_c = 33^{\circ}18K, d_c = .0310, p_c = 12.8 \text{ atmospheres ;}$$

from these data,

$$K = 3.35.$$

It is superfluous to add that this value of K is in much better agreement with the value 3.53 than with either the value $\frac{8}{3} = 2.66$ or $\frac{e^2}{2} = 3.69$, thus corroborating the belief expressed in the aforesaid paper that the equation (1), though not final, marks a step in the right direction.

University College of Science,
Calcutta, India.

MEGH NAD SAHA.
SATYENDRA NATH BASU.

THE
LONDON, EDINBURGH, AND DUBLIN
PHILOSOPHICAL MAGAZINE
AND
JOURNAL OF SCIENCE.

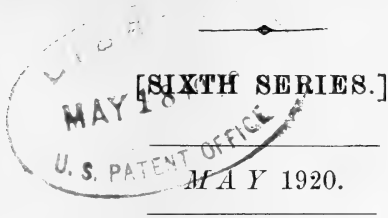

XLVI. *The Spectrum of Copper.*
By W. M. HICKS, F.R.S.*

IN the following pages similar methods are applied to the discussion of the copper spectrum as have already been successful in dealing with those of silver and gold †. The arc spectrum of copper differs from those of the other metals of the group in that it is very rich in lines. It is, however, similar to them in general plan, and the similar conclusions arrived at in each receive greater support in combination.

Strong well defined sets are given for the orders $m=2, 3$ in both the S and D sets and for the first order of P. Those for S(2) are in the red and in step with those for silver. The others show the Zeeman patterns proper for their respective types. These may therefore be adopted definitely as normal series lines. For the higher orders, however, the intensities fall off more quickly and irregularly than usual and there is also evidence, as will be shown below, for numerous displacements. In fact these are apparently the cause of the low intensities and the large number of weak lines. In consequence the determination of the S and D limits with any exactness from the series lines alone is rendered impossible. The doublet separations of the S(2) and D(2) sets are the same within at least $\cdot 01$. For S(2)

* Communicated by the Author.

† Phil. Mag. Sept. 1919—July 1919.

the measures of Meggers* and Meissner† give 248·43, Eder and Valenta 248·42, whilst Meggers' estimates for his probable errors for the two lines give for dn ·03 and ·01, probably less on a difference. The separation for D(2) as calculated below from Fabry and Perot's interferometer measures of D_{11} , D_{22} is 248·44. The separations for the S and D doublets therefore agree within one unit in the second decimal. Now a δ displacement on the limit alters the separation by ·06 and the limit itself by 4·94. Consequently the two limits $S(\infty)$, $D(\infty)$ cannot possibly differ by more than a shift due to one own, *i. e.* by 1·2, and are practically, if not absolutely the same. If, however, the observed sets for $m=4$ as shown in Tables I., II. be taken as normal, the limits as calculated from the first three lines are $S_1(\infty)=31536\cdot29\pm 2$ and $D_1(\infty)=31515\cdot48\pm 10$, and they cannot be the same. At least one set of the fourth order must be abnormal. In the case of $S_1(4)$, Kayser and Runge and Eder and Valenta (spark) agree and Crew and Tatnall give $d\lambda=0\cdot02$, whilst in $S_2(4)$, C. T. give $d\lambda=0\cdot04$ on K. R. and E. V. have not observed it. We may be justified therefore in taking observation errors as small. The observed separation (K. R.) of 248·71 is thus abnormal. It is ·27 too large by K. R. and ·13 by C. T. ‡ The observations are sufficiently exact to prove that a negative displacement has taken place, but not so exact as to determine how much. If the displacement be $-x\delta$, $x=1$ or possibly 2, ν is increased by $0\cdot06x$ and the limit by $4\cdot94x$. In other words the observed lines must be regarded as being affected by a limit $4\cdot94x$ larger than the others. Treated in this way the true limit $S_1(\infty)$ calculated from $m=2, 3, 4$ becomes $31536\cdot29 - 12\cdot46x\pm 2$. The data for the D give a wide margin of variability for $D(\infty)$, chiefly due to uncertainty in $D_1(4)$. K. R.'s measures give $n=27103\cdot00$, C. T.'s 27104·62 with separation 252·14 instead of a value less than 248·44. Also E. V. give a spark line $n=27109\cdot23$ which gives a separation of 245·66 with $D_{22}(4)$, or a satellite separation of 2·78. The data are too uncertain to secure a closer value to the true value of $D(\infty)$. It remains to see what evidence can be obtained from summation lines.

The material from the summation lines is given in Tables I., II. The S give direct indications from $S_1(2)$, $S_2(3)$, $S_2(4)$ for a limit $31523\cdot47\pm 2\cdot5$; .. $23\cdot48\pm 7$; .. $24\cdot82\pm 1\cdot6$ and from the $S_1(4)$ of .. $28\cdot35\pm 1\cdot5$. But we have already seen that

* Bureau of Standards, Washington, No. 312 (1918).

† *Ann. d. Phys.* 50. p. 713 (1916).

‡ But Hasbach gives $\nu=248\cdot42$.

the $S_1(4)$ has a limit $4.94x$ larger than the others. If therefore 37169 is the true summation line for observed $S_1(4)$, its limit should also be $4.94x$ larger. This is clearly indicated with $x=1$ making the normal $S_1(\infty) = 31523.41$. This is a remarkable agreement supporting the previous reasoning of $S_1(\infty) = 31536.29 - 12.46x \pm 2 = 31523.83 \pm 2$ with $x = 1$. The set $S_2(4)$, $S_3(4)$ give an intermediate limit which, however, is explained by taking 37410 as the normal $S_2(4)$, not displaced as is the $S_2(4)$. The mean would therefore be $\frac{1}{2} \times 4.94 = 2.47$ greater than the true, or $S_2(\infty) = 31770.79 \pm 1.7$ giving $S_1(\infty) = 31522.35 \pm 1.7$, the same as the others within error limits. There appears no $S_2(2)$ but a line observed by McLennan $\lambda = 1925$ or $n = 51931.8 \pm 13$ in which all values within ± 13 are equally probable is linked to it. In fact $e.51931.8 \pm 13 = 50932.0 \pm 13$ as $S_2(2)$ gives $S_2(\infty) = 31766.68 \pm 6.5 = 31771.92$ so far as the wave length is known. The evidence from the combined difference and summation lines, considering normal lines alone, is thus quite decisive in making $S_1(\infty)$ quite close to 31523.48.

The D material is not so definite although it supports this value. The sets under $D_{11}(3)$, $D_{22}(3)$ give 31524.17 ± 1 ; $\dots 21.56 \pm 3.4$. Also the doubtful $D_{11}(5)$ is related to a $D_{11}(5)$ which gives $D_1(\infty) = 31522.39 \pm .8$. But in $m=2$ the lines $\lambda\lambda 2276, 2263$ as the summation D_{11}, D_{22} in the table give $D_1(\infty) = 31537.59 \pm .5$. There is however a set connected by the u -link to D_{12}, D_{22} which agrees with the others. The general agreement in favour of $S_1(\infty) = 31523$ shows that the lines $\lambda\lambda = 2276, 2263$ cannot be the D(2) set. Their separation as a D_{11}, D_{22} set should be $248.44 + 6.60 = 255.04$. It is 254.13 ± 2 as observed. If they represent $(-5\frac{3}{4}\delta)D$, the separation should be $5\frac{3}{4} \times .06 = .35$ larger or 255.39 which the observation errors allow, and the normal D set be $5\frac{3}{4} \times 4.94 = 28.41$ less for D_{11} and $5\frac{3}{4} \times 4.99 = 28.70$ less for D_{22} . The means then become 14.20 and 14.35 less or $31523.39, 31771.31$ agreeing with the others. They may therefore be this displaced set, but they must not be used for deducing the limit.

The result is that the limit is within a few decimals of 31523.4. The closest limits of variation are those given by $m=3$, viz. $S_1(\infty) = 31523.48$ in which the possible error is $\pm .7$ but the actual error, judging from the combined results, is probably much less and about .02. The same value is also given by certain $p(1) - f, p(1) + f$ combinations considered below (p. 465). For one of these sets $-f(4)$ —the observation errors are small and give $S_1(\infty) = 31523.475$. In taking then the limit as $31523.48 + \xi$ the value of ξ will not be more than a few decimals. Using this as limit and the accurate

values for $m=2, 3$, the formulæ for S_1 and D_{11} are

$$S \quad 31523 \cdot 48 - N \left/ \left\{ m + \cdot 431291 - \frac{\cdot 078858}{m} \right\}^2, \right.$$

$$D \quad 31523 \cdot 48 - N \left/ \left\{ m + \cdot 989023 - \frac{\cdot 021773}{m} \right\}^2, \right.$$

or if the order in S be taken as $m - \frac{1}{2}$,

$$S = 31523 \cdot 48 - N \left/ \left\{ m - \cdot 5 + \cdot 924719 - \frac{\cdot 049286}{m - \cdot 5} \right\}^2. \right.$$

The calculated $S_1(5) = 27783 \cdot 86$ is sustained by two linked lines, viz.

$$\begin{aligned} u \cdot (6n) 3512 \cdot 19 &= 28464 \cdot 24 - 680 \cdot 68 = 27783 \cdot 56, \\ (2n) 3688 \cdot 60 \cdot u &= 27102 \cdot 99 + 680 \cdot 68 = 27783 \cdot 67. \end{aligned}$$

The latter is the line allocated by K. R. to $D_{11}(4)$ which we have seen cannot be correct. The calculated value for $D_{11}(4)$ is $n = 27107 \cdot 52$. An arc line by C. T. at $n = 27104 \cdot 60$ would be $(2 \delta_1) D_{11}$, also by C. T. at $n = 27117 \cdot 17$ is $9 \cdot 63$ ahead and as 2δ shifts $9 \cdot 88$ it would be $(-2 \delta) D_{11}$. These are therefore possibilities. Hasbach gives $\lambda = 3687 \cdot 5$ I. A. or $n = 27110 \cdot 17 - 7 \cdot 3 d\lambda$ R.A. His excitation may have produced the normal set.

The P series.—There is a clear set for $P(1)$, strong, with the normal separation, showing reversals, and the Zeeman patterns belonging to P_1, P_2 . With the value of $S_1(\infty)$ just obtained the limit $P(\infty)$ is known with the same exactness. But although the observed region should include several succeeding orders it is difficult to allocate them with certainty. There is a large number of weak lines where $P(2)$ should occur. Like the S and D series the P series appear as if frayed out and any summation lines lie far down in the ultra-violet beyond any observed region. There is a line at $49363 \cdot 70 \pm 4 \cdot 9$ ($\lambda = 2025$) showing reversal and in about the proper position for $P_1(2)$. $P_2(2)$ should be about 60 above it, but there is no trace of it. It gives for the combination $p_1(1) - p_1(2)$, $n = 18580 \cdot 93 \pm 4 \cdot 9$ which may be the observed spark line (E. V.) (3) 18579 \cdot 61. Another spark line at $n = (3) 18772 \cdot 87$ might correspond to $p_2(1) - p_2(2)$ giving the separation of the $P(2)$ lines as $55 \cdot 10$, in order but rather small. The formula calculated from this line as $P_1(2)$ with $P(1)$ and the known limit gives lines for succeeding orders which have not been observed, nor does the calculated sequence for $P(3)$ give any $p(1) - p(3)$ combinations. If, however, the weak line $n = (1) 49069 \cdot 64 \pm 2 \cdot 4$ be taken as $P_1(2)$ with $P_2(2)$ not observed, the resulting formula gives

lines for $m=3 \dots 6$ whose wave numbers are 55031.92 ± 1.30 , $57710.49 \pm .75$, $59141.05 \pm .5$, 59994.15 in which the ambiguities are due to possible errors in $P_1(2)$. These all lie in the ultra-violet region of Handke. In comparing observed with calculated it should be remembered that Handke gives his measures to $.1 \text{ \AA}$., whilst dn varies from $28 d\lambda$ to $40 d\lambda$. Consequently any value of $d\lambda$ between $\pm .05$ is equally probable or of dn between limits varying from 1.4 to 2 . In addition are observation and standard errors of which no estimates are given. The formula for P_1 is

$$n = 62306.25 - N \left\{ m + .891742 - \frac{.026494}{m} \right\}^2.$$

$m=2$. 49069 . This gives $p_1(1) - p_1(2) = 18286.87 \pm 2.4$. This is not observed, but an observed line $n = (2n) 18475.93$ treated as $p_2(1) - p_2(2)$ gives the $P(2)$ separation as $59.38 \pm$, the expected amount.

$m=3$. [55031.92 ± 1.30]. There is an observed line at (1) $55026.69 - 30 d\lambda$. Also (2n) $24245.24 (6)$ as $p_1(1) - p_1(3)$ gives $P_1(3) = 55028.01 \pm .6$.

$m=4$. [$57710.87 \pm .75$]. There is an observed line at (4) $57723.4 - 33 d\lambda$.

Also (2n) $26931.74 \pm .3$ as $p_1(1) - p_1(4)$ gives

$$P_1(4) = 57714.51 \pm .3.$$

(2n) 27188.69 as $p_2(1) - p_2(4)$ gives

$$P_2(4) = 57723.23 \pm .4.$$

The former supports the calculated $P_1(4)$. The second is the observed, but it is curious that P_2 should be seen and P_1 absent.

$m=5$. [$59141.05 \pm .5$]. This is not observed, but it is connected by u -links to lines on both sides. Thus

$$u. (8) 59822.9 = 59142.24 - 36 d\lambda,$$

$$(6) 58459.0 .u = 59139.70 - 34 d\lambda,$$

an exact series inequality.

Also (2n) 28366.38 as $p_1(1) - p_1(5)$ gives $P_1(5) = 59149.15 \pm .8$, probably P_2 with no observed P_1 as in the previous order.

$m=6$. [59994.15]. This is not observed, but there are v -linked lines for P_1, P_2 , viz.

$$(6) 59297.9 .v = 59989.9 - 35 d\lambda$$

$$(8) 59290.9 .v = 59982.9 - 35 d\lambda.$$

These would give the $P(6)$ separation as $7 - 35(d\lambda_1 - d\lambda_2) = 7 \pm 3.5$ as against a calculated value of 4 . It thus agrees within equally probable errors.

Also (2n) 29212.61 as $p_1(1) - p_1(6)$ gives $P_1(6) = 59995.38 \pm .8$ —also to the violet of the linked lines.

The next two calculated lines are 60543, 60917. There are strong lines at $60536 - 36.6 d\lambda$ and $60908.7 - 37 d\lambda$, but they are too strong and moreover show evidence of being summation lines (see later, p. 473). The formulæ reproductions combined with the observed combinations would then seem to support the allocations given as at least one of the frayed out fragments of the system. The whole region round the observed combinations is full of lines of the same nature ($2n$) and may possibly be combinations for some of the other P fragments. The combinations considered above are collected in Table III. at the end.

The establishment of the hypothesis of the break-up of a normal series into a large number of displaced, and linked or otherwise shifted lines is of fundamental importance. The laws regulating this break-up can only be discussed when a large mass of material for comparison has been collected. As a contribution to this some instances are considered in an appendix.

Spectral constants.—With the establishment of the S limit as $31523.48 + \xi$ it becomes possible to apply the same methods as were employed in the discussion of the spectra of Ag and Au to determine the value of ν more accurately and to deduce therefrom the value of the own and of the various links. There are no interferential measures giving ν directly but, as in Ag, Au, Fabry and Perot give such for $D_{11}(2)$ and $D_{22}(2)$. K. R.'s values are very accurate and give definitely that $\Delta = 50\delta$ and that the satellite separation for $D(2)$ is due to $23\delta_1$. The separation of D_{11}, D_{22} given by F. P.'s measures, $\lambda\lambda 5153.251 + .001x_1, 5218.202 + .001x_2$ in I.A., is $241.4632 - .00376x_2 + .00367x_1$. The calculation carried out on the same lines as in the case of Ag and Au gives in R.A.

$$\nu = 248.44402 - .0038(x_2 - x_1),$$

$$\Delta = 7307.087 - .3310\xi - .113x_2 + .110x_1,$$

$$\delta = 146.1419 - .00662\xi - .0022y \text{ where } y = x_2 - x_1.$$

From these and $s(1) = 31523.48 + \xi - P_1(1) = 62306.25 + \xi$ the calculated links are

$$a = 245.54$$

$$c = 251.39$$

$$b = 248.44$$

$$d = 254.39$$

$$e = 999.77$$

$$u = 680.68$$

$$v = 692.02.$$

With ambiguities of $\xi = \pm 1$ and y of 1, the spectral

atomic weight of copper in terms of that of Ag comes to $63.5569 \pm .006$. Brauner's value of the chemical atomic weight is $63.56 \pm .01$.

With this approximate value of Δ it is now possible to test for D lines corresponding to the order $m=1$, in which the D satellite sequence or $d_2(1)$ has its mantissa a multiple of Δ . The actual values will depend on the true value of N but the deviation from the truth on this account will not amount to more than 7 or 8 units in the sequent, and will be passed over for the present. The extrapolated mantissa of $d_1(1)$ is 967250. The actual value for $d_2(2)$ is 977297. That of $d_2(1)$ must be less than the latter, and the multiple therefore be in the neighbourhood of 132. Any evidence of the real existence of D(1) lines must be based on combination lines with the inverse D' set, and on the presence of summation lines. It may be said at once that no such evidence can be found for 131 Δ . With the values above $132\Delta = 964535 - 43.6\xi - 14y$. The $d_2(1)$ is $N/(1 + 132\Delta)^2 = 28417.66 + 1.26\xi + .41y$. Consequently

$$D_{12}(1) = 3105.82 - .26\xi,$$

$$D_{12}(1) = 59941.14 + 2.26\xi.$$

There is a line at $(1)59916.12 - 36d\lambda$ of Handke's but no other in this region. If it is the surviving strongest D_{11} line the D set should be

$$D_{12} = 59941.14 + 2.26\xi,$$

$$D_{11} = 59916.12 - 36d\lambda,$$

$$D_{22} = 60189.62 + 2.26\xi.$$

ξ is probably not greater than a few decimals so that the satellite separation is $\sigma = 25 + 36d\lambda$, but this may be modified up to ± 7 by the unknown error in N. As it stands however, the separation of 25 would be due to $24\delta_1 = 6\delta$, as usual slightly larger than for the $m=2$ set ($23\delta_1$).

The inverse D' lines are in wave numbers in R.A.

$$D_{12}' = -(8)17537.66,$$

$$D_{11}' = -(1)17439.40,$$

$$D_{22}' = -(8)17289.22.$$

It should be noted that the D_{11} line instead of being the strongest of the set is extremely weak, and seems to indicate that very few of the d_2 configurations have split up to form

those giving d_1 . The calculated and observed combinations then give

	Calc.	Obs.
$d_2'(1) - d_2(1) = 20643.48$	}	(1) 20640.47 Exner and Haschek
		(1n) 20639.69 Hasbach
$d_1'(1) - d_2(1) = 20545.22$		(2n) 20543.50 \pm .85.

There is also a line by E.H. (2) 20574.25 \pm .85 which if it is the combination $d_1'(1) - d_1(1)$ gives $\sigma = 30.75$.

With 133 Δ ,

$$\begin{aligned} d_2(1) &= 28207.43 + 1.25\xi, \\ D_{12}(1) &= 3316.05 - .25\xi \\ D_{12}(1) &= 59730.91 + 2.25\xi. \end{aligned}$$

There is a line (7) 59719.32 - 35.6 $d\lambda$ which would serve as a D_{11} giving $\sigma = 11.6 + 35d\lambda$. It is so strong that we should expect that at least D_{22} should be visible, but there is nothing which can possibly stand for it. The combinations are

	Calc.	Obs.
$d_2'(1) - d_2(1) = 20853.94$	}	(2n) 20852.66,
$d_1'(1) - d_2(1) = 20755.61$		none ;

and again 20767.6 (a spark line observed by Hemsalech) can serve as $d_1'(1) - d_1(1)$ giving $\sigma = 12$, or the same as by the direct summation lines. Little weight perhaps should be given to this case, but so far as it goes it points to a second system of D series.

That part of Handke's observations which lies beyond $\lambda = 1770$ shows clear evidence of connexion as summation lines with D(1) sets, depending not only on different d_2 sequences, but on displaced d sequences and displaced D(∞) limits—a short discussion of them is given in the Appendix.

The F series.—So long as D(2) was believed to be the first set in the D series it was natural to attempt to allocate F series with limits = $d_1(2)$, $d_2(2)$, with therefore a separation of 6.98. No such doublet series were found. Nevertheless Randall proved the existence of certain sequents with all the appearance of belonging to the F type. The proof depended on the existence of lines satisfying the conditions for combinations $p(1) - f(m)$ $d'(1) - f(m)$ and one doublet set $d(2) - f(3)$ far up in the ultra-red but with a separation 10.5 instead of 7, thereby indicating a satellite effect in the f sequence. We will consider

these, with extensions, before proceeding to the discussion of the true F series $d(1)-f(m)$. It may be noted in passing that the existence of the D(1) set explains why no F set was found on the old supposition, as only a few lines of the combination $d(2)-f(m)$ would be strong enough to appear. The material is given in Tables V-VII. We will now discuss them in order, beginning with Randall's allocations for $m=3$. The data for the constant sequents are

$$p_1(1) = 31523.48, \quad d_1'(1) = 48962.91, \quad d_1(2) = 12365.67.$$

$$p_2(1) = 31771.92, \quad d_2'(1) = 49061.37, \quad d_2(2) = 12372.65.$$

$$m=3. \text{ The } p-f \text{ (Table VII.) give } \begin{array}{l} f_1(3) = 6880.31 \\ f_2(3) = 6877.16. \end{array}$$

$$,, \quad d(2)-f \text{ (Table VI.) } ,, \quad \begin{array}{l} f_1(3) = 6880.06 \\ f_2(3) = 6876.52. \end{array}$$

$$,, \quad d_2'(1)-f \quad ,, \quad f(3) = 6880.12.$$

The agreement amongst the sets renders the allocations practically certain. But it may be noted as exceptional that the f_2 sequent is less than the f_1 —i. e., it is a positive displacement on f_1 contrary to the universal rule in d satellites though not unknown in f . Further, in the $d_2'-f$ we should expect f_2 and not f_1 as here. It is natural to suppose that there is no f satellite and that the $d_2(2)$ receives an extra displacement instead of f , but this is negatived by the fact that f_2 occurs also in the $p-f$ line where this explanation is excluded. The appearance of the f_1 in the d_2' may be due to the fact that in copper the D_{11} line is scarcely formed and that its place is taken by the undisplaced D_{12} . On this supposition we should expect a double line $d_n=3.2$ or $d\lambda=.2$.

Lines are also found corresponding to p_2+f_2 and $d_2'+f_1$. The first, a spark line, gives $f_2(3)=6876.08$; the latter $f_1=6885.8-31d\lambda$.

The separation of $f_1(3), f_2(3)$ appears as 3.54, 3.15, but the measures are not very exact. A displacement of $6\frac{1}{2}\delta$ gives a separation 3.14.

$m=4$. The $p-f$ are displaced by the electric field and strengthened by it, as is the rule with this type of combination. Stark's measures for zero field are used. These give $f_1(4)=4402.00, f_2(4)=4399.56$. The summation gives $f_1(4)=4402.00, f_2(4)=4399.68$. The difference and summation thus agree with great exactness. They give as the mean for $p_1(1), 31523.475$, thus closely supporting the

already obtained value. We may therefore regard the ξ as probably $< .02$. The $d_2' - f$ gives $f(4) = 4402.56 \pm 1$, that is as in $m=3$ it gives f_1 . The lines 44576 and 53446 may be put in evidence because they appear to satisfy a set $d_1' - X$, $d_2' + X$. $d_2' - X$ would be 98.46 larger and = 44674.46. This with the second as $d_2' + X$ gives $d_2' = 49060.56$, $X = 4386.1$, or a corresponding set with a large sequent displacement as in $f(3)$.

$m=5$. Only the $p - f$ combinations are observed. They are the same as for $D(5)$, i. e. $f(5) = d(5)$, and give $f_1(5) = 3059.20 \pm .4$, $f_2(5) = 3057.10 \pm 1.2$. The $d' + f$ is in an observational lacuna and no $d' - f$ is seen.

$m=6$. The $p_1 f_1$ give $f_1 = 2235.50$ and 2236.35 with mean limit 31523.85 . Nevertheless there may be some doubt as to their belonging to this system since their mantissæ as given below are not in step with the others. Also the $p + f$ line is excessively strong. If this $f(6)$ is -2Δ displacement on the normal it would be more in line. The line under $p_2 - f$ is also probably not the real line. It is 1.56 too small and moreover is the exact linked line $e.P_2(1).46800$ as $d_2' - f$ gives $f(6) = 2261.22$ and 46834 gives $f = 2227.44$. These look like equal and opposite displacements of $7\delta_1$ in the limit. Their difference is 33.78 and $14\delta_1$ shifts 33.58 . This would give $f_1(6) = 2244.33$ whose mantissa 992044 is quite in step with the other orders.

$m=7$. $d' - f$ gives $f(7) = 1733.70$. It is not in step with the normal f . If it is analogous to the second in $m=6$, i. e. $(7\delta_1)d_2' - f$, then $f = 1715.9$ and comes into line with the others.

An attempt may now be made to determine the values of $f(1, 2)$. The run of the mantissæ of the higher orders as seen below shows that the denominators of these sequents must be near 1.992 and 2.992. Moreover we have to expect satellites depending on displacements of about $6\frac{1}{4}\delta$, which as has been seen is that for $f(3)$. This means for $m=2$, $f(2)$ about 12250 and satellite separation 7, and for $m=1$, $f(1)$ about 27450 and satellite separation 25. The fact that the lower orders of F series are very susceptible to displacement and consequent weakening must also be borne in mind. Several representative sets corresponding to the same order m may therefore be expected, and the allocation of a suitable set does not mean that it must be the normal one.

$m=2$. The $p.f$ give $f_1(2)=12257.10$, $f_2(2)=12246.01$ with satellite separation 11.09. In the $d.f$ there now appears a representative of $d_1'-f_1$. They give $f_1(2)=12264.15(1.34)$ and $f_2(2)=12249.53(1.34)$. The denominator of 12257.19 is 2.991400, that of 12249.45 is 2.992313, which differ by $6\frac{1}{4}\delta$. Also 12257.10 and 12264.15 differ by the same within limits. We are here clearly in the presence of successive satellite displacements.

It may be noted that again the $p.f$ and $d.f$ combinations both give $f_2 < f_1$ in agreement with the higher orders and in opposition to what is apparently the normal rule.

The mantissæ are of the same order of magnitude as those of higher orders. Generally they increase as the order decreases. It is probable therefore that the lines indicated are not the normal ones, but may be displaced representatives.

There are in fact several sets of lines in this neighbourhood suggesting p,f combinations. The whole deserves a more exhaustive discussion.

The $d(2)-f(2)$ would lie far in the ultra-red above Randall's longest wave-lengths.

$m=1$. The $p-f$ would be above Randall's longest. The p_1+f_1 gives $f_1=27445.74-35d\lambda$. The $d_1(2)-f_1$, $d_1(2)-f_2$ give $f_1=27445.36$, $f_2=27470.52$, whilst of the summation lines suggested the first as d_1+f_1 gives $f_2(1)=27448.00$ and the second as d_2+f_2 gives $f_2(1)=27477.00$ and probably do not belong to the same system. If the $d(2)-f$ allocations are correct the numerical values of f deduced are very exact. The satellite separation $\sigma=25.07$ requires a change in mantissæ of 913 and $6\frac{1}{4}\delta=913$. Thus we find the $6\frac{1}{4}\delta$ of the higher orders exactly reproduced. There are however a large number of lines, especially in the spark, in this neighbourhood which may correspond to series depending on different $d(2)$ and $f(1)$ and they should repay further consideration. As an example, may be taken the set

$$d_1(2) - f_1(1) = -(5rv) 14983.35 :$$

$$d_1(2) + f_1(1) = (2) 39718.36 s$$

$$d_2(2) + f_2(1) = (1) 39751.63 s$$

$$(\lambda\lambda = 6672.234 \text{ I.A. Aretz. } 2517.03, 2514.87 \text{ E.V.})$$

which give $f_1(1)=27349.31$, 27352.40 , $f_2(1)=27378.98$ with $\sigma=26.48$. If the last is d_1+f_2 , $f_2=27385.67$.

The values of the f sequence as found above are here collected, together with the values of their denominators.

f .		f .		
$m=1$	27385·67	2·001208	$m=4$, 4402·00	4·991473
	27349·31	2·002537	$m=5$, 3058·3	5·988440
	27445·36	1·999030	$m=6$, 2244·33	6·992044
$m=2$	12257·10	2·991400	$m=7$, 1715·9	7·994780
	12249·48	2·992313		
$m=3$	6880·35	3·992533		
	6877·20	3·993446		

The real F series depends on limits $d_1(1)$, $d_2(1)$, and if the f sequence is the same as in the above we ought to be able to find them. There are several possible values of the $d(1)$ as we have already seen, the most stable apparently being that based on 132Δ . It gives $d_2(1) = 28417·66 + x$, x being a small uncertainty due to inexact N. The F(1) lines will be in the neighbourhood of $n=1000$, and beyond the observed region. There is a line at $n = (3)55800·5 - 30d\lambda$, about the position to be expected for a F(1) line, and as it occurs by itself we should expect it to be $F_{11} = d_1(1) + f_1(1)$. But we have seen the most probable satellite separations are about 25 in both sequences, but opposite, so that $d_1 = d_2 - 25$ and $f_1 = f_2 + 25$. The lines $d_1 + f_1$ and $d_2 + f_2$ would therefore be almost coincident. Hence $f_2(1) = 55800·5 - 30d\lambda - 28417·66 - x = 27383·8 - 30d\lambda - x$, which recalls the value obtained from the second $d(2) + f$ lines adduced under $m=1$ above. We shall see reason below to put $F_2(\infty) = d_2(1) = 28410·26$ or $x = -7·4$ about. This makes $f_2(1) = 27391 - 30d\lambda$. In the table above the mantissa of 27385·67 is given as 1001208, and this is $137 \times 7308·919$, very close therefore to 137Δ . It suggests therefore that 55800 is $N/(1 + 132\Delta)^2 + N/(1 + 137\Delta)^2$ and thus the normal $F_2(1)$ line. Its discussion is deferred for fuller treatment of the general theory.

$m=2$. With $d_1(1) = 28410·26$ and satellite displacement 6δ $d_1(1)$ or $F_1(\infty)$ is 25·37 less, = 28384·89 \pm . With 16126·12 as F_{11} this gives $f_1 = 12258·77$. F_{22} gives $f_2 = 12245·10$.

$m=3$. This set is important as with the known $f_1(3) = 6880·34$ and $f_2(3) = 6877·16$ the limits $F_1(\infty)$ and $F_2(\infty)$ come out to 28382·96 and 28410·04. The latter should be correct within a few decimals, but the $F_1(\infty)$ depends on a doubtful spark line ($\lambda = 4177·87$).

$m=4$. The whole region for F is clear of lines except $(4n)23929·06$. This is 51·90 behind the calculated. If it

be regarded as a displaced limit of $12\frac{1}{4}\delta$ (producing 51.80) we find a corresponding F at $(1n)32739.77$ ($\lambda=3053.52$). The two give a mean limit of 28334.41. The shift 51.80 would then indicate $F_1(\infty)=28386.21$.

$m=5$. The line 25328.06 with $f_1(5)=3059.2$ gives $F_1(\infty)=28387.26$ or with the $F_1(\infty)=28382.96$ of $m=3$ gives $f_1(5)=3054.90$. This has a mantissa 991768 and much more in line with the others than 5059.

$m=6$. $F_1(6)$ should be close to $S_2(4)=26135.66$. That in the table as $F_2(6)$ gives $f_2=2246.43$.

$m=7$. The F_2 gives $f_2=1719.16$, with denominator 7.990 much more in step than the 1715.9 determined from the very uncertain data of $d'-f$ above. The f_1 should be practically equal to f_2 . In this case the $F_1(7)$ would require $F_1(\infty)=28385.10$.

$m=8$. The F_2 gives $f_2=1357.28$ (mant. = .990). The same value for f_1 in F_1 requires $F_1(\infty)=28382.70$.

$m=9$. With a mantissa 990 for f_1 , it is 1099.6 requiring $F_1 \infty = 28383.0$.

$m=10$. The lines given in the table cannot be a normal F set because they require a f sequent = 889.87. This has a denominator 11.101. The calculated value for F_2 with denominator 10.990 is 27502.21. The normal set are thus 18.18 less than the observed. As $4\frac{1}{4}\delta$ on the limit shifts it through 18.03, the observed will be $(-4\frac{1}{4}\delta) F(10)$ numerically if not in reality.

The combined discussion gives $F_1(\infty)$, $F_2(\infty)$ as very close to 28382.9, 28410.0.

The inverse D of Cu, Ag, Au.—The inverse D set seem to stand by themselves, but they form a characteristic feature in all the elements of this group. For this reason it is desirable to consider them together in a comparative study. The lines are, in wave numbers (R.A.) :

	Cu.		Ag.		An.	
D_{22} .	(8) 17289.22	} 248.44	(4r) 18206.55	} 920.59	(4) 15923.38	} 3815.54
D_{11} .	(1) 17439.40		(2r) 18744.15		(4) 19113.51	
D_{12} .	(8) 17537.66		(1r) 18947.14		(2) 19738.92	

The Cu measures above are deduced from Hasbach's observations, who gives the same satellite separation as Aretz. This separation cannot be in error by more than .1. The Ag numbers are from Kayser and Runge, as Kaspar's are clearly in error giving a doublet $\nu=919.87$; the gold also

by K.R. The Zeeman effects have been observed for Cu D_{12} , D_{22} by Runge and Paschen and for Au D_{11} , D_{22} by Hartmann, and agree with those for the given allocations.

The satellite separations must depend on displacements in the sequent of a multiple of δ . The observed separations cannot be in error by as much as $d\delta = \cdot 1$. The denominators of the sequents, calculated from the limits $D(\infty)$ as determined above and in previous papers in this journal (30642·60 for Ag, 29469·85 for Au) are :

	Cu.	Ag.	Au.
d_1	1·496751	1·490214	1·502485
	1500	3053	9578
d_2	1·495251	1·487161	1·492907

These differences can only be subject to uncertainties not greater than 2 or 3 units, due to error observations, calculation errors of $\cdot 5$ with possibility of 1 on a difference, and a small error in the limits. Now with no uncertainties we find

Cu.	Ag.	Au.
$10\frac{1}{4}\delta = 1497\cdot 9$	$7\frac{1}{4}\delta = 3052\cdot 4$	$6\frac{3}{4}\delta = 9495\cdot 9$

There is thus perfect agreement within these extremely narrow variation limits for copper and silver, but for gold there is definitely no multiple relation. At the same time the relation is found to hold so universally that there must be some reason for the deviation here. The most natural place to seek it is a change in the other sequent, viz. $D(\infty)$, and we find that a displacement of -2δ in this, completely explains the deviation—numerically at least. The δ displacement on $D(\infty)$ alters the limit by 2·69. Hence $-2\delta_1$ increases it by 5·38. The d_1 sequent calculated from this must therefore be increased by the same amount, and the denominator is then found to be 1·502402, thus altering the mantissa difference to 9495 or the exact $6\frac{3}{4}\delta = 9495\cdot 9$. It may be noted that the D_{11} line only appears to take its normal relative intensity in gold. It suggests the possibility that similar displacements are the normal rule. It would explain certain other anomalies between F separations and d satellites, as for instance the anomalous f satellites referred to above ($m=6, 7$ on p. 466). Here the observed separation of 625 is not the true sequent separation which is 620·03, and it is the latter which should be expected as the corresponding F doublet separation.

APPENDIX.

I collect here a few examples whose importance lies in the light they are capable of throwing on certain fundamental points in spectral theory. The first illustrates the phenomenon of double displacement. The laws governing this effect are at present quite unknown and their discovery is a matter of the first importance. The discussion is however difficult because mere numerical coincidence between a suggested double displacement and observation has little weight as evidence that the suggestion corresponds to a real connexion. In fact it only has weight if the observed values are exact to within $\delta n = \pm 0.02$, or where the own itself is very large or where there is additional evidence in its favour. In the case here illustrated the last consideration is present. The second is of interest as affording the first example of the discovery of a new series through the summation lines, and also further evidence of the fraying out of the normal P series in copper. The third contains further evidence for multiple D(1) systems or for separate such displaced ones. The fourth will illustrate the existence of the complicated systems in one order of the F series due to linkage and successive displacements in sequents and limits.

(1). In the neighbourhood of S(2) the lines between $\lambda = 8114$ and 7848 may be arranged as follows—in I.A. wave numbers :

S(2).

2) 12320.73(.03)	32.63	(10) 12353.36(.03)	33.18	(2) 12386.54(.05)	133.42	(2) 12486.78(.03)
247.74		248.43		249.10		250.92
2) 12568.47(.03)		(10) 12601.79(.02)		(1) 12635.64(.05)		(1) 12737.70(.05)

together with (2) 12468.84(.03) which is 115.48 ahead of $S_1(2)$. The separations in the top line are given as from $S_1(2)$. They clearly denote systems of doublets which are displaced in some definite way from the normal S(2) lines. They show, as they ought on this supposition, increasing doublet separations with shift towards the violet. Before considering the amounts however it is essential to know the precise limits of error in the measures. They are all by the same observer (Meggers*) in I.A. The number in brackets on the right of each wave number gives the variation δn as calculated from his estimates of probable error $\delta \lambda$. We have to do, however, with

* Bureau of Standards, No. 312 (1918).

differences of wave numbers in the same region of the spectrum, and in this case the probable errors will be far less than those given as all systematic errors will be eliminated. This may be illustrated from the measures for $S(2)$. For $S_1(2)$ E.V. and Meissner both agree in making the wave length $\cdot 04 \text{ \AA}$ larger, whilst in $S_2(2)$ E.V. make it $\cdot 05$ larger and Meissner $\cdot 04$. Thus on differences Meissner agrees exactly with Meggers and E.V. make it only $\cdot 01$ less. The true value based on interferential measures to $\cdot 001$ has been found to be $248\cdot 44$, whilst the observers here relied on only read to $\cdot 01 \text{ \AA}$. We shall be safe therefore in regarding the probable errors in separations as less than $\cdot 03$ for the poorer measures and $\cdot 02$ for the better, or say possible errors not greater than $\cdot 08$ and $\cdot 04$. Any calculated displacement effects must therefore agree with observed within these limits. As we have to deal with differences of numbers of seven digits and 7-fig. logarithms have been used, errors of $\cdot 01$ may be introduced on this account also. The limit $S_1(\infty)$ is $31523\cdot 48 = N/(1\cdot 865248)^2$ and the δ displacement produces a shift of $4\cdot 94$. The sequent $s_1(2) = 31523\cdot 48 - 12352\cdot 95 = N/(2\cdot 391865)$ in R.A., and the δ displacement produces a shift of $2\cdot 34$. Further a δ on $S_1(\infty)$ decreases ν by $\cdot 06$. These will enable a rough estimate to be made for the displacements required, and actual direct calculation in each case will then be necessary to give the exact values.

If we attempt to explain the shifts from the S_1 lines by displacements on the limits alone, we find that $6\frac{1}{2}\delta$ shifts back $32\cdot 04$, $-6\frac{3}{4}\delta$ shifts forward $33\cdot 34$ and -27δ shifts $134\cdot 08$. These are not only far from satisfying our present limits of accuracy, but the changes in ν called forth by them are not sufficient to meet the observed amounts. Displacements on both sequents must therefore take place. We begin by finding the displacements on the limits which will reproduce the observed values of ν . The results are :

Displacement.....	$12\frac{1}{2}\delta$	-11δ	-42δ
$\nu \dots$	247\cdot 74	249\cdot 09	250\cdot 91

But since the δ displacement alters ν by $\cdot 06$, *i. e.* the ν by $\cdot 015$, the actual displacements may differ by one or two ν 's and yet give the values of ν within our error estimates*.

* An illustration of the value of accuracy to $\cdot 001 \text{ \AA}$.

The above displacements respectively shift the limits by $-61\cdot5$, $54\cdot41$, $208\cdot96$. The results are as follows—where the second alternative refer to an additional two oons on the limit:—

	Displ.	ν .	Shift from S_1 .	Obs. shift.
1 a.	$(12\frac{1}{2}\delta)S(12\frac{1}{2}\delta)$	247·74	-32·40	-32·63
1 b.	$(13\delta)S(13\frac{1}{2}\delta)$	247·71	-32·53	
2 a.	$(-11\delta)S(-9\delta)$	249·09	33·29	33·18
2 b.	$(-10\frac{1}{2}\delta)S(-8\delta)$	249·06	33·13	
3 a.	$(-42\delta)S(-32\delta)$	250·91	133·60	133·42
3 b.	$(-41\frac{1}{2}\delta)S(-31\delta)$	250·88	133·47	

In each case the first arrangement reproduces the ν with practical exactness, but the observed are shifted to the red respectively by $\cdot23$, $\cdot11$, $\cdot18$, or 1 b, 2 a, 3 a by the same amount (say $\cdot15$) within error limits. These are greater than the limits of accuracy allow. Either therefore the second sets must be taken as correct, or there is a shift produced by say the electric or pole effect in the arc. Relatively to each other the first set completely satisfy the conditions, and if Meissner's and E.V.'s measures for $S_1(2)$ are taken the whole set including $S(2)$ will fall into line. But it is safer to deal throughout with the same observer. It may be noted that the two displacements in each case have the same sign. The same rule as is already recognized in the double displacement which D_{22} experiences from D_{11} .

(2). In seeking for the high order lines of $P(m)$, lines were found close to the calculated values of $P(7, 8)$. They were however too strong to be identified with the latter. But it was noticed that the separations of 62289, 61451, 60908, 60536 were just those given by Rydberg's tables for denominators 5·91, 6·91, 7·91, 8·91 but in reverse order—that is, they were the higher orders of a summation series. The limit calculated from them was in the neighbourhood of 59150. It was thus easy to search for the corresponding difference series. Such was found, but the means gave a limit 59174·8. The data are collected in Table IV., in which the limits of variation are those of equal probability—*i.e.* due to Handke's measures being only given to $\cdot1$ A. The quite definite allocations are indicated by * ; the others

are given as possibilities to show how the theory of displacement can explain them. The limit found by the high orders 59150 should be expected to deviate by only a few units from the truth and 59174 would seem too large. It is, however, the only value for which a succession of corresponding lines can be found. It could be explained by supposing the summation series to have the limit $59150 \pm$ and the difference series about $59200 \pm$. For the sake of brevity we will refer to the series by the letter Q, but this is not to suggest a new kind of series. It is probably only one of several P series (or possibly F or D). The order of intensities in the Q lines can easily be explained as due to weakening at the red end because of increase of order and an apparent weakening at the other as being close on the limits of Handke's region. But this explanation will not hold for the Q where the order of intensities is quite anomalous. The explanation offered is that the configurations giving lines of lower order are excessively broken up and only a small number subsist to give weak normal lines. This weakening in the low orders points to an F type, rather than P.

For Q(6) no line is observed but the two strong lines shown in the table are numerically $\pm 7\delta$ displacements on the limit and are probably really so. Their separation from their mean is 89.06 and this requires a mantissa difference of 1024 whilst $7\delta = 1024$. The numerical coincidence is thus exact. Again there is no representative for Q(4). The two lines given in the table lie on either side of it and the displacements shown produce a Q_1, Q_2 with separation 14.6 which will go with combination lines as will be shown immediately. Q(3) would lie in the unobserved region between the shortest of K. R. and the longest of Handke. The two strong lines given for Q(2) are certainly of the P type and give the same separations for $m=2$ as in the P series considered above. There is no strong and definite representative for Q(1). All the lines in the region suitable for it are nebulous. We should expect a doublet with separation of the order 248 such that it should be produced by the Δ displacement on $51974.8 - Q(1)$. There are several doublets but none quite satisfactory. For instance, that given in the table for $Q_1(1) - 275.3.46$ —gives $q(1) = 31591.3$ or 63 greater than $p(1)$ and equivalent to $(-13\delta)p(1)$. But this would mean with Δ a separation $248.44 + 13 \times 06 = 249.22$ instead of 245.50 as shown. There are so many possible explanations that nothing is to be gained in

our present state of knowledge in further considering them.

If the doublet be regarded as the true Q(1) we find the following combinations :—

	Calc.		Obs.
$q(1)-q(2)$	18295.68		(4 <i>n</i>) 18298.11
	186.02		186.09
	18481.70		(3 <i>n</i>) 18484.20
$q(1)-q(4)$	27050.8		(2 <i>n</i>) 27052.98
	231.0		230.43
	27281.8		(1 <i>n</i>) 27283.41

but the last two have also been allocated to F₂₂(8), F₁₁(9).

The observed appear displaced to the violet, which may be a pole effect as these $p(1)-p(m)$ combinations appear very susceptible to the electric field.

Q(4) is beyond Handke's region, but sounding with the e link gives the line shown and agrees within limits with Q(4). So again there is no representative of Q(9), but this is probably due to the fact of its high order. The two lines shown in the table are separated by 89 within limits of that of Q(6) and are numerically at least displaced from Q(9) as shown.

Attention should also be drawn to the large number of lines which are separated from these Q lines by amounts which are equivalent to definite δ displacements on the limit. The δ displacement on the limit shifts it by 12.723. Thus there are lines whose separations from the Q are a follows :—

Q(9).	- 77.47	6 δ shifts	76.33
Q(8).	127.29	10 δ "	127.23
	63.58	5 δ "	63.66
Q(7).	112.30	8 $\frac{2}{3} \delta$ "	111.3
	61.0	5 δ "	63.7
	- 44.85	3 $\frac{2}{3} \delta$ "	44.55
	-123.8	9 $\frac{2}{3} \delta$ "	124.02
Q(6).	56818, - 19.36	1 $\frac{1}{2} \delta$ "	19.10
	- 64.70	5 δ "	63.66
	56996, 100.88	8 δ "	101.7
	149.8	11 $\frac{2}{3} \delta$ "	149.5
Q(5).	140	11 δ "	139.92
	-116	9 δ "	114.5

(3). That part of Handke's measures which lies beyond $\lambda=1770$ shows clear evidence of connexion as summation lines with D(1) sets, depending not only on different d_2 sequences (*i. e.* on different multiple Δ origins) but on displaced $d(1)$ sequents and displaced D(∞) limits. This is shown by the large number of separations about 10 to 32 larger than the normal ν and presumably due to the $\nu+\sigma$ separations between \mathbf{D}_{11} and \mathbf{D}_{22} . The corresponding intensities also are in proper order showing a \mathbf{D}_{11} stronger than \mathbf{D}_{22} with in general \mathbf{D}_{12} (the weakest not seen). The following are examples arranged on the supposition that there is no displacement on the limit, *i. e.* $\nu=248\cdot44$. The supposed \mathbf{D}_{12} are in []. It should be remembered that the equally probable errors are about 1.5 for the lines and 3 for the differences.

[56550.4]	(2) 58281.9	}	[59232.9]	[60244.0]	[61909.7]
24.5	64.5		8.7	10.3	9.4
(8) 56525.9	(7) 58217.4	} 249.0	(7) 59224.2	(3) 60233.7	(3) 61900.3
(4) 56798.8	(7) 58530.9		(7) 59481.3	(2) 60492.4	(1) 62158.1

In the last three sets a separation of 10 corresponds to $d\lambda=.3$. The weak line \mathbf{D}_{12} is therefore very close to the \mathbf{D}_{11} and might be overlooked. It should exist in the third set with a strong \mathbf{D}_{22} ; in the others it might really be too weak to be seen. These small σ separations may be regarded as belonging to actually the same value, and if so their mean will be a real approximation to the true value. This is 9.5. It corresponds to a satellite displacement of $24\delta_1$ and is in step with that of $23\delta_1$ for D(2). The second is a strong set, gives the normal ν , and is at least near a $d_2(1)$ depending on a multiple of Δ . It may be well therefore to consider it in a little more detail although no certain conclusions can be drawn on account of the large measure uncertainties. If the ν is normal, the limit is $31523\cdot48$. The \mathbf{D}_{12} gives $d_2(1) = 26758\cdot4 + y$ where $y^2 < \pm 1.7 - 34d\lambda$, and $\mathbf{D}_{12} = 4764\cdot9 - y$. No $d' - d$ combinations are found with these as in the cases discussed above under $d(1)$. The $d_2(1)$ has a denominator $= 2\cdot024528 - 37\delta y$, *i. e.* a mantissa $1024528 - 38y$. Now $140\Delta = 1022992 - 15(x_2 - x_1)$ or 1536 less. The observed may be a sequence displacement on the 140Δ , but as there is no combination found with it the displacement probably takes place in the limit (or on both). If the displacement on $\mathbf{S}_1(\infty)$ is $x\delta$, it decreases the limit by $4\cdot94x$. The $d_2(1)$ sequent as calculated from \mathbf{D}_{12} is increased by the same amount, and its

nantissa consequently decreased. This decrease is found to be $186.9x$. Hence to get the multiple law

$$186.9x = 1536 - 38y + \rho$$

where ρ is an unknown correction due to incorrect value of N and certainly less than 260. Hence

$$x = 8.2 - .20y + 1.37.$$

If there is no N correction $x=8$ or $x=7$ with $y=6$. Hence

$$d_2(1) = 58281.9 + y - 31523.48 + 4.94x = 26758.4 + y + 4.94x,$$

now

$$d_2'(1) = 49061.37, \quad d_1' = 48962.91.$$

Hence

$$d_2' - d_2 = 22302.97 - y - 4.94x = 22262.45$$

$$d_1' - d_1 = 22213.37 - y - 4.94x = 22173.8$$

$$d_1' - d_2 = 22164.1$$

The only lines in this neighbourhood are $(2n) 22252.85$, $(1n) 22188.25$ spark lines by E. V. and $(2n) 22150.21$, $(4) 22168.82$, $(6n) 22178.56$ arc lines. The two last differ by 9.74 , the mean satellite separation as found from the last three sets above. They clearly belong to the $d_1' - d_2$, $d_1' - d_1$ combinations. The spark line 22188.25 is 9.69 ahead of 22178.56 and will correspond to a second satellite displacement of the same amount as the normal. The differences between the calculated and observed will depend on the effect of incorrect N . The further discussion is therefore deferred, but the set provides material for the discussion of the N effect and is of importance for this reason. But the five systems also support the evidence already adduced that several independent D systems exist—at least for $m=1$.

(4). In searching for $F(2)$ lines which should show a separation of about 25 and lie in the region of wave numbers about 16000, whole sets were seen with this separation scattered over a wide area and showing a large number of the p links. These are sure signs of F regions of low order. As material illustrating this the following examples are shown. The wave numbers are in I.A. calculated from wave lengths of Aretz given to $.001\text{A}$. The separation values are therefore very exact and might therefore well repay a more detailed investigation of their relations. Double displacements are clearly present and the 248-separations are links:—

(5n) 15415·61	999·80	(5) 16415·21	(2) 15877·20	249·46	(1) 16126·66 = F_{11}	(2)
	26·11		(2) 15883·75	6·55		
(5n) 15441·72			(2) 15886·62	2·87		
	999·80 = e + .03		(2) 15906·18			
				26·62		
			(2) 15932·80			
(2) 16045·03	248·84	(2) 16293·87				
	25·25					
(2) 16070·28					15877 is δ , $F_{11}(2)(-\delta_1) - .03$	
					15906 is 26·84 ahead of δ , $F_{11}(2)(\delta_1)$	
(2n) 15986·95	248·71	(2) 16235·66		248·68	(1n) 16484·34	
	26·24	(1) 16236·21		·55	(1rv) 16489·67	5·33
		(3n) 16260·46		24·80	(2n) 16490·99	6·55
(4) 16013·19	249·59	(4rv) 16262·78		27·12		25·78
		(3n) 16264·04				(1) 16516·77
	23·97					
(1n) 16037·16	245·73		+	245·73	(1n) 16528·63	
	26·12					
(3n) 16063·28	251·47	(2n) 16314·75		237·51	(2) 16552·26	
	25·52					
(1n) 16088·80	247·77	(4) 16336·57				

s after a line denotes a spark line.

TABLE I.

S.

S.

<i>m.</i>	I.	λ .	<i>n.</i>	Mean.	I.	<i>n.</i>	λ .
2	10	8093·05	12352·89	23·47 ± 2·5	1	50694·0 (50932)	1971·99
	10	7933·50	12601·31	66·7 ± 6·5*			<i>e</i> . 1925
3	8R	4531·04	22063·90	22·96 ± .6	6R	(40982·01)	(-8 δ) 2441·72
	8R	4480·59	22312·36	71·92 ± .5	6	41231·48	2424·62
4 †	2n	3861·88	25886·95	28·35 ± 1·3	10	37169·75	2689·58 <i>s</i>
	1n	3825·13	26135·66	73·26 ± 1·6	2n	37410·87	2672·24
5 §	2n	3598·13	27784·24				
	1n	3566·26	28032·62				
6	1n	3463·6	28863·31				
7	2n	3384·93	29534·28				
8	3?	3335·35	29973·30				

* 6·5 equally probable.
† These are (- δ)S(4), (- δ)S₁(4), and S₂ 4.
§ Also S₁(5) is *u*. 3512·19 and 3688·60. *u* measures *m* = 5-8. Hasbach.

TABLE II.

D.

D.

<i>m.</i>	I.	γ .	<i>n.</i>		I.	<i>n.</i>	γ .
1					1	59916·12 1669·0
2	6	5220·257	19150·81	(23·14±·5)	4	(43895·32)	<i>u.</i> 2242·68
	10 R	5218·376	19157·72	(23·39±·5)	4	(43889·22)	(5½δ) 2276·30
	8 R	5153·422	19399·18	(71·33±·5)	6*	(44143·05)	(5½δ) 2263·20
3	1 <i>n</i>	4063·50	24602·49				
	10 R	4062·94	24605·87	24·17+1	10	38442·47	2600·53 <i>s</i>
	10 R	4022·83	24851·26	70·02±3·5	1	38688·78	2584·0 <i>s</i>
4	2 <i>n</i>	3688·38?	27104·61				
	2 <i>n</i>	3654·6	27355·14	(71·40±·5)	1	(36187·65)	(-3½δ) 2763·80 <i>s</i>
5	6 <i>n</i>	3512·19	28464·24	22·39±·8	2 <i>n</i>	34580·54	2890·97
	4 <i>n</i>	3483·82	28696·05				
6	2 <i>n</i>	3415·89	29266·72	(22·24)	2 <i>n</i>	(33777·76)	<i>e.</i> 2874·60
	1 <i>n</i>	3388·21	29505·84				
7	2 <i>n</i>	3354·57	29801·64				

* Also *u.* 2230·16=44145·49. Mean line : 31772·33±·5.

TABLE III.

P.

$p(1)-p(m)$.

<i>m.</i>	I.	λ .	<i>n.</i>	<i>m.</i>	I.	λ .	<i>n.</i>
1	10 R	3274·06	30534·54	2		18475·93
	10 R	3247·65	30782·77		2 <i>n</i>	5410·97	
2	1	3	2 <i>n</i>	4123·38	24245·24
		2037·28	49069·64			
3	1	1817·3	55026·7	4	2 <i>n</i>	3712·05	26931·74
4	4	1732·4	57723·4§		2 <i>n</i>	3676·99	27188·69
5	*	(1690·87)	(59140·9)	5	2 <i>n</i>	3524·31	28366·38
6	†	(1666·80)	(59995·38)	6	2 <i>n</i>	3422·22	29212·61
					2	3393·09	29463·41

* Two linked lines $u.(8) 1671·6 = 59142·2 - 36 d\lambda$
 (6) 1710·6. $u = 59139·7 - 34 d\lambda$
 mean=40·9.

§ $P_2(4)$.

† From the combination $n = (2n) 29212·61 = p_1(1) - p_1(6)$.

TABLE IV.—A second P series = "Q."
 Q. Q.

<i>m.</i>	I.	λ .	<i>n.</i>	59100+.	I.	<i>n.</i>	λ .
?1	1 <i>n</i>	3656.90	27337.94			far ultra	violet.
	2 <i>n</i>	3624.35	27583.44				
*2	4R	2181.80	45819.64			" "	"
	6R	2178.97	45879.14			" "	"
3		unobserved	region			" "	"
4	3	(-9½ δ) 1834.9	(54619.7)	(74.35±1.7)	1	(627.27'1)	1594.2. <i>e</i>
	8	(10 δ) 1826.1	(54634.3)				
*5	7	1783.7	56063.27	76.50±1.7	1	62289.77	1605.4 *
6	3	†	(56907.24)	(74.36±1.7)	4	61451.48	1627.3 *
	6						
*7	8	1741.0	57438.25	73.50±1.7	9	60908.7	1641.8 *
*8	1	1729.7	57813.49	74.92±1.7	7	60536.3	1651.9 *
*9	8	1721.9	58075.38	(73.16±1.7)		(60270.9)	§

† (7 δ) (3) 1760.0 = 56907.2; (-7 δ) (6) 1754.5 = 56907.2.

§ (-3 δ) (3) 1660.2 = 60271.87; (4 δ) 1657.8 = 60270.03; mean = . . 70.9.

$$q(1) - q(2) \begin{cases} \lambda & n \\ (4n) 5463.55 & 18298.11 \\ (3n) 5408.55 & 18484.20 \end{cases} \quad q(1) - q(4) \begin{cases} \lambda & n \\ (2n) 3695.42 & 27052.98 \\ (1n) 3664.21 & 27283.41 \end{cases}$$

F. TABLE V. F.

<i>m.</i>	I.	λ .	<i>n.</i>		I.	<i>n.</i>	λ .
1		(103627) *	(965)		3	55800.46	1792.1
2	1	6199.195 † I.A.	16126.12	28382.82	1 <i>n</i>	40639.53	2659.4 <i>s</i>
					2 <i>n</i>	40622.16	2460.98
					2 <i>n</i>	40655.36	2458.97
3	2	4649.31 <i>s</i>	21502.65	(12¼ δ) 28386.2	1 <i>n</i>	32739.77	3053.52 §
	2 <i>n</i>	4642.78	21532.88				
4	4 <i>n</i>	4177.87 §	23929.06				
5	1 <i>n</i>	3947.09	25328.06				
6	1 <i>n</i>	2246.43	26163.83				
7	1 <i>n</i>	3748.50 <i>s</i>	26669.94				
	2 <i>n</i>	3745.53	26691.08				
8	2 <i>n</i>	3699.19	27025.42				
	2 <i>n</i>	3695.42	27052.98				
9	1 <i>n</i>	3664.21	27283.41				
10	2 <i>n</i>	3636.01	27494.96				
	2 <i>n</i>	3632.65	27520.39				

* F₁₁ in vacuo, deduced from F₁₁.

† by Aretz.

§ (12¼ δ) F₁₁ and (12¼) F₁₁ (4).

|| Close to S₂ (4). Also a displaced set
nn = 26163.83, 26166.93 *s*, 26188.22
 for F₁₁, F₁₂, F₂₂.

TABLE VI.

$d(2) - f(m)$.

$d(2) + f(m)$.

<i>m.</i>	I.	λ .	<i>n.</i>		I.	<i>n.</i>	λ .
1	2 <i>n</i>	-6621·623 I.A.	-15097·37	12358·15	1	39813·67	2510·95 <i>s</i>
	2 <i>n</i>	-6629·730 „	-15078·90	12385·39	5 <i>n</i>	39849·68	2508·68 <i>s</i>
2		ultra	red.				
3	6	18229·5	5485·61				
	10	18194·6	5496·13				

The $d' - f$ combinations where $d'_1 d'_2$ are the sequents in the inverse set

<i>m.</i>	I.	λ .	<i>n.</i>	
2.	4 <i>n</i>	2724·04	36699·53	5 unobserved region
	4 <i>n</i>	2715·67	36812·61	
3.	6	2369·97	42181·99	6 { 2 (-7 δ_1) 2136·05 (46817·8) 2 (7 δ_1) 2134·51 <i>s</i>
	7	1 (-7 δ_1) 2112·19	48345·5	
4.	2R	2238·52	44658·81	

$d'_2 + f(3)$, $\lambda = (4) 1787·4$ $n = 55947·19 - 31d\lambda$
 gives limit = $49064·6 - 1·5d\lambda \pm 5$.

TABLE VII.

$p(1) - f(m)$.

$p(1) + f(m)$.

<i>m.</i>	I.	λ .	<i>n.</i>	31500+ 31760+			
1			(4078)		1	58969·2	1695·8
2	1	5188·96	19266·38	E.H.			
	2	5120·00 <i>s</i>	19525·91	E.V.			
3	2 <i>v</i>	4056·8	24643·17	71·38	1 <i>n</i>	38648·00	2586·70 <i>s</i>
	1 <i>v</i>	4015·8	24894·76				
4	*	3686·10	27121·48	23·48	2 <i>n</i>	35925·47	2782·73
		3652·3	27372·36	71·98	1	36171·60	2763·60 <i>s</i>
5	6 <i>n</i>	3512·19	28464·24	22·39 ± 8	2 <i>n</i>	34580·54	2890·97
6	2 <i>n</i>	3413·41	29287·98	23·9	6R	33759·83	2961·25
	2 <i>n</i> †	3384·88	29534·86				

* By Stark allowing electric shift.

† This also agrees with $S_1(7)$ and $\epsilon.P_2(1)$.

XLVII. *On the Relation between Illumination and Electrical Conductivity in Selenium.* By A. O. RANKINE, D.Sc., Professor of Physics in the Imperial College of Science and Technology*.

IT appears to have been generally accepted by those who have worked experimentally with selenium that the ultimate increase of conductivity due to illumination is proportional to the square root of the incident light intensity. Fournier d'Albe† quotes the work of Rosse, Adams, Berndt, and Minchin in support of this law, and his own experiments have led him to the same conclusion. The present author, as a result of the experiments about to be described, has found that for several selenium cells made by Fournier d'Albe himself the ultimate increase of conductivity is much more nearly proportional to the *fourth* root of the light intensity. This law has been found to hold over a wide range of intensities, and, without exception, for all the cells tested.

The discrepancy between these results and those by earlier observers may possibly be accounted for by differences in interpretation of what the increased conductivity actually is. Fournier d'Albe, for example, in the paper already alluded to, defines it as being measured by the "recovery" after the cessation of illumination—*i. e.*, the ultimate reduction of current in the selenium cell on constant voltage. But he does not measure this recovery directly, probably because of the long time it requires to become complete. Instead, the procedure is to take early ordinates of the recovery-curve (current-time), and to deduce what the total recovery would be on the assumption that the curve is hyperbolic. No doubt this method results in a saving of time, and for many purposes it may be sufficiently accurate. But it suffers from the defect of being based on an assumption which is by no means exactly true. The recovery-curve is not a true hyperbola, and it is therefore unjustifiable to estimate the true total recovery in the way described. Nor is it necessary, even from the point of view of time-saving. The experiments of the present author indicate that, in spite of the reputation selenium cells commonly have of being subject to unaccountable variations, they are very reliable‡ within certain definite limits, and the

* Communicated by the Author.

† Proc. Roy. Soc. A. vol. lxxxix. p. 75 (1913).

‡ This applies, at any rate, to the particular type of cell used in these experiments.

effect of light on them is quantitatively reproducible again and again. This renders it possible, as will be seen, to measure the ultimate change of conductivity attributable to illumination by the total *increase* of current resulting from the exposure to light. This course seems to be the most rational one, and it has the advantage that it enables observations to be made more quickly than when the recovery is measured. For, as is well known, the maximum conductivity of selenium when exposed to light is attained much more rapidly than is the reduction to minimum conductivity after the light is cut off.

The justification for this method of procedure lies in the fact that, for all the selenium cells examined, the conductivity has been found to be a quite definite function of the intensity of illumination. The cell has a certain conductivity in complete darkness. When it is exposed to light, its conductivity rapidly assumes a higher value, which becomes constant in two or three minutes; and when it is replaced in darkness, although the conductivity decreases much more slowly, the ultimate conductivity is not sensibly different from the original "dark" value. One may therefore take as a measure of the light effect either the increase of conductivity resulting from illumination, or the decrease caused by cutting off the light; and the former alternative is the more convenient in practice because it occupies less time. Care has to be taken, however, to fulfil certain conditions. It has been observed frequently that, in the entire absence of illumination, the current in a selenium cell, to which a constant considerable voltage is applied, increases progressively with time. It is probable that this is mainly due to heating of the selenium by the degeneration of electrical energy in it. Certainly the conductivity increases rapidly with rise of temperature. Whether this be the explanation or not is, for the moment, irrelevant. The experimental fact is that, if the voltage be constantly applied, and the current allowed to flow continually during observations of the effects of illumination, the latter are masked or distorted to some extent by the changes of conductivity attributable directly to the flow of the current. It is possible to eliminate this latter effect practically by permitting the current to flow in the selenium only during the few seconds necessary to make an observation of the conductivity. This is the procedure normally adopted in the experiments here described, and it is in these circumstances that the simple law already mentioned appears to hold with considerable accuracy.

Experimental Arrangement.

The experiments were carried out in a dark room. The selenium cell under test was enclosed in a light-tight box provided with a photographic shutter. It formed part of a circuit consisting of a 4-volt accumulator and a calibrated uni-pivot microammeter of 500 ohms resistance, a key being included in order to complete the circuit at will. In no case did the current exceed 10^{-4} ampere, so that the difference of potential across the selenium did not vary from the e.m.f. of the accumulator by more than $\frac{1}{20}$ volt. The applied voltage was, in fact, constant to within 1 per cent. The source of light used was a metal-filament lamp of 8-candle power running on an 8-volt accumulator. It could be regarded at considerable distances as a point source, since the filament was only 6 mm. long. Changes of the intensity of illumination of the selenium were obtained by placing the lamp at carefully measured different distances from the selenium surface, and the relative intensities were calculated on the basis of the inverse square law. The limits of distance used were 4.5 metres and 0.2 metre, so that the extreme intensities were in the proportion of about 500 to 1. The observations were made in the order of diminishing distance or increasing intensity. First of all, the selenium circuit was made for a few seconds with the selenium in darkness, in order to determine the "dark" current. The shutter was then opened with the source 4.5 metres away, and the current determined at intervals by using the key. When the value had become steady, the distance of the source was diminished and the procedure repeated. It was found that three minutes exposure to each increase of illumination was more than sufficient for the steady state to be attained. About half an hour therefore sufficed to complete the series of eleven observations—a period too short for the temperature of the selenium to change appreciably from chance causes.

In each case the maximum currents thus observed were plotted against the fourth root of the light intensity, or the reciprocal of the square root of the distance between selenium and source. For all the cells examined—four in number,—although they differed considerably in sensitivity to light, the resulting curve was a good straight line. A typical case is shown in fig. 1, on which the dotted curve is also placed to show how much less exact the square-root law is than the fourth-root one. The curve is represented by the equation

$$C - C_0 = kI^{\frac{1}{4}},$$

where C_0 is the "dark" current and C the current corresponding to the intensity of illumination I . The accuracy with

Fig. 1.

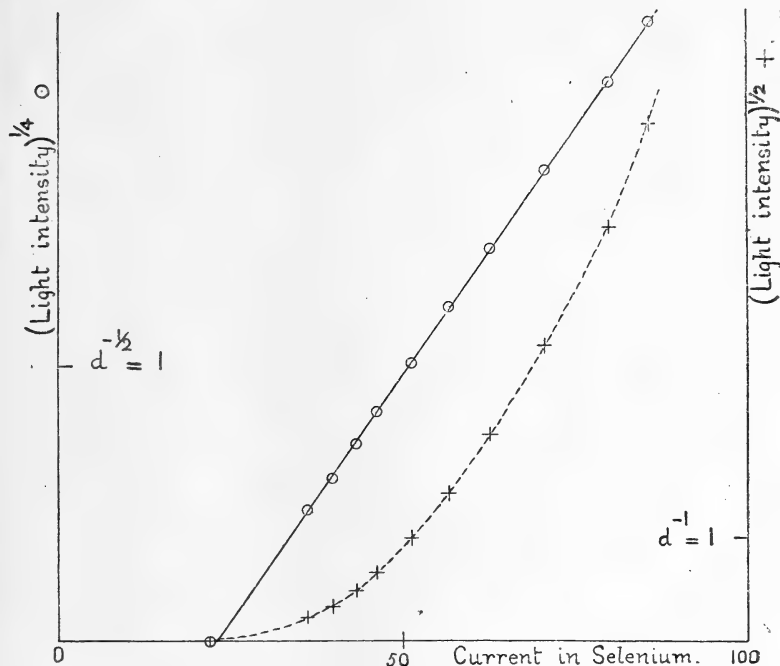

which the law holds may be seen in the following table, where d stands for the distance between the selenium and the source of light. $I^{1/2}$ is proportional to $d^{-1/2}$, so that the constancy of the numbers in the last column is a test of the law. The value of C_0 is 23.1 microamperes, and is deduced by drawing

Distance d (metres).	$d^{-1/2}$.	Current C .	Extra current $C - C_0$.	$d^{1/2}(C - C_0)$.
4.50	0.472	36.2	13.1	27.8
3.00	0.577	39.8	16.7	29.0
2.00	0.707	43.5	20.4	28.9
1.50	0.817	46.3	23.2	28.4
1.00	1.000	51.5	28.4	28.4
0.70	1.195	56.9	33.8	28.3
0.50	1.415	62.9	39.8	28.1
0.35	1.690	70.6	47.5	28.1
0.25	2.000	79.8	56.7	28.4
0.20	2.237	86.0	62.9	28.1

the best straight line through the points. It is nearly equal to 22.0 microamperes, the observed value of the "dark" current.

In the numbers in the last column the greatest variation from the mean is rather more than 2 per cent., and this occurs at low values of C , where an error of observation would be more effective than elsewhere. It has already been mentioned that the observations extend over a range corresponding to a ratio of light intensities of 500 to 1; actually the range is from about $0.4 \frac{\text{candles}}{\text{metre}^2}$ to $200 \frac{\text{candles}}{\text{metre}^2}$. The fourth-root law holds with considerable accuracy throughout.

Fig. 2.

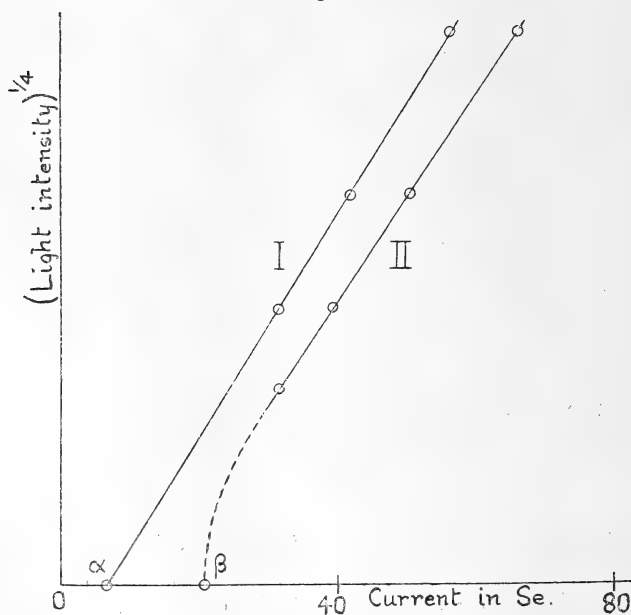

Several series of observations were also taken in which the voltage was applied continuously to the selenium. Before starting any series, however, the current was allowed to flow through the selenium (in darkness) until it had become practically constant—*i. e.*, it was not increasing more rapidly than 0.1 microampere per hour. This state of affairs took several hours to be reached. The procedure was otherwise the same as that already described. Curve II (fig. 2) shows

the kind of the result obtained. The point β represents the "dark" current, and, although the curve is still straight over the range of illuminations used, it does not pass through the point β . This may be contrasted with curve I, which represents the normal case for the same cell—*i. e.*, when the voltage is only applied momentarily to determine the conductivity. Here the straight line does pass through the point α , which represents the observed "dark" current. Curve II indicates that for considerable intensities the "extra" current is still proportional to $I^{\frac{1}{2}}$, if one estimates from a fictitious dark current determined by finding the intercept of the straight part of the curve upon the current-axis. It is clear, however, that the dotted part of the curve requires investigation by means of a more sensitive arrangement than the present one.

Significance of the Results.

The mechanism of the action of light on selenium is not yet known* with certainty. It is probably very complicated, and has to account, for example, for the recent observations by White* that the effect is more marked near the electrodes of the selenium cell than elsewhere. The theory propounded by Fournier d'Albe † that the change of conductivity is due to ionization in the selenium is plausible, and may, indeed, ultimately form the basis of a complete theory. It is worth while to consider in what respects the present results suggest modifications of Fournier d'Albe's assumptions. He assumes that the rate of production of ions is proportional to the incident *flux of energy*—*i. e.* to I ,—and that the rate of recombination is proportional to the square of their number. The steady state is reached when the rates of production and recombination are equal. In this state, therefore,

$$I \propto (C - C_0)^2$$

for the "extra" $C - C_0$ will be proportional to the final number of ions. It is from this proportionality that Fournier d'Albe deduces the theoretical law $C - C_0 \propto I^{\frac{1}{2}}$ mentioned in the beginning of this paper.

From this point of view the significance of the results here recorded would be that $(C - C_0)^2$ is proportional to $I^{\frac{1}{2}}$, and not to I itself. In other words, the rate of production of ions is proportional, not to the incident energy, *but to its square root*. Now, for monochromatic light the square

* Phil. Mag. ser. 6, vol. xxvii. p. 370.

† *Loc. cit.*

root of the energy-flux is proportional to the *amplitude of the electric vector* in the light; and this leads to the view that the rate of ionization is in proportion to the maximum value of the electric force operating on the atoms of selenium. This seems probable enough. Too much stress should not, perhaps, be laid at present on the quantitative aspect of this result. The law $C - C_0 \propto I^{\frac{1}{2}}$ or $(C - C_0)^2 \propto I^{\frac{1}{2}}$ has been found to hold for white light, in which, of course, the amplitude of the electric vector has, at any moment, a variety of values corresponding to the various frequencies; and there is no single value which can be deduced from the total intensity simply by taking the square root. Moreover, it is not just one wave-length which affects selenium; the effect is distributed more or less throughout the spectrum. Further investigation is required in this connexion; and it has already been found that the same law—viz., $C - C_0 \propto I^{\frac{1}{2}}$,—holds when the light red has been rendered more nearly monochromatic by using a filter permitting the passage of 6300 to 7000 A.U. only. Apart from the exact quantitative relation, however, the fact remains that the rate of production of ions is not proportional to the incident flux of energy. And this at least suggests that the effect of light on selenium is in the nature of a “trigger” action rather than the mere transformation of one kind of energy into another.

Imperial College.

Jan. 30, 1920.

XLVIII. *On Gravitation. Theoretical and Experimental Researches.* By Q. MAJORANA, *Professor of Physics in the Polytechnic School of Turin (Italy)*.*

ORIGIN of the *Researches*.—In a preceding paper † on the theory of relativity and on the influence of the movement of the source or of a mirror on the propagation of light, I expressed the doubt whether among other unknown causes that might have some influence on the phenomenon, there might be the gravitational field of the earth. Without pretending to connect now two orders of phenomena so different, I shall give an account in this paper of some recent experiments of mine on gravitation that have their origin in the ones formerly described.

* Communicated by the Author. Translated from the Italian by A. Lion.

† Phil. Mag. xxxv. p. 163 (1918) and xxxvii. p. 145 (1919).

Characters of Newton's Law.—In its simplicity this law seems the most perfect of the physical laws. Up to now no influence of the nature of the medium has been detected in the propagation of the attractive force between two material masses. The researches of Austin and Thwing*, Kleiner†, Laager‡, Cremieu§, Erisman||, and others having in view the discovery of an action of that kind, failed utterly. In consequence of Laager's experiment, in which he studied the weight of a silver ball, covered with a thick coat of lead, it may be thought that the lack of effect has been until now verified up to the approximation of about $5 \cdot 10^{-5}$. The result was obviously a confirmation of the exactitude of Newton's Law.

Doubts on the exactitude of Newton's Law.—It does not seem right to me to deduce from an experiment, like Laager's for instance, that what has been verified in the Laboratory, might repeat itself with the same appearance, even in astronomical cases. Hence it would not be right to deduce therefrom that the mass of the silver ball would appear the same if in the centre of the earth, or in the centre of the sun (333,000 times the mass of the earth).

Let us admit as an hypothesis, that the mass may appear smaller if surrounded by other masses, that is, that there is a diminution of the force of gravitation on account of its propagation across a material medium. This diminution might be owing to a property of the material medium, to be compared with electric or magnetic permeability, or to the progressive absorption of the force. In the first case, if the analogy with the electrical and magnetical phenomena could be proved, small thicknesses of the medium would be sufficient to allow of the verification of the hypothetical permeability of gravitation; this has not been done in the experiments known up to now. In the second case the absorption would occur for very great thicknesses of medium, and therefore escape the researches of the laboratory, and yet manifest itself in the celestial bodies. In consequence, this second hypothesis of absorption seems more probable, and its conception would be more easy, if the force of gravitation could be explained by a kind of energetical flux, continually emanating from ponderable matter. This flux

* Phys. Rev. v. (1897).

† Arch. sc. phys. et nat. xx. p. 420 (1905).

‡ Dissert. Zürich (1904).

§ C. R. cxl. p. 80 (1905); cxli. pp. 653, 713 (1905); cxliii. p. 887 (1906).

|| Vierteljahrschr. liii. p. 157 (1908).

would be gradually absorbed, as in the case of light in its propagation through a not perfectly transparent medium : Newton's Law would only be exact in the first approximation.

Consequences of the Hypothesis of Absorption.—The first consequence would be the knowledge of the *true mass*, and of the *apparent mass*. The true mass would be that property of the mass to which the attractive force is proportional, if it is reduced in very small particles. The apparent mass is, on the other hand, the apparent value that the true mass assumes in consequence of the gradual absorption.

In order to respect the principle of the conservation of energy, it would be required, furthermore, to admit that any kind of matter is gradually transforming itself. This would be analogous, so to speak, to what happens with radium, with the difference that for this substance the transformation lasts some thousands of years, whilst for every one of the other known substances, the transformation would last enormously longer.

Another consequence might be deduced : since the force of gravitation is produced by an energetic flux that has been absorbed, and as the energy cannot be destroyed, it ought to transform itself, into heat, for instance. Therefore matter subjected to gravitation is heated ; this fact would give a new explanation of all the solar heat or of a part of it at least. Furthermore, the hypothesis might be kept in mind when considering the fact, which is nearly certain, that there are no *non-luminous* stars of great dimensions in the sky ; ponderable matter ought to heat itself if condensed into little space.

It is, however, with the utmost reserve that I state the hypothesis of the energetic character of the force of gravitation ; and if considerations that I do not detect at present should arise in the future and make me judge it erroneous, I should withdraw it.

I rather consider as probable, and in fact, after some experiments that I shall describe as certain, the hypothesis of gravitational absorption.

Analytical Researches.—In order to be able to establish a plan of experiments with the purpose of verifying the hypothesis of absorption, it is necessary to consider this hypothesis analytically. A physical quantity, *sui generis*, can now be defined and called *flux of gravitational action* ; it is not yet necessary to connect the notion of this quantity with the notion of energy. Let us suppose a material particle dm so small that its inner gravitational absorption might be

valued as null. We can suppose, in consequence of the above stated hypothesis, that it would continually put forth a certain flux, proportional to dm , that is to say, kdm , uniformly irradiated in all directions. Let us suppose the particle to be in a vacuum ; across a solid angle subtending the surface $d\omega$ at the distance of 1, the flux would only be

$$\phi = k \frac{dm d\omega}{4\pi}.$$

If the particle instead of being in a vacuum is in a medium of true density δ_v , the flux that will have arrived at the distance x from the particle, will be expressed by

$$\phi = k \frac{dm d\omega}{4\pi} e^{-Hx}. \quad \dots \dots (1)$$

This is equivalent to admitting a gradual absorption of the flux, proportional to its value at every point, to the thickness of the medium that has been crossed, and to the medium's density. It is supposed, in fact, that

$$H = h\delta_v, \quad \dots \dots (2)$$

H being the *quenching factor* for the density δ_v , and h the quenching factor for density 1.

We will now consider a massive sphere, with the uniform density δ_v ; and determine the flux that emerges from it. Let us call R its radius, O its centre (fig. 1). I consider an

Fig. 1.

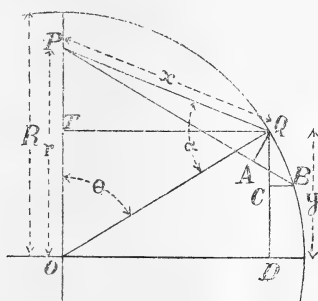

inner point P of it, in which the mass dm would be concentrated. I trace the PO radius of the sphere passing through P ; and I trace QPB , an infinitesimal angle, with the vertex at P ; I trace QA perpendicular to PQ . I say : $OP = r$; $PQ = x$; $QD = y$. I make the triangle QPA turn around

the PO axis; the AQ segment will trace the $2\pi \cdot \text{TQ} \cdot \text{QA}$ surface. It is possible in equation (1) to substitute for $d\omega$ this surface, reduced to unit distance from P, that is to say, dividing it by x^2 . We have

$$\phi = k \frac{dm \text{TQ} \cdot \text{QA}}{2x^2} e^{-Hx}.$$

QD is to be traced parallel to OP; B projected normally to QD on c ; we have $Qc = dy$. I call $\hat{P}\hat{Q}O = \alpha$; $\hat{P}O\hat{Q} = \theta$; it appears from the figure that

$$dy = \text{QB} \sin \theta; \quad \text{QA} = \text{QB} \cos \alpha;$$

therefore $\text{QA} = \frac{dy}{\sin \theta} \cos \alpha.$

Moreover,

$$\text{TQ} = \text{R} \sin \theta; \quad x = \sqrt{\text{R}^2 + r^2 - 2ry}.$$

Differentiating

$$dy = -\frac{x dx}{r}.$$

From the triangle OPQ we have

$$r^2 = x^2 + \text{R}^2 - 2x\text{R} \cos \alpha,$$

therefore $\cos \alpha = \frac{x^2 + \text{R}^2 - r^2}{2x\text{R}}.$

Hence we have

$$\phi = -k \frac{dm}{4r} \left(1 + \frac{\text{R}^2 - r^2}{x^2} \right) e^{-Hx} dx.$$

Let us call dF the total flux of action that is put forth by the dm particle, and that succeeds in emanating itself from the sphere; this flux will be given by the integral of ϕ , taken between $\text{R} + r$ and $\text{R} - r$ limits,

$$dF = -k \frac{dm}{4r} \int_{\text{R}+r}^{\text{R}-r} \left(1 + \frac{\text{R}^2 - r^2}{x^2} \right) e^{-Hx} dx;$$

and carrying out the integration

$$dF = k \frac{dm}{4r} \left[\frac{e^{-Hx}}{H} + \frac{(\text{R}^2 - r^2)}{x} e^{-Hx} + H(\text{R}^2 - r^2) \int \frac{e^{-Hx}}{x} dx \right]_{\text{R}+r}^{\text{R}-r}.$$

Extending up to the limits, where it is possible,

$$dF = k \frac{dm}{4r} \left[e^{-H(R-r)} \left(\frac{1}{H} + R + r \right) - e^{-H(R+r)} \left(\frac{1}{H} + R - r \right) - H(R^2 - r^2) \int_{R-r}^{R+r} \frac{e^{-Hx}}{x} dx \right].$$

The integral remaining in this expression is transcendent, and one can only obtain its value by developing this expression in series; but this can be avoided by an opportune artifice. Let us call dm not only the mass that is contained in the point P, but all the mass of a spherical layer whose radius is r and thickness dr ,

$$dm = 4\pi r^2 \delta_v dr,$$

therefore

$$dF = k\pi \delta_v r dr \left[e^{-H(R-r)} \left(\frac{1}{H} + R + r \right) - e^{-H(R+r)} \left(\frac{1}{H} + R - r \right) - H(R^2 - r^2) \int_{R-r}^{R+r} \frac{e^{-Hx}}{x} dx \right].$$

To obtain the value of the total flux that emerges from all the points of the sphere, it is necessary to integrate this expression from 0 to R, and we have

$$\begin{aligned} F &= k\pi \delta_v \int_0^R r dr \left[e^{-H(R-r)} \left(\frac{1}{H} + R + r \right) - e^{-H(R+r)} \left(\frac{1}{H} + R - r \right) - H(R^2 - r^2) \int_{R-r}^{R+r} \frac{e^{-Hx}}{x} dx \right] \\ &= k\pi \delta_v \left[\frac{2R^2}{H} - \frac{2R}{H} + \frac{1}{H^3} - \frac{1}{H^3 e^{2HR}} - H \int_0^R r(R^2 - r^2) dr \int_{R-r}^{R+r} \frac{e^{-Hx}}{x} dx \right]. \end{aligned}$$

We can carry out the double integration of the last term, changing the order of integration; but it is necessary to change also suitably the limits of integration. Proceeding in this way, and making $p = RH$, we have finally

$$F = k\pi \delta_v R^3 \left[\frac{1}{p} - \frac{1}{2p^3} + e^{-2p} \left(\frac{1}{p^2} + \frac{1}{2p^3} \right) \right]. \quad (3)$$

The external action of gravitation can therefore be considered as the effect of this flux. Inasmuch as k is the coefficient

of proportionality that gives the Newtonian force as a function of the apparent mass, calling this mass M_a , we have

$$F = kM_a; M_a = \pi\delta_v R^3 \left[\frac{1}{p} - \frac{1}{2p^3} + e^{-2p} \left(\frac{1}{p^2} + \frac{1}{2p^3} \right) \right]. \quad (4)$$

If we put

$$\psi = \frac{3}{4} \left[\frac{1}{p} - \frac{1}{2p^3} + e^{-2p} \left(\frac{1}{p^2} + \frac{1}{2p^3} \right) \right], \quad \dots \quad (5)$$

we have

$$M_a = \frac{4}{3} \pi \delta_v R^3 \psi = M_v \psi, \quad \dots \quad (6)$$

in which M_v represents the true mass of the sphere. Moreover we have

$$M_a = \frac{4}{3} \pi \delta_a R^3; \delta_v = \frac{\delta_a}{\psi}; \delta_a = \delta_v \psi; \psi = \frac{\delta_a}{\delta_v}. \quad (7)$$

It is easy to see that

$$\lim_{p=0} \psi = 1, \quad \dots \quad (8)$$

and hence

$$\lim_{p=0} M_a = M_v.$$

Fig. 2.

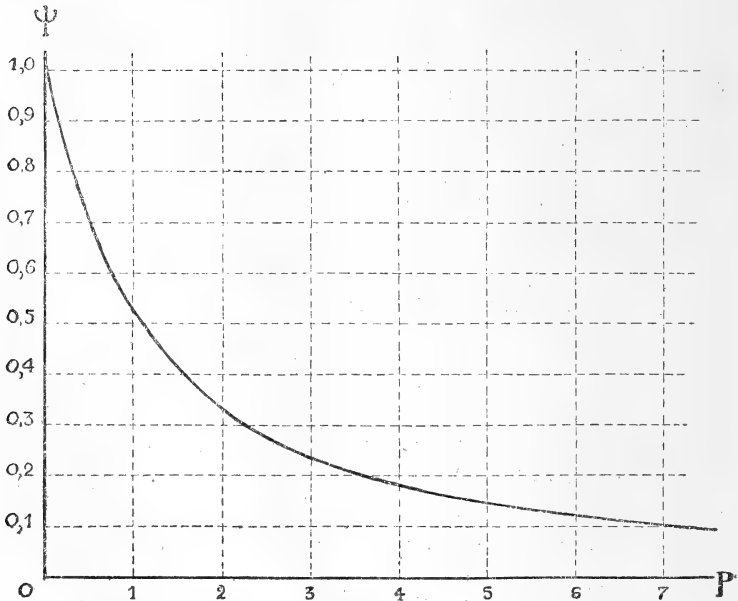

That is to say, that the apparent and true mass coincide if $p=0$, that is to say, if it is a question of a sphere with a very small radius, or if $H=0$. In fig. 2 the values of p are set

down on the abscissa, and the ψ values on the ordinates; in this way the curve corresponding to equation (15) is obtained. It touches the axis of the ordinates with a value 1 (see (8)); and it is asymptotic to the axis of the p 's.

Application of the ψ function to the Sun.—The sun's density is assuredly not uniform; but for a roughly approximate research I shall suppose this density to be constant, and equal to δ_o . Its apparent density is the astronomical one, and we have $\delta_a=1.41$. Several hypotheses can be made as to the real value of δ_o for the sun; for each of them one can calculate the value of ψ by means of (7); then, from the curve of fig. 2, the corresponding value of p can be deduced; and finally, since $p=R\dot{H}=R_s\delta_o h$, we can deduce the value of h , seeing that the sun's radius is $R_s=6.95 \cdot 10^{10}$ cm. We can construct the following table:—

	$\delta_o=1.41$	2	5	10	15	20
$\psi=\delta_o/\delta_v=1$	0.705	0.281	0.141	0.094	0.070	
$p=0$	0.53	2.46	5.20	7.95	10.40	
$p/R_s\delta_o=0$	$3.81 \cdot 10^{-12}$	$7.08 \cdot 10^{-12}$	$7.49 \cdot 10^{-12}$	$7.63 \cdot 10^{-12}$	$7.64 \cdot 10^{-12}$	

Hence we see that if the true density is increasing, the h value increases rapidly, up to a density of about 2; and then more slowly, with a tendency towards a limit-value that we can see remains fixed at $7.65 \cdot 10^{-12}$.

Furthermore, we can see that, even admitting only a true density of the sun slightly greater than the apparent (*i. e.* 2), the order of magnitude for the h quenching factor remains fixed between 10^{-12} and 10^{-11} .

The h factor.—According to the already made hypothesis, the h factor represents a *universal constant*, upon which the measure of the gravitational absorption depends; and its probable value would be, as aforesaid, fixed between 10^{-12} and 10^{-11} ; but its exact determination cannot be arrived at by considering the solar phenomenon. In fact, we lack the necessary elements to enable us to state the true density of the sun; perhaps we can believe it to be certainly greater than 1.41 (apparent or astronomical density), when we consider the great density of some heavier bodies. The sun's very high temperature, that would have the effect of dilating to an enormous extent such bodies, might be compensated by the enormous pressure in the solar mass interior. Anyway the value of the aforesaid true density of the sun cannot be established *a priori* with sufficient exactitude.

We can then imagine an experimental method for the investigation of the h constant. It would consist in finding

Fig. 3.

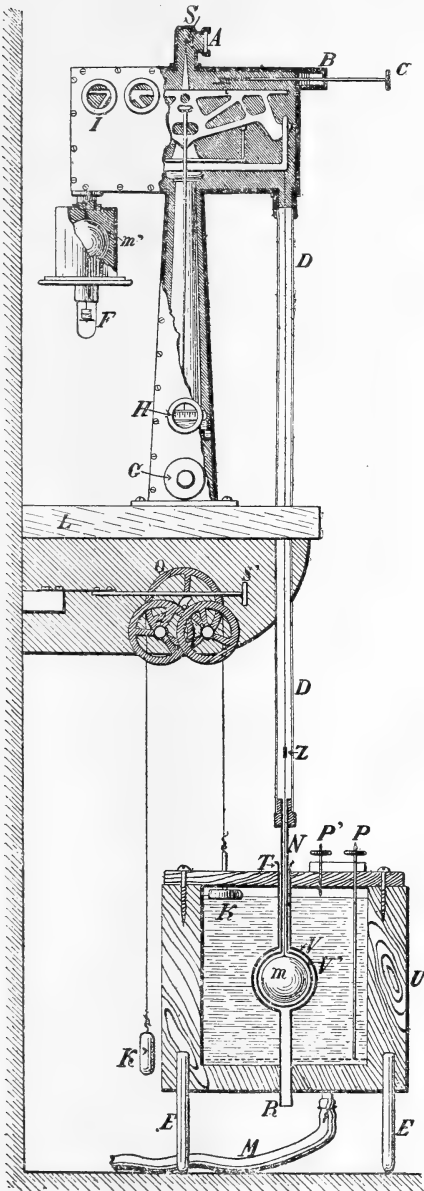

pressure when the vacuum was established in it. Special artifices have been devised in order to command from outside the beam and the little rider of a centigram upon it. The scales' original plates also have been taken off. Under the right arm of the balance a glass tube D has been fixed to the protecting box; this tube connects the box itself with the ambient in which is the mass m , as will be described further on. Under the left arm is a metallic protection that contains a leaden ball m' , which acts as tare of the mass m : this is also a leaden ball. On the beam at its middle point is a concave mirror S for the observation of the oscillations with a beam of light and vertical scale. The balance and the box are on the bracket table L fixed to the wall.

Under L and on the floor of the room is the recipient U, destined to receive the mercury that will surround the mass m . It is made out of very strong pieces of wood joined together; it is a cylinder whose diameter and inner height are about 22 cm. In the axis of the cylinder U are fixed two brass tubes R, T, of which one is the prolongation of the other, and these are joined by means of a hollow brass sphere V, whose diameter is 79 mm. This sphere can be separated in two pieces by means of a joint with screws in its diametral horizontal plane. In the interior of V and concentric with it there is a second hollow brass sphere V', whose diameter is 70 mm. It is connected by means of a brass tube N to the glass tube D, that comes down from the balance. The sphere V' and the tube N do not come in contact with any point of the sphere V and tube T. The sphere V' can be separated, like V, into two hemispheres; so that it can contain the leaden ball m . This is suspended, by means of a brass wire, to the right arm of the balance, through the tubes D and N. The enlargement Z of this wire allows us to control with the cathetometer the position of the m ball, relatively to the recipient U. In this the mercury can flow upwards; this liquid can be removed at will by aspiration. The levels that the mercury reaches when U has been filled or emptied nearly completely are controlled rigorously by electric contacts P, P', that can be easily regulated. Moreover, a delicate system consisting of a float K and its counterpoise K' shows, by means of a mirror S', the position that the mercury takes every moment in the recipient U. All the fittings are made with a precision superior to 2/10 of a millimetre; within this limit it can be reckoned that the mercury has its centre of gravity coincident with the centre of gravity of m , the leaden ball. This has a mass of 1274 gr.; the mercury of 104 kg.

The balance with its accessories maintains the vacuum in

a way practically perfect. Even after twenty-four hours the inner pressure does not rise above 7/10 mm. of mercury, which represents the vapour tension of the mastics used to seal the balance. While the tests are going on, the mercury's rotatory pump must be kept going to reduce the pressure to less than 1/10 mm. of mercury. Under such conditions the perturbations of temperature that result from the mercury surrounding the V' and V capsules are completely avoided.

The observations are made with a beam of light reflected by S on a scale at the distance of 12 m.; it is possible to detect 1/10 mm. on this scale. The sensibility of the balance can be brought in this way to a deviation of 170 mm. for the beam of light *per mg.* Hence it becomes possible to estimate about 1/1700 mg. in a direct reading, and reach a superior preciseness with many observations.

However, a doubt arises, is not such a preciseness illusive, and will not the slightest causes of perturbation hide completely a deviation of a few millimetres? I have nevertheless been able to remove all the more considerable causes of error. The most important of these consisted of the external mechanical shakes produced by the life of the town. I avoided them either by making my observations in the night or by availing myself of the days of the general strike, in this respect very useful.

Observation on the variation of weight.—The effect of the presence of mercury around the ball *m* was ascertained in the following way. In the recipient U determinations of

Fig. 4.

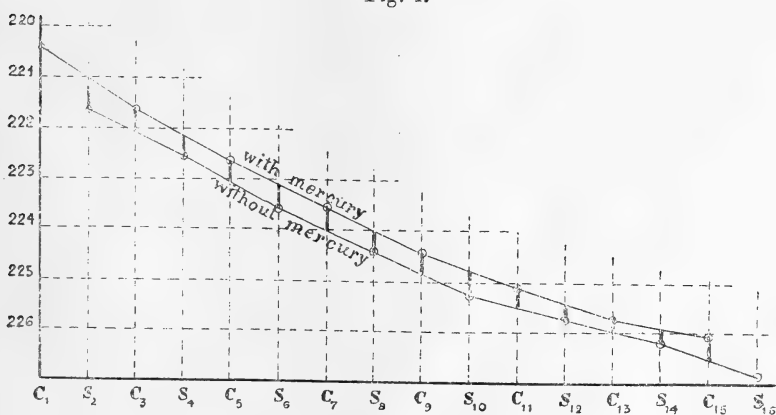

the balance position of rest were made rapidly and alternately with and without mercury. Fig. 4 shows the diagram of one of this series of observations, carried out on July 20-21, 1919.

As abscissæ I take the successive intervals of time $C_1 S_2$, $S_2 C_3$, $C_3 S_4$, $S_4 C_5$,, all equal, elapsing between the single observations *with mercury* and *without mercury* alternately. As ordinates I take the scale's positions of rest, determined each of them with three readings of oscillations. I join the points obtained in this way with two lines. These have a descending direction caused by the gradual displacement of the rest position of the balance, which displacement is a consequence of slight variations in the temperature. But the *with-mercury line* is always, with its points, above the *without-mercury one*. This means that the presence of the mercury *always* makes the leaden ball *m seem lighter*. In the same fig. 4 the 14 vertical segments represent the various successive means obtained from the represented series of observations. For briefness sake I shall not report all the other diagrams corresponding to five other series of observations that were made, together with the one described in fig. 4, on July 20 and 21. I shall say only that, taking the general mean of 57 partial means, I find as the value of the displacement of the balance position of rest, due to the presence of the mercury,

$$\text{mm. } 0.358 \pm 0.012 ;$$

the probable error 0.012 has been calculated by the method of least squares. The direction of the displacement indicates a diminution of weight, that is to say, *absorption of the terrestrial force of gravitation* on the leaden ball through the mercury.

The balance sensibility in the course of the aforesaid experiments was constantly equal to 171 mm. per mg. Therefore that displacement corresponds to a variation of

$$\text{mg. } \frac{0.358 \pm 0.012}{171} = \text{mg. } 0.00209 \pm 0.00007.$$

Correction of the observed effect.—However, it must be stated that in the experiment carried out in this way, several causes intervene, and superposing themselves with their own effects upon the phenomenon sought, modify the result notably. I cannot in this brief exposition discuss such causes in detail ; but among them I select those which have sensible effect, and I construct with them the following table (each bears its own sign) :—

Observed effect	+mg. 0.00209	± 0.00007
Newtonian effect of the Hg on the tare	-mg. 0.00085	
" " " receptacle of Hg	+mg. 0.00007	
" " " floats K and K'	-mg. 0.00034	
" " " Hg on the beam	mg. 0.00000	
Correction for the displacement of the zero...	+mg. 0.00001	
Greatest error admissible for asymmetry	mg.	± 0.00009
Net effect	$\epsilon = +\text{mg. } 0.00098$	± 0.00016

The four corrections given here for the Newtonian effects of the mercury and float K with the K' counterpoise have been rigorously calculated. Their probable error is very much inferior to the probable error of my observations. The greatest error admissible for asymmetry in the mercury's position relatively to the leaden ball, estimated at ± 0.00009 mg., is certainly superior to the true one: it has been my purpose to exaggerate in its admission, to show that it cannot cover the phenomenon that has been discovered.

Hence we have a net diminution of weight undergone by the leaden ball weighing 1274 gr., and this diminution is equal to 0.00098 mg. (that is to say, $7.7 \cdot 10^{-10}$ of its value) due to the fact of the ball being surrounded by the mercury.

Possibility of other causes of error.—In the detailed relation of these experiments that will be published by the *Accademia dei Lincei* in Rome, I discuss minutely the possibility of other causes of error. Here I shall simply enumerate them:—

- I. Perturbations of a mechanical character, such as the effects of the weight of the mercury on the balance of the projection lamp, the position of the scale, or the deformation of the recipient U, augmentation by compression of the density of the mercury, &c. ;
- II. Perturbations of a calorific character ;
- III. Radiometric actions ;
- IV. Electrostatic actions ;
- V. Magnetic actions ;
- VI. Electromagnetic actions.

I shall add only that such causes of error, if intervening, cannot modify sensibly the result that has been obtained.

Determination of the h constant.—The already verified variation of weight allows the valuation of the universal quenching constant *h* at least between certain limits of approximation. I make use of the relations (9) and (10). I must, however, introduce an hypothetical simplification in the experiment as performed if I want to avoid a very great

difficulty of calculation ; moreover, for a first research of the kind, it may be permitted. I shall suppose the leaden mass m , weighing 1274 gr. concentrated in one point ; I shall suppose, moreover, the mass of mercury, weighing 104 kg. transformed from cylindrical to spherical shape, though containing still concentrically the V sphere (fig. 3). The radius of the mercury sphere so resulting will be equal to 12.35 cm. Finally, the thickness of mercury crossed by the single gravitational actions that the lead puts forth (or receives) can be rated, always in rough approximation, as equal to the difference between the radius of the mercury sphere and the sphere V. This corresponds to $12.35 - 3.95 = 8.40$ cm. Consequently we have in the formula (10) :

$$\epsilon = 9.8 \cdot 10^{-7} \text{ gr.} ; m_v = 1274 \text{ gr.} ; \delta = 13.60 ; r = 8.40 ;$$

and hence

$$h = \frac{9 \cdot 10^{-7}}{1274 \cdot 13.60 \cdot 8.4} = 6.73 \cdot 10^{-12}.$$

The order of magnitude in this determination coincides with the one predicted.

Application of the experimental result to the Sun's case.—The results already obtained are based chiefly upon the hypothesis that the sun's astronomical density, called here *apparent*, may be inferior to another density: the true density. Making always the simplification, deriving from the hypothesis of the constancy of the sun's true density, it can be considered as determined by the experiment described above. Let us call R_s the sun's radius, δ_{rs} , δ_{as} , its densities (apparent and true). Putting $p = RH = R\hbar\delta$, we have for the sun

$$p_s = \hbar\delta_{vs}R_s.$$

To p_s 's value corresponds a determinate value ψ_s of the ψ function, which might be deduced from fig. 2, if δ_{vs} were known to us. Now, from (7), we have

$$\delta_{vs} = \frac{\delta_{as}}{\psi_s} ;$$

therefore

$$p_s\psi_s = \hbar R_s\delta_{as}.$$

Since $R_s = 6.95 \cdot 10^{10}$ cm. $\delta_{as} = 1.41$; $\hbar = 6.73 \cdot 10^{-12}$; we have further

$$p_s\psi_s = 6.18 \cdot 10^{-12} \cdot 6.95 \cdot 10^{10} \cdot 1.41 = 0.660.$$

This condition must be satisfied. Considering the curve in fig. 2 we note that for the point $p = 2.0$, $\psi = 0.433$, and

this really does happen. Hence I will put $p_s = 2.0$, $\psi_s = 0.433$, and from this we can deduce

$$\delta_{vs} = \frac{\delta_{as}}{\psi_s} = \frac{1.41}{0.433} = 4.27.$$

That is to say, *it ensues that the sun's true density is the triple of what it is believed to be by the astronomers (1.41).*

But, although considering it possible to take as true the general result about a true density greater than the apparent, I do not attach exceeding importance to the determination I have been working out. The problem on the research of the true density so laid down, shows itself to be rather uncertain. In fact, it is sufficient to admit even a relatively slight error in the determination of ϵ , to have the value of δ_{vs} notably altered. That can be deduced from the following table:—

ϵ .	h .	δ_v .
0.0007	$4.80 \cdot 10^{-12}$	2.42
0.0009	$6.18 \cdot 10^{-12}$	3.27
0.00098	$6.73 \cdot 10^{-12}$	6.73 (experimental determination).
0.0011	$7.55 \cdot 10^{-12}$	10.04
0.0012	$8.23 \cdot 10^{-12}$	—

i. e., it is enough to admit $\epsilon = 0.0011$, to have the true density rise to 10.04.

But, considering the ψ function, we come to note an interesting consequence: the h constant cannot be greater than $7.55 \cdot 10^{-12}$; because if it were, in the sun's case the following expression ought to be exact:

$$\frac{p_s \psi_s}{R_s \delta_{as}} > 7.65 \cdot 10^{-12}, \text{ or } p_s \psi_s > 0.75,$$

and such a condition never can be verified from (5), which for great values of p , gives at most $p\psi = \frac{3}{4}$.

In other words we can also say *inasmuch as the sun has an apparent density equal to 1.41, the coefficient of absorption h cannot be greater than $7.65 \cdot 10^{-12}$.* The experiment gives $6.73 \cdot 10^{-12}$; therefore the facts agree up to now with the proposed theory.

I bring these considerations to a close, calling attention to the fact that if we admit the hypothesis of gravitational absorption, the calculation worked out for the sun with the simplification of constant density cannot lead us to very erroneous results. In fact, if we substitute for this hypothesis of constant density, another law of variable density, this will be, as a matter of course, greater at the centre than at

the surface. Therefore, on the one hand, the fact that the matter would accumulate itself towards the centre would have for consequence that the absorption of the gravitational force of the greatest part of the matter would be accomplished across greater thickness, as the gravitational action would have to pass first chiefly from the deeper layers to the surface, then to the exterior; but, on the other hand, the exterior mass has a reduced density, hence the absorption itself is diminishing. Therefore these are two contrary causes that in general will not balance each other, but the effect of one is subtracted from the effect of the other, leaving the mean true density not very different from the one established by my experiment and calculation.

Summary and Conclusion.—Examining Newton's Law, I have come to think that the force of gravitation can weaken itself by absorption due to ponderable matter. Following other arguments, I have come to suspect that the matter which shows the force of gravitation might heat itself. Although such conception might resolve in a new way the old controversy on the origin of the sun's heat, I state it with all reserve.

I have undertaken afterwards to treat theoretically the case of a spherical mass with constant density, subject to the absorption of its own force of gravitation, and from this work I have deduced the elements necessary to carry out an experimental control of my hypothesis. I have carried out this experiment by weighing *in vacuo* a leaden ball whose weight was 1274 gr. symmetrically surrounded by 104 kg. of mercury. Having previously avoided all the possible causes of error, I have been able to conclude that *the leaden ball loses $7.7 \cdot 10^{-10}$ of its weight by the presence of the mercury.* Such result causes the determination of the *quencling constant* (factor of absorption) per unit of density and length, as $6.73 \cdot 10^{-12}$.

Applying finally this result to the sun's case, I calculate its true density as 4.27.

The importance of this research is obvious, and I do not think that reasons for criticism can easily be found. Anyway, as I am the first to wish to test in all possible ways the results I am publishing, I may mention that it is my intention to repeat my experiments with far bigger apparatus. For the purpose, in the Laboratorio di Fisica del Politecnico di Torino (Italy), an apparatus is being built in such proportions as will render possible an experiment with 10,000 kg. of lead. On the results that I shall obtain with it I shall report in due time.

XLIX. *The Hot-wire Anemometer: its Application to the Investigation of the Velocity of Gases in Pipes.* By J. S. G. THOMAS, M.Sc.(Lond.), B.Sc.(Wales), A.R.C.S., A.I.C.*

[Plates X.-XIII.]

THE possibility of utilizing the cooling effect experienced by a fine heated platinum wire, when immersed in a stream of fluid, as a method of practical anemometry has been placed on a sound theoretical basis by King †. Morris ‡ has examined the characteristics of wires of various kinds for use in this connexion, and has described a number of methods of employing the hot wire for the same purpose. Both these investigators § and others || are responsible for types of so-called hot-wire anemometers to be employed for the measurement of the velocity of air-currents. The author has recently had occasion to examine the possibility of the use of such instruments in an investigation connected with the flow of gases through pipes and orifices, upon which he is at present engaged, and the present paper contains an account of certain interesting results obtained as the result of such examination. Of the various types of hot-wire anemometers available, the type due to Morris and described by him in Eng. Pat. 25,923/1913, was found on examination to be the most suitable for the purpose of the investigation. This type of anemometer is constituted of four equal wires of the same material—platinum by choice—composing the four separate arms of a Wheatstone bridge. One pair of alternate arms of the bridge is shielded by means of surrounding tubes; the resistances being all adjusted to equality initially at any temperature, the bridge remains balanced at any other temperature. The bridge-wires being inserted into a stream of fluid, the balance of the bridge is upset, the unshielded arms alone being subjected to the cooling effect of the fluid current, and the galvanometer deflexion serves, after calibration of the instrument, to measure the velocity of the stream. Morris, in the calibration of his instruments, employed air-currents produced in a vertical wind channel, the stream of air passing vertically downwards therein, at

* Communicated by the Author.

† Phil. Trans. Roy. Soc., A. 520, 214, pp. 373-432 (1914). Phil. Mag., 1915, p. 570.

‡ British Association, Dundee, 1912; Electrician, Oct. 4, 1912, p. 1056; Engineering, Dec. 27, 1912.

§ King, Eng. Pat. 18,563/1914; Morris, Eng. Pat. 25,923/1913.

|| See e. g. King, Phil. Trans., *loc. cit.* p. 404.

right angles to the anemometer bridge-wires. The heated wire in King's calibrations was attached to a radial arm which was capable of being rotated in a horizontal circle. The wire in these latter experiments was used horizontally, vertically, and inclined at 45° to the vertical, respectively. The conditions of calibration in the experiments both of King and of Morris differ essentially from the conditions ruling in the case of the flow of gas in a tube or pipe. The anemometer employed in the present experiments is shown diagrammatically in fig. 1, and a transverse section across the

Fig. 1.

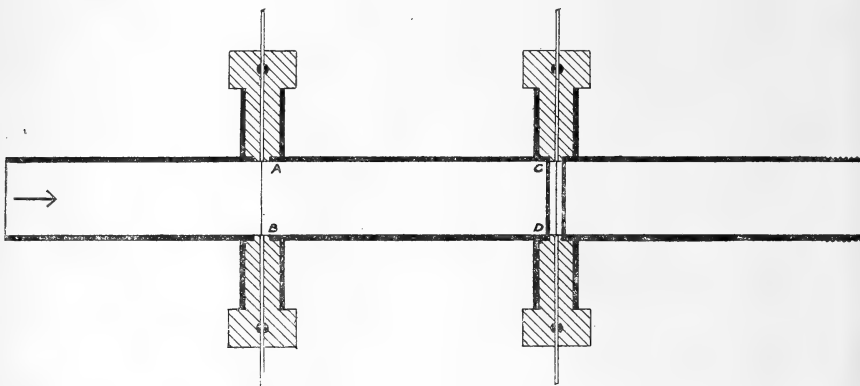

tube at the exposed platinum wire is shown in fig. 2. Two fine platinum wires (the one AB exposed, the other CD shielded within a surrounding copper tube) were inserted, as shown, in the tube, through which a current of air or other

Fig. 2.

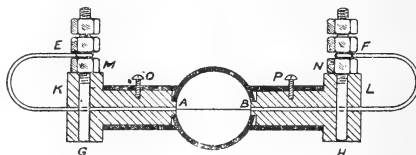

gas flows. The manner of inserting the wires is best seen in fig. 2. The ends A and B of the fine platinum wire are affixed, by means of the smallest amount of silver solder affording a secure junction, to portions of considerably thicker copper wire AE and BF as shown. These copper wires pass tightly through holes bored through plugs of ebonite K and L inserted into brass tubes joined to the main tube at right angles as shown in figs. 1 and 2. Precautions

were taken that the ends of these plugs were diametrically placed with respect to the section of the flow-tube, and that the continuity of the transverse section of the latter was not disturbed by the insertion of the ebonite plugs. The position of these plugs was secured by means of screws O and P. The copper wires AE and BF passed through fine holes in the rods G and H, and by tightening up the nuts M and N the positions of the copper wires were secured. The ends of the copper wires were secured as shown between nuts on the rods, which also conveniently served as terminals for inserting the fine platinum wire in any desired circuit. The protected wire CD was inserted and secured in like manner. The wires AB and CD were cut from the same sample of platinum wire secured from Messrs. Johnson and Matthey. The sample was aged by the passage of a current of 1.8 amp. for 2 hours or so. Their respective diameters were measured by means of a high-power microscope carried on an accurate micrometer-screw measuring to 0.01 mm. and by estimation to 0.001 mm. Portions were chosen of as nearly as possible the same radius, and whose surfaces were pitted as little as possible. The lengths of the wires employed were, as nearly as possible, equal to the diameter of the flow-tube in which they were inserted. The wires were located in the flow-tube at such a distance apart that disturbances of the flow set up by the presence of CD produced no effect at AB*. The two wires constituted two arms of a Wheatstone bridge, the remaining arms of which were formed of resistances unplugged from a resistance-box. The individual resistances of the box were composed of manganin of negligible temperature coefficient, and the individual resistances were found to be correct to 1 part in 5000. The battery and galvanometer were connected to the bridge in the manner indicated in fig. 3. AB represents the protected wire and BC the uncovered wire. AD and DC represent resistances unplugged from the resistance-box. In general, AD was adjusted to either 1000 ohms or 2000 ohms. The battery is shown at E. By means of the rheostat R the total current in the bridge, as indicated by the ammeter M, could be adjusted to any desired value and maintained constant. The ammeter was a direct-reading Siemens and Halske millivoltmeter provided with shunts. Readings could be made to 0.002 amp. by estimation in the region of 1 amp. Calibration of the instrument against a standard Weston instrument indicated that its readings were correct

* It can be shown, see *e. g.* King, Phil. Trans. A. 520, p. 405 (1914), that the disturbance at a point distant from the inserted tube equal to 10 times its radius amounts to only 1 per cent. of the velocity thereat.

to within 0.2 per cent. The drop of potential along AB could be measured by means of the Weston voltmeter for resistance about 1000 ohms, which could be inserted for the purpose by means of the key K. The resistances of the wires

Fig. 3.

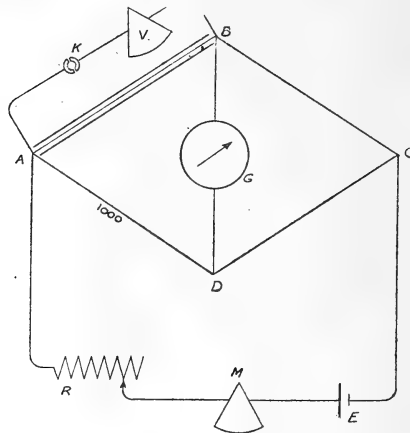

AB and BC when heated by the currents employed were of the order 0.5 ohm. It is evident that to 1 part in 2000, the whole of the current in the bridge when balanced, passes through the arms AB and BC. A bridge connected and employed in this manner may be described as a constant-current bridge, possessing maximum sensitiveness in accordance with Maxwell's rule, and with the maximum generation of heat in the sensitive branch. The bridge employed in King's experiments was of the constant-temperature type, the balance of the bridge after disturbance due to the cooling effect of the current of fluid being restored by the passage of additional current through the wire.

Fig. 4.

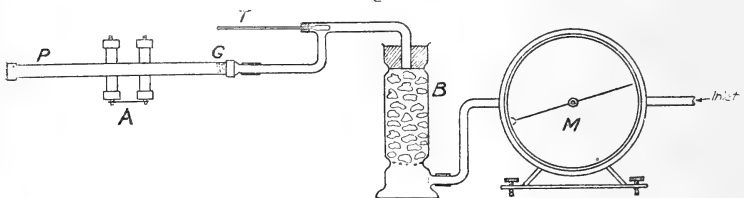

The general mode of employing the anemometer in the present series of experiments is shown in fig. 4. The air or

other gas is passed through the gas-meter M, and thence to a wide tower loosely packed with lumps of calcium chloride. A thermometer T is placed in the stream at a point just prior to the gas entering the brass pipe P in which the anemometer A is inserted, a gas-tight junction between the ends of the anemometer tube and the remainder being effected by means of carefully made spigot unions, constructed so that no disturbance of the stream is introduced thereby. No appreciable error could be attributed to irregular rotation of the drum of the meter. Even at low velocities extremely steady velocities were indicated by the hot-wire anemometer. It is essential to employ water free from any dissolved coal-gas or similar gas in the meter as the indications of the hot-wire anemometer in the form described are extremely erratic in the presence of small quantities of coal-gas &c. The meter was therefore thoroughly washed out with water. The stream of air was derived from a gas-holder having a volume of 5 cubic feet. The pulley over which passed the supporting rope of the bell, the other end of which was weighted, was provided with a cam over which passed a rope carrying a compensating weight, so that the same pressure was maintained throughout the fall of the bell in its tank. Any desired pressure could be obtained by suitably weighting the bell. It was found that the desired constancy of pressure could be readily obtained by the use of this pressure device, without the introduction of any further pressure governors in the circuit. The precautions already detailed were taken to ensure the freedom of the water in the holder from any dissolved coal-gas. In calibration of the anemometer, air was passed through the apparatus, and the rate determined by observation of the pointer of the gas-meter, this observation extending over a period varying with the velocity of flow in the pipe, so that with low velocities the period of observation was proportionately longer. A length of about five feet of tube was situated on either side of the anemometer wires, and the internal surface was throughout the whole length of the same made as smooth as possible by polishing. Usually the whole length of tube was wrapped with asbestos cord. A number of fine copper gauzes was introduced into the flow-tube at G, so as to effect distribution of the current of gas across the section of the tube. The meter M was of the type customarily employed in the technical practice of gas measurement. It was made by Sugg, and one rotation of the drum corresponded to the passage of $1/12$ cub ft. of gas. This volume was adjusted accurately to the desired amount in the usual manner by the

use of the 1/12 cub. ft. bottle specified in the Notification of the Metropolitan Gas Referees. The volume could be adjusted with certainty to 1 part in 400, and with very little change from day to day. The movement of the indicating hand of the meter was very regular, even when revolving at extremely low velocities.

A definite current—in different experiments adjusted to values between 0.6 amp. and 1.5 amp.—was maintained in the bridge, the constant-ratio arm being adjusted to 1000 or 2000 ohms. The bridge was first balanced with zero flow of air, the current being adjusted to the specified value. The air current was now passed through the tube, and the deflexions of the galvanometer observed on both sides of the zero after adjustment of the current to its initial value. The galvanometer employed was either a unipivot pointer instrument by Paul of resistance 60 ohms, or a suspended-coil reflecting galvanometer whose sensitiveness was suitably adjusted by the use of shunts, or by the insertion of resistances in series with the coil. The general nature of the results was the same in all cases. The deflexion having been read, the drop of potential across the shielded wire was determined as already explained, and the bridge restored to balance by adjusting the resistance in the fourth arm of the bridge, the electric current being maintained constant throughout. The temperature of the air-stream was determined and likewise the temperature of the air in the gas-meter, and the barometric pressure. The excess pressure at the meter outlet was observed. In no case did this exceed 0.8 inch of water. The method of reducing the readings is determined by the fact that, as pointed out by King*, his own theoretical investigations, and the experiments of Kennelley and Samborn† show that the hot-wire anemometer measures the mass-flow of the gas. The readings of gas volumes were therefore throughout reduced to 0° C. and 760 mm. pressure. The necessary correction of velocity for pressure has been shown by King to be given by $\frac{dV}{V} = -\frac{dp_0}{\mu_0} \ddagger$, and for ordinary variations is negligible.

Amongst other disturbing factors which might affect the anemometer readings, mention may be made of the effect of variation of temperature and the transverse vibration of the wire upon the observed reading. Variations of temperature of the stream of fluid are not entirely eliminated by

* Phil. Mag., xxix. p. 570 (1915).

† Proc. American Phil. Soc., viii., (1914).

‡ King, Phil. Mag., *loc. cit.*

the compensating device employed. There is still a possible outstanding source of error due to the fact that the passage of heat from the wire to the stream of fluid is determined by the difference of temperature of the two. The bridge being of the constant current type, for ordinary variations of atmospheric temperature, this difference will be practically independent of the latter temperature, so that the correction necessary for variation in atmospheric temperature is, in any case, very small. In fig. 17 (Pl. XIII.) are plotted separated observations for two calibration curves, the mean temperature of the air stream in the one case being $20^{\circ}\cdot 2$ C. and in the other $17^{\circ}\cdot 9$ C. These are seen to be practically coincident. With regard to the vibration of the heated wire, the magnitude of the necessary correction can be deduced by the formula developed by King*. As the wire employed in the present experiments was not heated to a very elevated temperature, the maximum amplitude of vibration was small, of the order of 0.01 cm., and as, moreover, the experiments were confined to measurements at comparatively low velocities, the correction due to this cause was small. The correction due to conduction along the leads is reduced by the consideration that the distribution of velocities across the cross-section of the tube is such that the wire is cooled most at the centre and least at the wall of the tube. The investigations of King† have shown how the necessary correction can in any case be calculated, and he directs attention to the fact that no correction is necessary if the anemometer is employed under the same conditions of air velocity in the neighbourhood of the terminals of the wire as those ruling during calibration.

A preliminary series of experiments showed that the ratio of the resistance of the unprotected wire to that of the shielded wire was not constant for different values of the current in the bridge. The variation in the ratio is shown in Table I. It is seen that in the case of zero air-flow the ratio of the resistance of the unprotected wire to that of the protected wire increases with increasing current. This is no doubt partly due to the fact that the cooling of the protected wire is facilitated by the presence of the protecting sheath, an effect analogous to that described by Porter‡. This point will be returned to later. It will be observed from Table II. that the resistance of the protected wire was

* Phil. Trans. Roy. Soc. A. 520, pp. 214, 398 (1914).

† *Loc. cit.* p. 397.

‡ Phil. Mag., Sept. 1910, pp. 511-522.

TABLE I.

Current in Bridge.	Ratio :— $\frac{\text{Resistance of unprotected wire.}}{\text{Resistance of protected wire.}}$	
	Voltmeter not inserted across covered wire.	Voltmeter across covered wire.
0.02	0.983	0.983
0.2	0.983	0.985
0.3	0.988	0.990
0.4	0.992	0.995
0.5	0.997	1.000
0.6	1.000	1.004
0.7	1.002	
0.8	1.004	1.010
0.9	1.007	
1.0	1.012	1.020
1.1	1.019	
1.2	1.028	1.040
1.3	1.038	
1.4	1.048	1.061
1.5	1.057	1.070

constant when the intensity of the air-current passing over the sheath was varied, the bridge-current being maintained constant. The method of calibration is best illustrated by the consideration of the reduction of a set of observations as recorded in the laboratory record:—

Page 48. *Anemometer* No. 2 (a).

Length of wires.—Protected 2.0140 cm. } at 21° C.
 „ „ Unprotected 2.0066 cm. }

Mean diameter of unprotected and protected wire 0.00784 cm.

Temperature coefficient of unprotected wire = 0.00291.

$R_{17.5} = 0.282$ ohm, when $c = 0.01$ amp.

Mean diameter of tube 2.0534 cm.

Current 1.3 amp.

Dry air flowing in tube.

Ratio arm 1000 ohms.

the Hot-wire Anemometer.

TABLE II.

Air Stream.	Temperature.		Bar. Press.	Volume of Air saf. with Water Vapour passed p. hr.	Time of Obs.	Correct Vol. of Dry Air per hr. at 60° C. & 760 mm.	Deflexion of Galvanom.	Resistance.		Volt-meter Reading.	Protected Wire.	Unprotected Wire.
	° C.	° F.						Ohms.	Ohms.			
...	0	...	0	0	1042	1042	0.971	0.747	0.778
18.8	65.0	29.76	29.76	4.90	2	2.24	5.5	1042	1023	0.971	0.747	0.764
19.0	65.0	29.76	29.76	6.55	2	2.99	11.1	1042	1003	0.970	0.746	0.748
19.0	65.0	29.76	29.76	7.84	2	3.58	20.1	1041	973	0.970	0.746	0.726
19.4	65.5	29.76	29.76	9.78	2	4.46	30.5	1040	936	0.970	0.746	0.698
19.5	66.0	29.76	29.76	11.83	2	5.37	40.7	1040	902	0.970	0.746	0.673
19.6	66.0	29.76	29.76	14.20	2	6.45	50.7	1039	870	0.970	0.746	0.649
19.7	66.0	29.76	29.76	16.85	2	7.66	60.0	1039	839	0.970	0.746	0.626
19.9	66.5	29.76	29.76	20.50	2	9.31	70.2	1039	805	0.970	0.746	0.600
20.0	66.5	29.76	29.76	24.94	2	11.08	80.8	1039	771	0.970	0.746	0.575
20.2	66.5	29.76	29.76	31.0	2	14.08	91.0	1038	736	0.970	0.746	0.549
20.7	66.5	29.76	29.76	37.95	2	17.22	95.5	1038	705	0.970	0.746	0.526

These results, together with similar results obtained, forming a series in which bridge-currents equal to 1.1, 1.2, 1.3, 1.4, and 1.5 amp., are shown in the accompanying diagram (Pl. X. fig. 5). The abscissæ in the figure denote galvanometer deflexions, and the ordinates the number of cubic feet of air (at 0° C. and 760 mm.) passing per hour. These latter are readily converted to the corresponding values of the mean velocity of the air in the tube, in cms. per sec., by multiplying by 2.374. The relative sensitiveness of the anemometer employing various currents is seen from the diagram. In general, a more open scale of deflexions is secured at the higher velocities by employing a larger current. In all the curves, the existence of a point of inflexion is clearly seen. The existence of these points of inflexion is, of course, connected with the existence of what is termed the "free convection" current from the heated wire. The total cooling effect to which the wire is subjected is the resultant of the cooling effect due to the air current passing down the tube, and that due to a convection current of heated air rising from the wire. A mathematical investigation of the magnitude of the convection cooling effect has been made by King*, who has interpreted the experimental work of Langmuir† on the subject in the light of the results obtained. In the present experiments, the heated wire being fixed horizontally, the air-current and the free convection current are at right angles to one another, and the resultant cooling current to which the heated wire is subjected is equal to $\sqrt{V_a^2 + v_c^2} = V$, say, where V_a denotes the mean value of the velocity of the horizontal air stream, and v_c that of the "free convection" current. The value of v_c diminishes as the impressed velocity V_a is increased, owing to the lowering of temperature of the wire produced thereby. Assuming that the diminution of v_c is proportional to v_a or some positive power thereof, it follows that the free convection current will influence the form of the calibration curve at a higher impressed velocity, the higher the initial temperature to which the wire is raised, *i. e.* the larger the electric current employed. With a view to the investigation of the effect of the free convection current upon the form of the calibration curve, a series of experiments was carried out using currents 0.9, 1.1, 1.3, 1.4, and 1.5 amp., respectively, in conjunction using a reflecting galvanometer of resistance 60 ohms by

* King, Phil. Trans. *loc. cit.* p. 425.

† Langmuir, Phys. Rev. 1912, xxxiv. 415.

Paul, the galvanometer sensitiveness being appropriately reduced either by means of a shunt or by a resistance in series. The results obtained for the series in which the galvanometer was shunted throughout by a resistance of 6 ohms are shown in Plate X. fig. 6. Exactly analogous results were obtained when 1000 ohms was employed in series with the galvanometer. The results show that, in the region of low air-current velocities, where the effects of the "free convection" current are considerable, the sensitiveness of the anemometer is greater the smaller the heating current employed. Thus, examining the respective deflexions for the same air-current amounting to 1.5 cubic feet per hour, it is seen that the deflexion when a current of 0.9 amp. is employed is considerably greater than that when a current of 1.5 amp. is used in the bridge. The values of the deflexions for intermediate values of the current are seen to range between these two values, being greater the smaller the heating current employed. This inversion of the order of sensitiveness as related to the heating current employed, compared with what occurs when higher values of the air-current velocity are employed, is accounted for by the fact that the balance of the bridge "with zero flow" is effected under the influence of the "free convection" current. This "free convection" current is greater the larger the heating current employed in the bridge, and the proportional cooling effect due to any definite impressed velocity is, of course, smaller the larger the "free convection" cooling effect. The matter can be regarded mathematically thus:—The proportional change in the effective velocity of the cooling stream when a small velocity v due to the air-current is impressed upon the free convection current is

$$\frac{\sqrt{r_c^2 + v^2} - r_c}{r_c} = \frac{v^2}{2r_c^2}$$

This is greater, the smaller the value of r_c , *i. e.* the lower the temperature to which the wire is initially heated. A comparison of the curves for 0.9 amp. and 1.1 amp. shows that for higher velocities of the air-stream, the latter affords the greater sensitiveness. The point at which the inversion from the less to greater sensitiveness occurs, in the case of any two currents, is seen to occur at a greater velocity the greater the current employed. In the figure, the point of inversion of the relative sensitiveness has not been reached in the case employing values of the current 1.3 and

1.5 amp., but an examination of fig. 5 shows that such inversions do occur in this case also*.

In Plate X. fig. 7 the ordinates are proportional to the square root of the velocity of the air-current. It is seen that in every case there is a region over which the graph is a straight line, the extent of this straight portion being greater the larger the current employed. In the case employing a current of 1.5 amp., this straight-line portion is seen to extend over the region included between the points P and Q. The curves become concave towards the axis of deflexions in the region of the origin, the value of the deflexion at which this occurs being greater in proportion as the electric current employed is increased. The point at which this occurs has not been attained in the case where a current of 1.1 amp. was employed. The straight portion of the several graphs is succeeded by a portion convex to the axis of deflexion. With the use of still larger electric currents, within the limit of destruction of the filament, the straight portion can be considerably extended.

The resistance of the exposed wire was determined in every case when exposed to the various air-currents, the electric current in the bridge being adjusted to its appropriate value when balance of the bridge was restored by unplugging resistances from the box. The resistance of the protected arm is immediately calculated from a knowledge of the drop of potential occurring across it, and the resistance of the exposed wire calculated therefrom in the usual manner. The results obtained are shown in Plate XI. fig. 8. It will be observed that the effect of the free convection current is very pronounced at the lower velocities, and that, moreover, the velocity at which the change of curvature of the respective graphs occurs is greater the larger the heating current employed. In Plate XI. fig. 9 the abscissæ represent resistances, and the ordinates are the logarithms to base 10 of the volumes of air passing through the pipe measured in cubic feet per hour. It is seen that within the range of mean gas velocities employed, and where the effect of the free convection is small, if V denote the volume of air passing through the pipe in cubic feet per hour, and R the resistance of the wire, the relation between V and R is, outside the region of low velocities where the effect of the free convection current is of importance, of the form:—

$$R = a - b \log_{10} V.$$

* Although the curve for $c=1.4$, as shown, cuts the curve for $c=1.5$ before that for 1.3 cuts the latter, it is evident that such order of cutting may be attributable to experimental error.

The table herewith gives the values of a and b for the various values of the electric current employed :—

TABLE III.

Current. C (amps.).	$R = a - b \log_{10} V.$
1.1	$R = 0.6556 - 0.1816 \log_{10} V.$
1.2	$R = 0.7642 - 0.2345 \log_{10} V.$
1.3	$R = 0.8866 - 0.2932 \log_{10} V.$
1.4	$R = 1.0140 - 0.3467 \log_{10} V.$
1.5	$R = 1.1315 - 0.3850 \log_{10} V.$

If, instead of expressing the results in terms of the volume of air passing through the pipe, results are expressed in terms of the mean velocity v in cms. per sec. of the air across the section of the pipe, then the relations assume the forms :—

TABLE IV.

Current. C (amps.).	$R = a - b \log_{10} v.$
1.1	$R = 0.7238 - 0.1816 \log_{10} v.$
1.2	$R = 0.8522 - 0.2345 \log_{10} v.$
1.3	$R = 0.9967 - 0.2932 \log_{10} v.$
1.4	$R = 1.1442 - 0.3467 \log_{10} v.$
1.5	$R = 1.2760 - 0.3654 \log_{10} v.$

In Plate XIII, fig. 10 the respective values of a and b in the relation $R = a - b \log_{10} V$ are plotted against the respective values of the electric current as abscissæ. The relation of a and of b respectively to the number of cubic feet of air flowing per hour in the tube is seen to be a linear one in each case. The relation of a to V is given by

$$a = 1.172 C - 0.6361,$$

and that of b to C is :

$$b = 0.5040 C - 0.3670,$$

so that, R the resistance of the wire is related to the electric current flowing in the wire, and the current of air V flowing in the pipe, expressed in cubic feet per hour, by the relation :—

$$R = (1.172 C - 0.6361) - (0.5040 C - 0.3670) \log V.$$

The expression for the resistance of the wire in terms of the electric current, and the mean velocity of the air across

the section of the pipe, is readily obtained from the above, as already explained. It is seen therefore that, in general, within the range of values of the electric current employed, and within the range of mean velocities where the free convection effect is somewhat reduced, the resistance R of the wire is related to the current C and the mean velocity v by a relation of the form :—

$$\begin{aligned} R &= (\alpha C - \beta) - (\gamma C - \delta) \log v \\ &= C(\alpha - \gamma \log v) - (\beta - \delta \log v), \end{aligned}$$

where α , β , γ , and δ are constants readily determined experimentally.

In the preceding experiments, the heated wire was mounted horizontally, and the pipe itself was horizontal. In order to study the magnitude of the free convection current, the pipe was now placed vertically, the heated wire being still horizontal. Arrangements were made whereby the current of dry air could be passed over the heated wire in the pipe either in an upward or downward direction. In the former case, if V_a denote the impressed velocity of the air stream at any part of the wire, and v_c the velocity of the upward-flowing free convection current therefrom, it is obvious that in the one case the effective velocity of the air-current is $V_a + v_c$ and in the other $V_a - v_c$. The method of carrying out the series of experiments was exactly similar to that detailed above. The pipe in which the air flowed was set up vertically and had a total length of 5 feet. Gauzes were arranged close to the entrance to the pipe to distribute the stream across the section of the pipe. When the gas flowed in a downward direction, it was found that disturbing effects were reduced to a minimum by passing the air from the flow-pipe through a wide glass tube bent twice at right angles and of length about 30 inches. The exit limb of this tube was arranged vertically, and the gas passed therefrom in an upward direction. It was found impossible to secure the very steady electrical conditions with low values of the velocity of flow, such as could be obtained when the flow-tube was arranged horizontally. The spot of light in general oscillated from 2 to 5 divisions on either side of the equilibrium position, the maximum deflexion obtained in the present series of observations being about 500 divisions. In all cases, however, where the velocity of flow exceeded a certain value, which varied with the electric current employed, and was greater the greater the electric current employed, the readings were extremely steady. With velocities in excess

of these critical values, the hot-wire anemometer can be employed equally well with streams flowing in an upward or downward direction, as is the case with horizontal streams. In the latter case, however, the steadiness of readings is remarkable throughout the whole range of velocities, and wherever possible hot-wire anemometers should be installed in horizontal streams rather than in vertical streams of gas. Morris* employed a hot-wire anemometer immersed in a downward-flowing stream of air, and with regard to its calibration remarks: "an unstable part of the curve will be noticed at a velocity of perhaps half a mile an hour; this is probably due to the unstable way in which the upward gentle natural convection current is met by the downcoming air-current due to the fan." The author's experience leads him to believe that this instability is less when the air-current is directed upward than when directed downward, although even then there is still some little instability of reading, but the instability disappears at a lower velocity of the air-current than in the case of a downwardly directed flow of air. The instability with vertical air-current is not to be attributed entirely to the difference in the velocity of the air-current at different points in the cross-section of the pipe, as this condition also holds in the case of the horizontal flow experiments where remarkably steady readings are obtained, and, as pointed out, the instability is also present in Morris's experiments carried out in a wind channel. It is of interest to note that in the case of variable velocity across the section, as in the case of flow in a pipe, as the stream flow decreases towards the boundary of the pipe the cooling of the wire due to the stream necessarily diminishes in the same direction. The free convection current therefore increases from the centre towards the boundary of the pipe. The result, therefore, is that, in the case of an upward air-stream flowing in the pipe, the possible difference of temperature existing in the wire at the centre and boundary is diminished by the existence of the free convection current, the opposite effect being produced in the case of a downwardly directed air-current. The diminished instability in the case of an upwardly directed current of air, compared with that in the case of a downwardly directed current, is probably largely due to this cause. It seems probable that the instability present in the case of a vertical flow is partly due to the fact that the vertical tube is subjected throughout its length to the varying conditions of the surrounding atmosphere. It

* British Assoc., 1912; Engineering, Dec. 27th, 1912.

was found that the effect was somewhat reduced, though not entirely eliminated, by providing the tube with a double lagging of thick asbestos cord throughout its length. The general instability was greater the larger the heating current employed, and on this account it was not possible to employ the whole of the heating currents employed in the present series. Experiments were, however, carried out employing currents of 0.6, 0.8, 0.9, 1.0, 1.1, and 1.2 amp. respectively in the bridge. The sensitiveness of the galvanometer was suitably adjusted in each case, so that the maximum possible deflexion occurred with a *downward* flow of air of about 4 cub. ft. per hour. Low rates of flow were alone examined, and the results for downward flow of air are shown in Plate XI. fig. 11. Owing to the varying sensitiveness of the galvanometer employed, the various series of deflexions are not strictly comparable one with another. The results in the case of 0.6 amp. and 0.7 amp., however, are strictly comparable, as are likewise those for 1.1 and 1.2 amp. respectively. In every case it was found that on increasing the air-flow gradually from zero, the deflexion first increased, attained a maximum value, and then decreased until zero deflexion was again reached. Thereafter the deflexion was reversed and increased continuously. Comparing the results for 0.6 and 0.7 amp., it will be seen that, initially, the bridge employing the larger current is more sensitive than that employing the smaller. Ultimately, however, a point is reached at which the inversion of the relative sensitiveness occurs, the smaller current then affording the greater sensitiveness. This is clearly seen by considering the respective deflexions corresponding to flows amounting to 0.4 and 1.8 cubic feet per hour. The respective points at which the maximum deflexions occur on the left of the origin are indicated by P, Q, R, S, T, U, V. The significance of these points is obvious. The maximum deflexion occurs when the cooling effect due to the free convection current is exactly negated by the downward flow of air. We may therefore conclude that the velocity of the free convection current from the wire at the appropriate temperature is in any given case equal to the mean velocity of the air-stream at which the maximum deflexion occurs. Considering the portion of any one of the curves to the left of the axis of volumes, it is seen that the ordinate through any deflexion such as -100 cuts the curve in two points. These two points represent a condition of affairs in which the temperature of the wire is the same. The free convection current from the wire is therefore the same, v_c say.

In the case of the smaller impressed velocity v_1 , the effective cooling velocity is $v_c - v_1$, and with the larger impressed velocity v_2 , the effective cooling velocity is $v_2 - v_c$. As the wire is brought to the same temperature by these two effective velocities, we have, numerically, $v_c - v_1 = v_2 - v_c$, i.e. $v_c = \frac{v_1 + v_2}{2}$.

The free convection current corresponding to any deflexion to the left of the axis of volumes is thus seen to be represented by the point midway between the two points at which the curve is cut by the ordinate through that deflexion. This affords an accurate means of determining the exact positions of the points P, Q, R, &c., and also enables the variation with temperature of the free convection current to be very accurately determined. The temperature of the wire corresponding to any deflexion to the left of the axis of volumes increases as the deflexion increases. The free convection current from the wire therefore increases in the same direction. Bearing in mind how the free convection current is determined from the curve, this fact explains the want of symmetry of the respective curves about the horizontal lines through P, Q, R... respectively. The upper half is blunt compared with the lower half, as the lines joining the mid-points referred to above slope upwards to the left. In particular, reference may be made to the fact that the length of ordinate intercepted at the origin represents twice the free convection current from the wire in the absence of any impressed velocity. In Plate XII. fig. 12 are given the form of the air-flow deflexion-curves for values of the electric current equal to 0.6 and 1.1 amp. respectively, in the case both of an upward and downward air-current. The galvanometer shunt was different in the case of the two currents employed. The curves for other values of the electric current ranging from 0.6 to 1.2 amp. are omitted for the sake of clearness. They all show the same characteristics as those illustrated. The characteristics of the portions of the curves to the left of the axis of volume have been already discussed. To the right of this axis, it is seen that, for the same value of the electric current, commencing with a maximum difference between the respective ordinates for upward and downward flow corresponding to zero deflexion, the difference thereafter continuously diminishes, the curves approaching more nearly with increasing flow in the tube. This approach is attributable to the fact that corresponding to an impressed velocity V_a of the air-stream, the actual velocity in the neighbourhood of the wire is in the case of the upwardly directed stream $V_a + v_c$, while in the case

of the downwardly directed stream the effective cooling velocity is $V_a - v_c'$, where v_c and v_c' are the appropriate velocities of the free convection current in the two cases. Were the wire maintained throughout the series of experiments at the same temperature, then v_c would be equal to v_c' , and the difference of the respective ordinates corresponding to the same deflexion would be a measure of twice the free convection current appropriate to the temperature in question. To the right of the axis of ordinates, the two curves would in that case be parallel. In the present case, however, v_c is necessarily less than v_c' , and both diminish with increasing velocity of the impressed air-current. The difference of the ordinates corresponding to any definite deflexion being proportional to $v_c + v_c'$ therefore necessarily diminishes with increasing deflexion, and the approach of the respective curves to one another is to be attributed to this fact. Evidence will be given later that this difference of ordinates persists with comparatively high values of the impressed velocity of the air-current.

In Plate XII. fig. 13 are shown the values of the resistance of the wire for upward and downward flow, the wire being heated by electric current of values ranging from 0.6 amp. to 1.2 amp. In the case of the downward streams, the resistance in each case attains a maximum value which occurs when the cooling of the wire by the free convection current is neutralized by the effect of the impressed air-stream. Utilising the results shown in fig. 12 and fig. 13, we are able to determine the velocity of the free convection current from the wire at various temperatures. The temperature* of the wire is deduced from its maximum resistance in every case (points P, Q, R, S, T, U, V, fig. 13), and the respective values of the free convection currents from the similarly marked points in fig. 12. The temperatures have been reduced to the scale of the nitrogen gas thermometer, by employing the correction table for $\delta = 1.50$ given by Harker (Phil. Trans. 1904). The resistance of the wire when conveying a current 0.01 amp. at 17.5°C . was 0.2820 ohm, giving a value of $R_0 = 0.2683$ ohm. The diameter of the wire employed was 0.00784 cm. The results obtained are shown in Table V., the velocities of the free convection

* Owing to war conditions prevailing at the time, the author was unable to obtain a sample of platinum wire of the purity usually employed in platinum thermometry. The sample of wire employed was declared by Messrs. Johnson and Matthey to be of the purity 99.5 per cent. Its temperature coefficient was 0.00291, and this value has been employed in deducing the temperature of the wire.

currents being calculated on the assumption that the temperature of the ascending convection current is the same as that of the wire.

TABLE V.

Heating Current.	Temperature of Wire.	Velocity of free Convection Current.
amp.	° C.	cms. per sec.
0.6	135	3.1
0.7	191	4.0
0.8	245	5.4
0.9	315	7.0
1.0	420	9.1
1.1	535	12.2
1.2	677	15.9

From a comparison of these values with the values of the free convection current as calculated by King* for wires of diameters 0.00691 cm. and 0.01262 cm., on the basis of Langmuir's † observations, it is seen that the present experimentally determined values for the velocities agree within the limits of estimated experimental error with the calculated values.

The Double Exposed Wire Anemometer.

A calibration curve was obtained employing two flow-tubes set up in a vertical position adjacent to one another. An exposed anemometer wire was inserted as already explained in each flow-tube. Owing to the close juxtaposition of the tubes, the employment of subsidiary shielded temperature-correcting wires was unnecessary. The two exposed anemometer wires were made from the same sample of wire, and were adjusted as nearly as possible to the same resistance. They constituted two arms of a Wheatstone bridge, the other two arms of which were formed of resistances unplugged from the resistance-box. One of these latter was made equal to 2000 ohms throughout the experiments, and the other adjusted so that balance of the bridge was obtained when no air-flow was established in the flow-tubes, the bridge-current being adjusted to 1.0 amp. The flow-tubes were connected in series, and the air-current passed upward through one tube and downward through the other. Now, with this arrangement the effective velocity

* Phil. Trans., *loc. cit.* p. 424.

† Langmuir, *loc. cit.* p. 415.

of the cooling current of air in the upward flow tube will be $V_a + v_c$, where V_a is the impressed velocity of the air-current and v_c the velocity of the free convection current from the wire. In the downward-flowing tube, the effective velocity is $\pm(V_a - v_c')$, where v_c' is the velocity of the free convection current from the anemometer wire therein, the + or - sign being chosen according as V_a is greater or less than v_c' respectively. A little consideration will show that for all values of V_a , the galvanometer deflexion due to an impressed air-velocity V_a in the anemometer tubes is that due to a velocity equal to the difference between $v_c + v_c'$ and its initial value. The deflexions respectively due to effective currents $V_a + v_c$ and $V_a - v_c'$ in the anemometer tube are shown by the curves for upward and downward flow in fig. 12, and the resultant deflexion corresponding to any value of the air-flow, with a pair of anemometer tubes employed as explained, is obviously represented by the horizontal distance between the points on the respective upward and downward flow curves corresponding to the air-flow in question. The actual calibration in the present case confirms this theory. The deflexion of the galvanometer increases with increase of the impressed air-flow starting from zero, attains a maximum value, and thereafter decreases. The maximum air-flow in the present experiment corresponded to the passage of 23.7 cubic feet of air per hour, and the deflexion of the suspended coil galvanometer shunted with 20 ohms, 2000 ohms being unplugged in the constant ratio arm, was 55 divisions on the scale. It is obvious, therefore, that at the velocity corresponding to this relatively high flow, and the correspondingly low temperatures of the wires, the effect of the free convection current is quite appreciable on the form of the calibration curve. A consideration of the curves for upward and downward flow in fig. 12 and others affords an immediate explanation of the characteristics of the calibration curve obtained in the present case. The horizontal distance between points on the respective upward and downward flow curves increases from zero with increasing air-flow, attains a maximum, and thereafter diminishes in accordance with the experimental result obtained. This form of double exposed wire anemometer is especially suitable for use with low velocities, owing to the increased sensitiveness obtained by its use. The instability apparently inherent to all hot-wire anemometers employed with vertical flow-tubes is somewhat reduced, though not entirely eliminated, and stability of deflexion is certainly secured at a lower velocity than that characteristic of a single flow-tube anemometer employed in a vertical position.

Double Exposed Wire Directional Anemometer.

This type of anemometer was introduced by the author* for indicating the direction of flow of gases in pipes. As shown in fig. 14, this type of anemometer consists of two

Fig. 14.

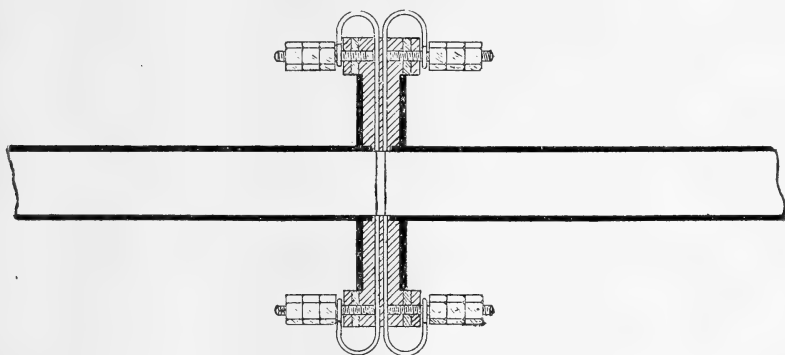

fine platinum wires, parallel to one another and separated by about 0.5 mm. They are inserted into the flow-tube in the manner already described, so that the wires are at right angles to the direction of flow of the gas-stream. The wires form two arms of a Wheatstone bridge, the bridge being completed in the manner already explained. As before, a constant current is maintained in the bridge. The indications of the anemometer depend upon the fact that the heated wire, upon which the gas-stream is first incident, exercises a shielding influence upon the cooling effect experienced by the second wire, the gas incident upon the latter having been already somewhat heated by passage over the first wire. It is obvious, therefore, that the direction of deflexion of the galvanometer will be to right or left, according to the direction of flow of the gas in the tube. Such an anemometer constitutes probably the most symmetrical type as regards free convection current that it is possible to realise experimentally. The temperature compensation in the bridge is all that can be desired, the wires being so closely apposed, and being both exposed to the stream without any separate shielding device. Calibrations of a directional anemometer of this type were made with the flow-tube arranged vertically and horizontally. With a vertical flow-tube, the air-stream was directed in a downward and in an upward direction in separate experiments. The

* Journ. Soc. Chem. Ind. xxxvii. pp. 165 T-170 T (1918).

calibration curves are shown in Plate XII. fig. 15, the ratio arm employed in the bridge being 2000 ohms, and the suspended coil galvanometer shunted with 12 ohms resistance. In the case of this type of anemometer employed with either an upward or downward flowing current of air, there is, as in other cases, a region of comparative instability corresponding to the portions of the calibration curves extending from zero flow to a flow of about 2.5 cubic feet per hour. Thereafter the readings obtained are remarkably steady. The steep inclination of the succeeding part of each curve shows that very high rates of flow of the gas would be necessary before the instrument would cease to function efficiently as an indicator of direction of flow. A deflexion of 248 divisions was obtained with a rate of flow corresponding to the passage of 25.4 cubic feet of air per hour, the flow-tube being mounted horizontally. With a horizontal flow-tube, owing to the symmetrical nature of the bridge, the zero remains extremely constant for various values of the heating current, and no adjustment of the balancing resistance in the bridge was found necessary during a series of calibrations. For the investigations of low velocities, this type of double-wire anemometer possesses a further advantage over the type employing one exposed wire and a second provided with a protecting shield. The great sensitiveness of the double-wire type at low velocities when used with horizontal flows is shown by the appropriate curve in fig. 15. An examination of the variation of the values of the resistances of the respective exposed wires with varied rates of flow showed that while that of the wire first meeting the air current diminished continuously from 0.5619 ohm to 0.4160 ohm, with increasing rate of flow from zero to 23.95 cubic feet per hour, under similar conditions that of the second wire *increased* from the value 0.570 ohm with zero flow to 0.594 ohm, corresponding to flow of 1.702 cubic feet per hour, thereafter diminishing continuously to the value 0.450 ohm, corresponding to a flow of 23.95 cubic feet per hour. The explanation of this phenomenon is as follows. By its passage over the first wire the air in the immediate neighbourhood of the wire is heated, and this heated air being transferred to the neighbourhood above the second wire reduces the natural convection loss from the latter. Some heat is of course convected from the latter by the stream of air, but on balance, the resistance of the latter wire increases, and such increase becomes greater for small values of the flow as the velocity of the flow is increased, owing to the fact that with such greater flow more heat is transferred from the first wire

to the neighbourhood of the second, and, moreover, this heated current of air suffers less fall of temperature in transit from one wire to the other, on account of the diminished time of transit. With still larger rates of flow, the cooling effect due to the stream more than counterbalances the increase of temperature due to convection of heat from one wire to the other, and thereafter the resistance of the second wire falls. It is clear, therefore, that for low velocities of flow, owing to the heating of the second wire as explained above, a double exposed wire anemometer of this type may be a far more sensitive instrument than the type in which the second wire is provided with a protecting shield so that it experiences no heating or cooling from the stream of air. This point is discussed in detail in the Proceedings Phys. Soc. 1920.

*Use of the Hot-wire Anemometer with Gases other than Air ;
the Glass-coated Hot-wire Anemometer.*

The measurement of the velocity of a stream of air in a pipe, although frequently occurring in technical practice, is by no means that most frequently called for, at least not in the author's experience. The hot-wire anemometer in the original form described on pp. 505-507 can be readily applied to the case of the anemometry of gases, such as CO_2 , N_2 , O_2 , etc., which are not adsorbed by the heated platinum wire nor catalytically decomposed thereby. The use of a bare heated platinum wire, particularly if the temperature is somewhat elevated, is practically impossible with a gas such as hydrogen, carbon monoxide, and gaseous mixtures such as coal-gas, etc. The readings obtained in such cases are extremely unsteady and unreliable. The sphere of usefulness of the hot-wire anemometer is considerably extended by employing as the sensitive wire a fine platinum wire on to which is fused a fine coating of glass*. This is easily effected by drawing down a piece of glass tube so that it is very fine in the wall, and so that its internal diameter is very slightly in excess of the wire. The glass is slipped over the wire, and can then, with practice, be readily fused on to the wire so as to form a surprisingly uniformly thick coating by heating the two cautiously in a small blowpipe flame to just past the softening point of the glass, care being exercised that the glass is not heated to too high a temperature and not exposed to the elevated temperature for such a length of

* Thomas, Journ. Soc. Chem. Ind., *loc. cit.*

time as to cause the glass to break up into a number of separate droplets—a tendency on the part of the softened glass, which is explained by well-known considerations relating to surface-tension phenomena. The fusing of the glass on to the wire can also be readily effected by heating the glass and wire cautiously to a predetermined temperature in a small muffle. Thereafter the wire and coating are annealed cautiously, and the wire aged in the usual manner by the passage of a current of about 2 amps. for some hours. An anemometer wire so prepared can be employed in the usual manner in gases such as hydrogen, methane, coal-gas, etc., and yields particularly steady and consistent results. Before passing to a consideration of the results obtained by the use of such an anemometer wire, and of an anemometer wire of the usual type in streams of air (dry and moist), carbon dioxide, hydrogen, nitrogen, and coal-gas, it is of interest to direct attention to a phenomenon differentiating the one type of wire from the other. It has already been remarked (see p. 511) that using an exposed uncovered anemometer wire, the resistance of this exposed wire increases more rapidly than that of the protected wire of the pair when the current through the wires is increased. The results obtained by the comparison of the resistance of the exposed wire with that of the shielded wire in the case of the bare wire and glass-covered anemometer wire are seen in Plate XIII. fig. 16, the results being given in the case of air for the bare wire anemometer and in the cases where the glass-coated wire is immersed in (1) air, (2) hydrogen, and (3) coal-gas. The wire employed was cut from the same specimen of wire as that employed in anemometer No. 2 (*a*), and had a diameter of 0.00784 cm. The mean diameter of the glass-coating was 0.08 cm. It will be seen that in the case of the bare wire surrounded by air, the resistance of the exposed wire increases with current more rapidly than that of the shielded wire with increasing supply of heat to the wire. With the glass-covered exposed wire in air, it is seen that, with increasing supply of heat to the wire, the resistance of the exposed wire decreases compared with that of the shielded wire, the ratio attaining a minimum value and increasing thereafter. With the glass-coated wire surrounded by coal-gas, the decrease in the ratio of resistances is still more marked, and attains a minimum value at a rate of supply of heat larger than is the case when the wire is surrounded by air. The result with hydrogen is similar to that in the case of coal-gas, the minimum value of the ratio being, however, smaller and occurring at a still higher value

of the rate of heat-supply. The difference of behaviour of the bare and coated wires when surrounded by air, so far as the increase in the ratio in the former case and the initial decrease in the latter, is explained by the simple theory explained by Porter *. It is recognized by Porter that the simple theory developed by him is inadequate to explain the whole of the phenomena observed in his work, and the discrepancies between the ratios of the temperatures of the bare and coated wires in his experiments is attributed to the variation of emissivity and thermal conductivity with temperature, and of emissivity with the radius of the wire. The results of Porter and the results obtained in the course of the present research can possibly be more rationally explained by a modification of Porter's fundamental equation, taking account of a possible additional heat loss $f(\theta_b)$ from the wire, proportional to some higher power than the first of the temperature difference between the wire and its surroundings, the fundamental equation given by Porter,

$$H = -k \cdot 2\pi r \frac{d\theta}{dr} = e \cdot 2\pi b \cdot \theta_b$$

becoming

$$H = -k \cdot 2\pi r \frac{d\theta}{dr} = e \cdot 2\pi b \cdot \theta_b + f(\theta_b),$$

According to King †, the free convection loss is given by $2\pi k_0 \theta_b [1 + c\theta_b] / [\log b/a]$ and is seen to include a term proportional to θ_b^2 , the square of the excess temperature of the wire. Looked at physically, the interpretation of the minima obtained with air, coal-gas, and hydrogen presents itself thus. So far as losses proportional to θ_b are concerned, the glass-coated wire loses heat more rapidly than the shielded wire. With small heating currents, the loss of heat $f(\theta_b)$ from both wires is small. As the temperature of the wires is increased the term $f(\theta_b)$ becomes of increasing importance and its value for the bare wire becomes greater than that for the glass-coated wire owing to its higher temperature. The point is reached at which the decreasing ratio of the resistances reaches a minimum; thereafter an inversion occurs in the decreasing ratio between the resistance of the coated wire to that of the shielded wire. This ratio then, instead of decreasing, increases owing to the greater loss of heat occurring from the shielded wire arising from the term $f(\theta_b)$. The occurrence of the minimum

* Phil. Mag., Sept. 1910, pp. 515-518.

† Phil. Trans., *loc. cit.* p. 403.

value of the ratio at higher values of the rate of heat-supply in the cases of coal-gas and hydrogen than is the case with air, is to be attributed to the relative effects in their cases of the loss proportional to θ_b being somewhat greater compared with their respective losses $f(\theta_b)$ than is the case with air. This is explainable in terms of the relative diathermancies, conductivities, specific heats, and densities of the respective gases, but it is unnecessary to pursue the point further here.

The results obtained for the calibration for a bare hot-wire anemometer in the cases of dry air (three results), air saturated with water vapour at atmospheric temperature (two results), carbon dioxide, and oxygen are shown in Plate XIII. fig. 17, the bridge-current being 1.3 amp. in each case. In Plate XIII. fig. 18 the results are given for the calibration of a glass-coated anemometer wire in streams of dry air, coal-gas, and hydrogen. The curves obtained with nitrogen using a bare wire anemometer were practically the same as those for air and are omitted from the diagrams for the sake of clearness. The curve obtained for the calibration of bare wire anemometer No. 2 in air using same current 1.3 amp. is added to fig. 18, for sake of comparison. The various gases passing through the flow-tube were sampled and their compositions ascertained with the following results:—

		per cent.
Sample of CO ₂	CO ₂	97.0
	O	0.5
	N (diff.)	2.5
Sample of N ₂	CO ₂	0
	O ₂	0.2
	N ₂	99.8
Sample of O ₂	CO ₂	0
	O ₂	96.0
	N ₂	4.0
Sample of H ₂	H ₂	99.8
Sample of Coal-gas	CO ₂	2.0
	O ₂	0.2
	CnHm	3.2
	CO	7.6
	CH ₄	30.5
	H ₂	48.0
	N ₂ (diff.)	8.5

An examination of the calibration curves given in fig. 17 shows that the deflexion corresponding to any constant flow of air was consistently a little greater when the air was dry than was the case when the air was saturated with water vapour at the temperature of the experiment. The difference in deflexion was of the order of from 0.5 to 1.2 per cent., and was obtained consistently in a series of experiments, two of which are shown in fig. 18. The difference is not attributable to the slight difference in pressure at the meter outlet in the two cases. King* was unable to detect any effect of variation of humidity upon his final readings. In the present series of experiments the variation of humidity was much greater than that recorded by King, and the result obtained shows that a variation of about 25 per cent. in the humidity of the atmosphere is the minimum that could influence the results in King's experiments. It is not stated whether such a variation occurred. The relative sensitivities of a glass-covered hot wire in air, hydrogen, and coal-gas when the same current is used in the bridge is shown in Plate XIII. fig. 18. The comparative insensitiveness in the cases of hydrogen and coal-gas is directly attributable to the much greater thermal conductivity of these gases compared with air. A reference to fig. 16 shows that with zero flow, employing an electric current equal to 1.3 amp., the resistance of the wire when in hydrogen is less than that when immersed in coal-gas, and very considerably less than when immersed in air. On this account, the initial temperature of the wire for zero flow was much less in the case of hydrogen and coal-gas than was the case with air. A fair basis of comparison of the respective sensitivities is only afforded when the wire immersed in the several gases has the same resistance in the absence of flow. The results in Plate XIII. fig. 17 enable a comparison of the thermal conductivities of the various gases detailed to be made. Expressions for the heat convected from the wire have been given by Boussinesq †, King ‡, and Rayleigh §. Boussinesq's expression, $H = 8(s\sigma kVa/\pi)^{\frac{1}{2}}\theta_0$, where s is the specific heat at constant volume of the gas, σ its density, and k is its thermal conductivity, V the

* Phil. Trans., *loc. cit.* p. 417.

† *Journal de Mathématiques*, 1. pp. 285-332 (1905).

‡ Phil. Trans., *loc. cit.* p. 381.

§ 'Nature,' xcv. p. 66 (1915). It may be remarked that the final expression given by Lord Rayleigh is obviously in error due to a misprint, and in place of $h \propto l\theta\sqrt{(bvc/k)}$ should read $h \propto l\theta\sqrt{(bvc)}$.

velocity of the stream, a the radius of the heated cylinder, θ_0 the temperature of the cylinder above that of the surrounding medium at a great distance, or the similar expression deduced by Rayleigh (see footnote on p. 531) is the type of expression most readily applicable to the present series of experiments. Considering the curves for air and carbon dioxide shown in fig. 17, it may be remarked that the resistance of the exposed wire under zero flow in the respective gases was 0.7906 ohm and 0.7869 ohm, so that the initial temperature of the wire in the two cases was very approximately the same. In the cases of oxygen and nitrogen, the initial temperatures were still more nearly equal to that in the case of air. Consider two points P and Q on the respective curves for carbon dioxide and air having the same value of the deflexion. The total heat convected from the wire is made up of that due to free convection from the wire, and that convected away by the stream. The respective resistances of the wire corresponding to the deflexion 100 (at this deflexion the proportional effect of free convection is the least in the present sequence of experiments) were 0.541 ohm in air and 0.536 ohm in carbon dioxide. The corresponding temperatures of the wire are 358°C . and 352°C . It is therefore legitimate to assume that for corresponding points P and Q on the same ordinate, the heat convection from the wire is very approximately the same in the two cases. The subscript ₁ referring to air, and ₂ referring to carbon dioxide, we have for points such as P and Q,

$$H_1 = H_2 = 8(s_1\sigma_1k_1V_1a_1/\pi)^{\frac{1}{2}}\theta_{01} = 8(s_2\sigma_2k_2V_2a_2/\pi)\theta_{02}.$$

Now, $\theta_{01} \approx \theta_{02}$; $a_1 = a_2$; and V_1 and V_2 are proportional to the respective ordinates at P and Q. We have therefore very nearly $s_1\sigma_1k_1V_1 = s_2\sigma_2k_2V_2$,

$$i. e. \quad \frac{k_2}{k_1} = \frac{s_1\sigma_1V_1}{s_2\sigma_2V_2}.$$

Before applying this relation it is essential to refer to the temperatures at which the respective values of s_1 , σ_1 , s_2 , σ_2 , are to be taken. Now the ratio $\frac{\sigma_1}{\sigma_2}$ remains practically unaltered over the possible range of temperatures employed in these experiments. The equipartition theory requires constancy of the ratio $\frac{s_1}{s_2}$. The ratio remains practically the same if values deduced from the quantum hypothesis are

used in the case of O, N, CO₂, air. The value of s_1 is given by Joly (1891) as $s_1 = 0.1715 + 0.02788\rho$, where ρ = density of the air in grms. per c.c., and $s_2 = 0.165 + 0.2125\rho + 0.34\rho^2$ (Joly, 1894). Applying the appropriate values of ρ , it is seen that it is quite sufficiently accurate to use the values $s_1 = 0.1715$ and $s_2 = 0.165$. We have therefore, since $V_1 = 87.5$ and $V_2 = 100.6$ (the numbers are relative and are taken from the diagram),

$$\frac{K_{\text{CO}_2}}{K_{\text{AIR}}} = \frac{1.293 \times 0.1715 \times 87.5}{1.977 \times 0.165 \times 100.6} = 0.591.$$

This ratio, and the similar ratios of conductivities in the cases of oxygen and nitrogen, are set out in the accompanying table, together with the values of the ratios at 0° C. and at 350° C., the ratios at 0° C. being experimental numbers derived from Winkelmann's observations, and those at 350° C. being calculated therefrom by means of O. E. Meyer's formula, $K = 1.603\eta_t c_v$, the value of η_t being calculated by means of Sutherland's formula*,

$$\eta_t = \eta_0 \frac{273 + c}{\theta + c} \left(\frac{\theta}{273} \right)^{3/2},$$

the values necessary for the calculations being all derived from Kaye and Laby's Tables.

TABLE VI.

Gases.	Values of Ratio of Conductivities.		
	Experimentally by Flow method.	At 0° C. from Winkelmann's observations.	Calculated at 350° C.
$\frac{K. \text{ Carbon dioxide}}{K. \text{ Air}}$ }	0.591	0.588	0.858
$\frac{K. \text{ Nitrogen}}{K. \text{ Air}}$ }	1.014	1.004	0.957
$\frac{K. \text{ Oxygen}}{K. \text{ Air}}$ }	0.909	1.078	1.091

* Phil. Mag. xxxi. (1893).

There is seen to be very close agreement between the values for the ratio in the cases of carbon dioxide, nitrogen, and air as determined experimentally by the flow method, and those calculated from Winkelmann's results at 0° C. The values do not agree with the calculated values of the ratios at 350° C. These results are explainable on the assumption of the existence of a very thin layer of stagnant gas surrounding the heated wire, the temperature gradient in such layer being great. This cylinder of gas then functions as the source of heat whence heat is directly transferred to the gas, and its effective temperature need only be slightly in excess of that of the gas-stream. In the case of oxygen and air, while the agreement between the experimentally determined values is not so close as in the other two cases, there is, however, fair agreement. The difference of 10 per cent. may be possibly attributable to the use of an uncertain value of the specific heat for oxygen at constant volume. The value employed has been deduced from Regnault's value of the specific heat at constant volume, taking $\gamma=1.40$.

The same method for the comparison of the thermal conductivities of the gases employed with the glass-covered anemometer wire cannot be used, as the temperature of the wire with zero flow when immersed in coal-gas etc. and in air was not sufficiently constant in the case of the various gases, and as, moreover, the observations with hydrogen etc. in this case were not carried out at sufficiently high velocities to render the theory valid.

This research was carried out at the Physical Laboratory of the South Metropolitan Gas Company, and the author desires to express his sincerest thanks to Dr. Charles Carpenter, C.B.E., for the ready provision of the facilities necessary for carrying out the work, and for permission to publish the same.

Physical Laboratory,
South Metropolitan Gas Co.,
709 Old Kent Road, S.E.
Dec. 18th, 1919.

L. *On a Mechanical Violin-Player for Acoustical Experiments.* By C. V. RAMAN, M.A., *Palit Professor of Physics in the Calcutta University**.

[Plate XIV.]

THE accompanying illustration (Plate XIV.) and brief description of a mechanically-played violin which has been developed after considerable experimentation and used in a series of studies of the acoustics of bowed stringed instruments may be of interest to readers of the *Philosophical Magazine*. The apparatus has been designed to reproduce as closely as possible the conditions obtaining in ordinary musical practice. A violin and a horse-hair bow of the ordinary type are used, and the object is to enable the strings to be bowed with accurately controlled and measurable pressures and speeds. Pressures ranging from one or two grammes weight up to a hundred grammes or more, and speeds ranging from one or two centimetres per second up to half a metre per second or more could be obtained and determined.

The arrangement differs from the ordinary playing of the instrument in that the bow itself remains stationary and the violin is caused to move to and fro with uniform speed. The light wooden cradle on which the violin is mounted rests on a brass slide which moves noiselessly to and fro along a well-oiled cast-iron track. The necessary movement is obtained as shown in the Plate by means of an endless chain which carries a pin working in a vertical slot attached to the brass slide. The chain is stretched taut between two free-wheels and is kept in movement by the rotation of one of the axles with fly-wheel and belt as shown in the Plate. By using a conical driving pulley on which the belt runs, various speeds of movement can be obtained. Very little power is of course required to drive the apparatus, but in order to obtain steady and uniform speeds over long intervals of time, it is advisable to use a shunt-wound motor with an ample margin of power running on little or no load in order to drive the apparatus. No special speed regulation will then be necessary.

The mounting of the bow demanded special attention in order that satisfactory results might be obtained. As can be seen in the Plate, it is attached to the end of a long wooden lath which is carefully balanced on an axle fitted with ball-bearings in order to secure the necessary solidity and freedom

* Communicated by the Author.

of movement. A weight hanging freely at the shorter end of the lever balances the weight of the lath and the bow. An adjustment is provided by which the bow may be held obliquely so that fewer or more hairs may be made to touch the strings. A vertical adjustment of the axle is also possible by which it can be arranged that the hairs of the bow when at rest touching the strings should be exactly parallel to the cast-iron track on which the cradle of the violin slides. (This is very important for the successful working of the apparatus.) The block carrying the axle can also be moved parallel to the strings of the violin with the aid of a screw, so that the distance between the bridge and the point at which the bow touches the string may be expeditiously altered. Finally, in order to check any movements of the lever carrying the bow which would result in fluctuations of its pressure, a damping arrangement is provided. A stout wire carrying a number of horizontal disks placed at intervals—hangs freely from the shorter arm of the lever and dips in a beaker of water or light oil. This device ensures a very smooth and uniform bowing of the string, and is found to be quite successful in practice. A rider can be placed at any desired point on the graduated longer arm of the lever and provides the necessary means of adjustment of bowing pressure. The observations of the tone of the instrument are always made when the violin is at or near the middle point of its stroke, and quite definite values may be obtained of the minimum pressure necessary under any given conditions in order to elicit a sustained tone with a strongly marked fundamental.

A considerable variety of investigations can be carried out with the aid of the mechanical player described above. As examples may be mentioned the study of:—(a) the relation between the bowing pressure and the position of the bowed point on the string; (b) the relation between bowing speed and bowing pressure; (c) the variation of bowing pressure with pitch, and the phenomena of the wolf-note; (d) the effect of using a "mute" on the bowing pressure; (e) the quantitative relation between tone-intensity and pitch for different types of instrument. A detailed description of the experimental results obtained on these points, and of the various other applications of the mechanical player, will be given in a forthcoming publication of the Indian Association for the Cultivation of Science.

Calcutta,
17th November, 1919.

LI. *The Dynamical Motions of Charged Particles.* By C. G. DARWIN, M.A., *Fellow and Lecturer of Christ's College, Cambridge* *.

1. **T**HE work of Bohr † and of Sommerfeld ‡ and others has given a new importance to problems connected with the orbits of an electron—in particular, to the effect on the orbits of the increase of mass with velocity. The first object of the present paper is to reduce the problem of the motion of any number of charged particles, moving at high velocities in any electric and magnetic field, to a Lagrangian form, so that all the well-known theorems of general dynamics may be made applicable. These principles are then applied to an example, the problem of two bodies; and, finally, as a matter of some theoretical interest (though it was never to be expected that the effect would be perceptible in practice), these results are applied, according to Sommerfeld's quantum principle, to calculate the small influence on the doublets of the hydrogen spectrum, due to the finiteness of mass of the nucleus of the atom.

The application of the methods of general dynamics to such problems is by no means new. Thus Sommerfeld makes much use of the canonical form in the solution of the orbits of a single electron, and much of Bohr's § later work is carried out with the Hamilton-Jacobi partial differential equation. Now the direct application to such problems of the canonical equations of motion implies a knowledge of the momenta corresponding to the various generalized coordinates, whereas in the formulation of any problem it is the velocities which are known and not the momenta. An exception occurs in the case of a single particle in a fixed electric field. Here the linear momentum is known to be $mv/\sqrt{1-v^2/C^2}$ ||, and the momentum corresponding to any other coordinate can be deduced by elementary methods. But even for a single electron a magnetic field upsets this rule, and in the case of several free electrons it is quite impossible to obtain the momenta *à priori*. In other words, for a general method of formulation, the Lagrangian must be found first, before it is possible to proceed to the Hamiltonian, and the Lagrangian, of course,

* Communicated by the Author.

† N. Bohr, *Phil. Mag.* vol. xxvi. pp. 1, 476, 857 (1913), vol. xxvii. p. 506 (1914), vol. xxix. p. 332 (1915), vol. xxx. p. 394 (1915).

‡ A. Sommerfeld, *Ann. d. Phys.* vol. li. p. 1 (1916).

§ N. Bohr, *Kgl. Dan. Vtd. Selsk.* 1918.

|| v the velocity, C the velocity of light, m the mass at low velocities.

will not have the simple connexion with the kinetic and potential energy that it has in ordinary dynamics.

It appears to me most probable that a great part of the theorems of general dynamics here given are already known, for the work of Sommerfeld and the later work of Bohr would be naturally based on them. But in the cases discussed by these writers the Hamiltonian form can be very quickly derived from first principles, and they make no mention of any general method of formulation, so that it seemed to me that it might be worth while to exhibit such a method. In developing this we can start either from Least Action or from modified Newtonian equations of motion. Least Action was shown by Maxwell to be applicable to the æther, and we should therefore only require to prove that the electric and magnetic forces in free space could be made ignorable by the addition of suitable terms for the particles. But this method involves distinctly more advanced dynamical principles, and so, in spite of its superior elegance, I have preferred to proceed by starting from the equations of motion, and have followed methods similar to those by which Lagrange's equations are introduced in dynamical text-books. In this way the problem is kept throughout as a problem of particles, and I hope it will be thereby made more accessible to those unfamiliar with the later developments of dynamics.

2. The problem is really one of relativistic dynamics, but no direct use will be made of the relativity transformations. If the mass of each particle is made the proper function of its velocity and if the electromagnetic equations are used in Lorentz's form *, then the motions described will be invariant for such transformations, and there is no need to go beyond a set of axes fixed in space and a fixed time-scale. This saves us from rather complicated considerations about relative velocity and acceleration.

When several particles are free to move, the difficulty of the problem lies in the fact that the force exerted by one of them on another depends on its position and motion at a certain previous time. In other words, we have to work with *retarded* potentials, and it will be seen that the effect of the retardation is of an order that is not negligible. It can only be calculated by approximation, and so it will be necessary to limit ourselves to motions where the velocities of the

* For the general principles of electromagnetic theory here used reference may be made to H. A. Lorentz, 'The Theory of Electrons,' but I use ordinary electrostatic units and not the Heaviside type.

particles are small, though not negligible, fractions of C , the velocity of light—that is, we shall expand in inverse powers of C . That it should be necessary to approximate is not surprising, as it is well known that according to the classical electromagnetic theory an accelerating electron will radiate, and the consequent dissipation of energy cannot possibly be represented by a Lagrangian form. The radiation of a single electron gives a reactive force on it of amount $\frac{2}{3} \frac{e^2}{C^3} \frac{d^2\mathbf{v}}{dt^2}$, where \mathbf{v} is the velocity vector. Hence

we must not expect to be able to find a Lagrangian accurate beyond the terms in C^{-2} . Though Sommerfeld's orbits are worked out without approximation, the neglect of the radiation terms implies that they are really only valid to this degree—that is, if they are regarded as based on the classical electromagnetic theory.

Now this raises quite unanswered questions of fundamental physics, for there can be no doubt that radiation does not really work in that way at all. But we have no right to claim that the equations with these radiation terms omitted will truly describe the motion simply because the radiation does not in fact occur; for quite apart from radiation there is something wrong with them. This is shown by the spiral orbits* which an electron should describe about a heavy nucleus, when its angular momentum is below a certain value. These orbits involve an ultimate coalescence of the electron with the nucleus, and if the theory were right they should be of fairly frequent occurrence, because, whatever the initial line of motion of the electron, a low angular momentum can always be attained by a sufficiently low initial velocity. This result follows whether the accurate or the approximate formula is used for the variation of mass. As there can be little doubt that coalescence does not in fact occur, it is necessary to invoke some modification of the laws of motion to prevent it, and the quantum naturally suggests itself. The question of these orbits in relation with the quantum has been discussed by Sommerfeld † to a certain extent, though the difficulties are not altogether removed and as in most other applications of the quantum the actual physical motion is quite incomprehensible. But, however that may be, and whatever assumption is made, the type of orbit must be quite altered and the validity of our present methods destroyed. So it is safer to claim validity for our

* C. G. Darwin, *Phil. Mag.* vol. xxv. p. 201 (1913).

† *Loc. cit.*

work only in cases where the velocities are and remain fairly small fractions of the velocity of light. In this way the spiral orbits will be excluded and the approximation to terms in C^{-2} will represent the facts as closely as is required. This limits our method to the problems of spectroscopy, and cuts out such interesting questions as the collisions of high-speed β particles.

3. The variability of mass of an electron is usually deduced from considerations of electromagnetic momentum. It is found that the linear momentum is $\frac{mv}{\beta}$, where m is the mass for low velocities, v is the constant velocity, and

$$\beta = \sqrt{\left(1 - \frac{v^2}{C^2}\right)}. \quad \dots \quad (1)$$

By well-known arguments (which, however, cannot quite escape criticism) there follow the equations of motion of the type

$$\frac{d}{dt} \left\{ \frac{m}{\beta} \dot{x} \right\} = F_x, \quad \dots \quad (2)$$

where F_x is the total force on the particle in the x direction. The three equations of the type (2) form our starting-point.

The variability of mass is often expressed by considering the quantities m/β and m/β^3 as transverse and longitudinal mass respectively, but these expressions are in fact deduced from (2), and it is useless to put down the more complicated equations in terms of them and then retrace the steps of the argument back to (2). As long as the equations of motion are expressed in terms of rate of change of momentum, instead of mass acceleration, there is no need for the conception of longitudinal mass.

First consider the problem of a single particle of charge e_1 and mass m_1 in any field of electric and magnetic force, variable in time and place. Making use of the vector notation, let $\mathbf{r}_1 (= x, y, z)$ be the position of the particle. Let \mathbf{E} and \mathbf{H} be the electric and magnetic forces, ϕ and \mathbf{A} the scalar and vector potentials from which they are derived. Then

$$\mathbf{E} = -\Delta\phi - \frac{1}{C} \frac{\partial \mathbf{A}}{\partial t} \quad \text{and} \quad \mathbf{H} = \text{curl } \mathbf{A}, \quad \dots \quad (3)$$

and (2) becomes

$$\frac{d}{dt} \left\{ \frac{m_1}{\beta_1} \dot{\mathbf{r}}_1 \right\} = -e_1 \Delta\phi - \frac{e_1}{C} \frac{\partial \mathbf{A}}{\partial t} + \frac{e_1}{C} [\dot{\mathbf{r}}_1, \text{curl } \mathbf{A}], \quad \dots \quad (4)$$

where $\beta_1 = \sqrt{1 - \dot{\mathbf{r}}_1^2/C^2}$ in the same notation.

Let q_1, q_2, q_3 be three generalized coordinates defining the position of the particle. The components of \mathbf{r}_1 are then known functions of the q 's and $\frac{\partial \dot{\mathbf{r}}_1}{\partial \dot{q}} = \frac{\partial \mathbf{r}_1}{\partial q}$ for any component of \mathbf{r}_1 and any of the q 's.

Take the scalar product of (4) by $\frac{\partial \mathbf{r}_1}{\partial q}$.

Then

$$\begin{aligned} \left(\frac{\partial \mathbf{r}_1}{\partial q}, \frac{d}{dt} \frac{m_1}{\beta_1} \dot{\mathbf{r}}_1 \right) &= \frac{d}{dt} \left\{ \frac{m_1}{\beta_1} \left(\frac{\partial \mathbf{r}_1}{\partial q}, \dot{\mathbf{r}}_1 \right) \right\} - \frac{m_1}{\beta_1} \left(\frac{\partial \dot{\mathbf{r}}_1}{\partial q}, \dot{\mathbf{r}}_1 \right) \\ &= \frac{d}{dt} \left\{ \frac{m_1}{\beta_1} \frac{\partial}{\partial \dot{q}} \frac{1}{2} \dot{\mathbf{r}}_1^2 \right\} - \frac{m_1}{\beta_1} \frac{\partial}{\partial q} \frac{1}{2} \dot{\mathbf{r}}_1^2 \end{aligned}$$

and putting in the value of β_1 , this reduces to $\mathfrak{D}_q(-mC^2\beta_1)$, where $\mathfrak{D}_q \equiv \frac{d}{dt} \frac{\partial}{\partial \dot{q}} - \frac{\partial}{\partial q}$ the Lagrangian operator. The expression $-mC^2\beta_1$ has an obvious connexion with the "world line" of a particle in relativity theory.

The next term in the equation is

$$-e_1 \left(\frac{\partial \mathbf{r}_1}{\partial q}, \Delta \phi \right) = -e_1 \frac{\partial \phi}{\partial q} = e_1 \mathfrak{D}_q \phi.$$

For the remainder we simplify by writing out one component of the vector product,

$$\begin{aligned} [\dot{\mathbf{r}}_1, \text{curl } \mathbf{A}]_x &= \left(\dot{x} \frac{\partial \mathbf{A}_x}{\partial x} + \dot{y} \frac{\partial \mathbf{A}_y}{\partial x} + \dot{z} \frac{\partial \mathbf{A}_z}{\partial x} \right) \\ &\quad - \left(\dot{x} \frac{\partial \mathbf{A}_x}{\partial x} + \dot{y} \frac{\partial \mathbf{A}_x}{\partial y} + \dot{z} \frac{\partial \mathbf{A}_x}{\partial z} \right), \end{aligned}$$

and the second factor is $\frac{d\mathbf{A}_x}{dt} - \frac{\partial \mathbf{A}_x}{\partial t}$, where $\frac{d\mathbf{A}}{dt}$ denotes the total rate of change of \mathbf{A} at the moving particle. Thus

$$\begin{aligned} \frac{e_1}{C} \left(\frac{\partial \mathbf{r}_1}{\partial q}, -\frac{\partial \mathbf{A}}{\partial t} + [\dot{\mathbf{r}}_1, \text{curl } \mathbf{A}] \right) &= \frac{e_1}{C} \left(\dot{\mathbf{r}}_1, \frac{\partial \mathbf{A}}{\partial q} \right) - \frac{e_1}{C} \left(\frac{\partial \mathbf{r}_1}{\partial q}, \frac{d\mathbf{A}}{dt} \right) \\ &= -\frac{e_1}{C} \mathfrak{D}_q(\dot{\mathbf{r}}_1, \mathbf{A}). \end{aligned}$$

So the equations of motion can be derived from a Lagrangian

$$L = -m_1 C^2 \beta_1 - e_1 \phi + \frac{e_1}{C} (\dot{\mathbf{r}}_1, \mathbf{A}). \quad \dots \quad (5)$$

This expression is valid for any fields, including explicit dependence of ϕ and \mathbf{A} on the time. In the case of a constant magnetic field it is a matter of indifference what particular integral is taken in finding \mathbf{A} from \mathbf{H} . For the general value of \mathbf{A} is given by the addition of a term $\Delta\Omega$ to any particular value, where Ω is a function of x, y, z . This adds on to L a term $(\dot{\mathbf{r}}_1, \Delta\Omega) = \frac{d\Omega}{dt}$, and if Ω is any function of x, y, z and t whatever

$$\mathfrak{D}_q \frac{d\Omega}{dt} = \frac{d}{dt} \frac{\partial\Omega}{\partial q} - \frac{\partial}{\partial q} \frac{d\Omega}{dt} = 0, \quad \dots \quad (6)$$

so that the extra terms will be without effect on the equations of motion.

4. We next find the Lagrangian for a number of freely moving interacting particles. Suppose there is a second one of charge e_2 and mass m_2 at \mathbf{r}_2 . This particle is in motion, but at first we imagine it outside the dynamical system, that is we suppose \mathbf{r}_2 to be known in terms of the time. Then the motion of e_1 is governed by (5), where ϕ and \mathbf{A} are to be calculated from the position and motion of e_2 . The potentials are given by

$$\phi = \frac{e_2}{r + (\dot{\mathbf{r}}_2, \mathbf{r}_2 - \mathbf{r}_1)/C} \Big|_{\text{ret.}}, \quad \mathbf{A} = \frac{e_2}{C} \frac{\dot{\mathbf{r}}_2}{r + (\dot{\mathbf{r}}_2, \mathbf{r}_2 - \mathbf{r}_1)/C} \Big|_{\text{ret.}} \quad (7)$$

In these expressions $r^2 = (\mathbf{r}_2 - \mathbf{r}_1)^2$ and $(\dot{\mathbf{r}}_2, \mathbf{r}_2 - \mathbf{r}_1)/r$ is the component of velocity of e_2 away from e_1 . The quantities are all to have *retarded* values. If the effect reaching e_1 at time t , left e_2 at time $t - \tau$, we have

$$\begin{aligned} (c^2\tau^2 &= (-\mathbf{r}_1 + \mathbf{r}_2 - \dot{\mathbf{r}}_2\tau + \frac{1}{2}\ddot{\mathbf{r}}_2\tau^2 - \dots))^2 \\ &= r^2 - 2\tau(\dot{\mathbf{r}}_2, \mathbf{r}_2 - \mathbf{r}_1) + \tau^2\{\mathbf{r}_2^2 + (\ddot{\mathbf{r}}_2, \mathbf{r}_2 - \mathbf{r}_1)\} - \dots \end{aligned}$$

Solving by approximation we find

$$\tau = \frac{r}{C} - \frac{(\dot{\mathbf{r}}_2, \mathbf{r}_2 - \mathbf{r}_1)}{C^2} + \frac{r}{2C^3}\{\dot{\mathbf{r}}_2^2 + (\ddot{\mathbf{r}}_2, \mathbf{r}_2 - \mathbf{r}_1) + (\dot{\mathbf{r}}_2, \mathbf{r}_2 - \mathbf{r}_1)^2/r^2\}.$$

Substituting in (7) . . . (8)

$$\phi = \frac{e_2}{r} + \frac{e_2}{2C^2} \left\{ \frac{\dot{\mathbf{r}}_2^2 + (\ddot{\mathbf{r}}_2, \mathbf{r}_2 - \mathbf{r}_1)}{r} - \frac{(\dot{\mathbf{r}}_2, \mathbf{r}_2 - \mathbf{r}_1)^2}{r^3} \right\}, \quad \mathbf{A} = \frac{e_2 \dot{\mathbf{r}}_2}{C r}.$$

. . . (9)

The solution of \mathbf{A} is only carried to this degree, because of the further factor C^{-1} in L which multiplies it. Substituting in (5) we have

$$L_1 = -m_1 C^2 \beta_1 - \frac{e_1 e_2}{r} - \frac{e_1 e_2}{2C^2} \left\{ \frac{\dot{\mathbf{r}}_2^2 + (\ddot{\mathbf{r}}_2, \mathbf{r}_2 - \mathbf{r}_1) - 2(\dot{\mathbf{r}}_1, \dot{\mathbf{r}}_2)}{r} - \frac{(\dot{\mathbf{r}}_2, \mathbf{r}_2 - \mathbf{r}_1)^2}{r^3} \right\}.$$

Add to this the expression $-m_2 C^2 \beta_2 + \frac{d}{dt} \frac{e_1 e_2 (\dot{\mathbf{r}}_2, \mathbf{r}_2 - \mathbf{r}_1)}{2C^2 r}$.

The first term is without effect because it is a pure function of the time, the second by (6). The result is

$$L = -m_1 C^2 \beta_1 - m_2 C^2 \beta_2 - \frac{e_1 e_2}{r} + \frac{e_1 e_2}{2C^2} \left\{ \frac{(\dot{\mathbf{r}}_1, \dot{\mathbf{r}}_2)}{r} + \frac{(\dot{\mathbf{r}}_1, \mathbf{r}_2 - \mathbf{r}_1)(\dot{\mathbf{r}}_2, \mathbf{r}_2 - \mathbf{r}_1)}{r^3} \right\}. \quad (10)$$

From its complete symmetry (10) will also give the motion of e_2 when \mathbf{r}_1 is regarded as known in terms of the time. Thus the equations of motion of e_1 are $\mathfrak{D}_{\mathbf{r}_1} L = 0$ and of e_2 are $\mathfrak{D}_{\mathbf{r}_2} L = 0$. If q be any generalized coordinate involving both \mathbf{r}_1 and \mathbf{r}_2 we have

$$\mathfrak{D}_q L = \left(\frac{\partial \mathbf{r}_1}{\partial q}, \mathfrak{D}_{\mathbf{r}_1} L \right) + \left(\frac{\partial \mathbf{r}_2}{\partial q}, \mathfrak{D}_{\mathbf{r}_2} L \right) = 0,$$

as may be seen by writing out the values of $\mathfrak{D}_{\mathbf{r}_1}$ and $\mathfrak{D}_{\mathbf{r}_2}$ or directly from the covariance of the operator \mathfrak{D} for point transformations. Thus (10) is the Lagrangian for the simultaneous motion of the two particles, which can now be regarded as both belonging to the dynamical system.

The last term in (10) is only accurate to the terms in C^{-2} , so for the sake of consistency the first two should only be expanded to this degree. They are then of the form

$$-m_1 C^2 + \frac{1}{2} m_1 \dot{\mathbf{r}}_1^2 + \frac{1}{8C^2} m_1 \dot{\mathbf{r}}_1^4.$$

Thus we have the complete Lagrangian for any number of charged particles in any field in the form :

$$L_1 = \sum \frac{1}{2} m_1 \dot{\mathbf{r}}_1^2 + \sum \frac{1}{8C^2} m_1 \dot{\mathbf{r}}_1^4 - \sum e_1 \phi + \sum \frac{e_1}{C} (\dot{\mathbf{r}}_1, \mathbf{A}) - \sum \sum \frac{e_1 e_2}{r_{12}} + \sum \sum \frac{e_1 e_2}{2C^2} \left\{ \frac{(\dot{\mathbf{r}}_1, \dot{\mathbf{r}}_2)}{r_{12}} + \frac{(\dot{\mathbf{r}}_1, \mathbf{r}_2 - \mathbf{r}_1)(\dot{\mathbf{r}}_2, \mathbf{r}_2 - \mathbf{r}_1)}{r_{12}^3} \right\}. \quad (11)$$

The double summations are for each pair of particles counted once only.

Finally, re-writing (11) without the vector notation

$$L = \sum \frac{1}{2} m_1 v_1^2 + \sum \frac{1}{8C^2} m_1 v_1^4 - \sum e_1 \phi_1 + \sum \frac{e_1}{C} v_1 A_1 \cos \chi_1 - \sum \sum \frac{e_1 e_2}{r_{12}} \\ + \sum \sum \frac{e_1 e_2}{2C^2} \frac{v_1 v_2}{r_{12}} (\cos \psi_{12} - \cos \theta_1^2 \cos \theta_2^2), \quad (12)$$

where e_1 , m_1 , v_1 are the charge, mass, and velocity of the first particle ;

ϕ_1 and A_1 are the scalar and vector potentials at e_1 due to external fields ;

χ_1 is the angle between the line of motion of e_1 and the vector potential ;

r_{12} is the distance between e_1 and e_2 ;

ψ_{12} is the angle between their lines of motion ;

θ_1^2 is the angle between the line of motion of e_1 and the line joining it to e_2 .

There is a certain interest in knowing how far wrong the approximation (11) will be according to the classical theory. This is done by calculating the next term for τ in (8) and evaluating the corresponding terms in (9). These are then substituted in (5). The force on e_1 from e_2 is found to be

$\frac{2}{3} \frac{e_1 e_2}{C^3} \ddot{\mathbf{r}}_2$. Thus the total force on e_1 is $\frac{2}{3} \frac{e_1}{C^3} \sum e_s \ddot{\mathbf{r}}_s$. The

summation will include e_1 , as well as the rest, as this term is the reactive force of an electron's radiation on itself. From the point of view of generalized coordinates we have

$\frac{\partial \ddot{\mathbf{r}}}{\partial \dot{q}} = \frac{\partial \mathbf{r}}{\partial q}$, so that the equations of motion can be put in the

form $\mathfrak{D}_q L = \frac{\partial F}{\partial \dot{q}}$, where $F = \frac{1}{3C^3} (\sum e_1 \ddot{\mathbf{r}}_1)^2$. If F is neglected

altogether, it is easy to see that the ratio of terms omitted to those included is of the order v/C .

5. When the Lagrangian for any problem has been found, the transition to the Hamiltonian follows in the usual way.

We find the momenta $p = \frac{\partial L}{\partial \dot{q}}$ and solve for the \dot{q} 's in terms

of them. The Hamiltonian is then $H = \sum p \dot{q} - L$ expressed in q 's and p 's, and the equations of motion have the canonical

form $\dot{p} = - \frac{\partial H}{\partial q}$, $\dot{q} = \frac{\partial H}{\partial p}$. Thus if \mathbf{p}_1 be the momentum

corresponding to each component of \mathbf{r}_1 , it is easy to see that, extending the use of the vector notation, we have

$$H = \sum \frac{\mathbf{p}_1^2}{2m_1} - \sum \frac{\mathbf{p}_1^4}{8U^2 m_1^3} + \sum e_1 \phi - \sum \frac{e_1}{Um_1} (\mathbf{p}_1, \mathbf{A}) + \sum \sum \frac{e_1 e_2}{r_{12}} \\ - \sum \sum \frac{e_1 e_2}{2U^2 m_1 m_2} \left\{ \frac{(\mathbf{p}_1, \mathbf{p}_2)}{r_{12}} + \frac{(\mathbf{p}_1, \mathbf{r}_2 - \mathbf{r}_1)(\mathbf{p}_2, \mathbf{r}_2 - \mathbf{r}_1)}{r_{12}^3} \right\},$$

All the developments of general dynamics (such as the Hamilton-Jacobi partial differential equation etc.) follow at once, with the exception of such theorems as depend on the kinetic energy having a quadratic form.

For many problems it will be quicker to work in the Lagrangian form direct. When q_s does not occur explicitly

in L , we have an integral $\frac{\partial L}{\partial \dot{q}_s} = p_s$ a constant, and when

this coordinate is "ignored" the modified Lagrangian is $L' = L - p_s \dot{q}_s$. The energy integral will exist when the external fields ϕ and \mathbf{A} do not contain the time explicitly and

is then of the usual form $\sum \dot{q}_s \frac{\partial L}{\partial \dot{q}_s} - L = \text{const.}$ Applying

this to (11) we have the integral

$$\sum \frac{1}{2} m_1 \dot{\mathbf{r}}_1^2 + \sum \frac{3}{8} m_1 \dot{\mathbf{r}}_1^4 + \sum e_1 \phi + \sum \sum \frac{e_1 e_2}{r} \\ + \sum \sum \frac{e_1 e_2}{2U^2} \left\{ \frac{(\dot{\mathbf{r}}_1, \dot{\mathbf{r}}_2)}{r} + \frac{(\dot{\mathbf{r}}_1, \mathbf{r}_2 - \mathbf{r}_1)(\dot{\mathbf{r}}_2, \mathbf{r}_2 - \mathbf{r}_1)}{r^3} \right\} \\ = \text{const.} \quad \dots \quad (13)$$

The first two terms can be obtained either direct in the expanded form, or else from the fact that

$$\sum \dot{q}_s \frac{\partial}{\partial \dot{q}_s} (-\beta_1) + \beta_1 = \frac{1}{\beta_1} = \left(1 - \frac{\dot{\mathbf{r}}_1^2}{U^2}\right)^{-1/2},$$

agreeing with the known fact that the kinetic energy of an electron is mU^2/β .

6. We now apply these results to the "Problem of Two Bodies." Take $e_1 = -e$, $m_1 = m$ and $e_2 = E$, $m_2 = M$. The motion is supposed to take place in a plane and the particles

are at (x_1, y_1) (x_2, y_2) at any time. Then from (11) we have

$$\begin{aligned}
 L = & \frac{1}{2}m(\dot{x}_1^2 + \dot{y}_1^2) + \frac{1}{2}M(\dot{x}_2^2 + \dot{y}_2^2) + \frac{1}{8C^2}m(\dot{x}_1^2 + \dot{y}_1^2)^2 \\
 & + \frac{1}{8C^2}M(\dot{x}_2^2 + \dot{y}_2^2)^2 + \frac{Ee}{r} - \frac{Ee}{2C^2r^3} \left\{ r^2(\dot{x}_1\dot{x}_2 + \dot{y}_1\dot{y}_2) \right. \\
 & \left. + [\dot{x}_1(x_1 - x_2) + \dot{y}_1(y_1 - y_2)] [\dot{x}_2(x_1 - x_2) + \dot{y}_2(y_1 - y_2)] \right\}. \quad (14)
 \end{aligned}$$

The first transformation is

$$x_1 = X + M\xi / (M + m), \quad x_2 = X - m\xi / (M + m),$$

with similar expressions for y_1, y_2 . Then X, Y may conveniently be called the centroid, though except for low velocities it has none of the properties ordinarily associated with the name. Then

$$\begin{aligned}
 L = & \frac{1}{2}(M + m)(\dot{X}^2 + \dot{Y}^2) + \frac{1}{2} \frac{Mm}{M + m} (\xi^2 + \eta^2) \\
 & + \frac{1}{8C^2}(M + m)(\dot{X}^2 + \dot{Y}^2)^2 + \frac{1}{2C^2} \frac{Mm}{M + m} (\xi\dot{X} + \eta\dot{Y})^2 \\
 & + \frac{1}{4C^2} \frac{Mm}{M + m} (\dot{X}^2 + \dot{Y}^2) (\xi^2 + \eta^2) \\
 & + \frac{1}{2C^2} \frac{Mm(M - m)}{(M + m)^2} (\xi\dot{X} + \eta\dot{Y}) (\xi^2 + \eta^2) \\
 & + \frac{1}{8C^2} \frac{Mm(M^2 - Mm + m^2)}{(M + m)^3} (\xi^2 + \eta^2)^2 + \frac{Ee}{r} \\
 & - \frac{Ee}{2C^2r^3} \left\{ r^2(\dot{X}^2 + \dot{Y}^2) + (\xi\dot{X} + \eta\dot{Y})^2 \right. \\
 & \left. + \frac{M - m}{M + m} [r^2(\xi\dot{X} + \eta\dot{Y}) + (\xi\dot{X} + \eta\dot{Y})(\xi\xi + \eta\eta)] \right. \\
 & \left. - \frac{Mm}{(M + m)^2} [r^2(\xi^2 + \eta^2) + (\xi\xi + \eta\eta)] \right\}. \quad (15)
 \end{aligned}$$

As $r^2 = \xi^2 + \eta^2$, X and Y do not occur explicitly in (15), and so we have integrals

$$\frac{\partial L}{\partial \dot{X}} = p_x \quad \frac{\partial L}{\partial \dot{Y}} = p_y. \quad (16)$$

For considering quasi-elliptic orbits we naturally take $p_x=p_y=0$ for the integration constants. If this is not done it will be found that the modified Lagrangian deduced from (15), if expressed in polar coordinates, contains θ explicitly. Under these conditions the ordinary integral of angular momentum does not exist. But any such case could be worked out easily by taking $p_x=p_y=0$ and when the complete solution has been found, applying a linear relativity transformation to give the system the proper motion of translation. Such a transformation would be expected to introduce the time explicitly into the formulæ. So it appears that the angular momentum integral would be replaced by a complicated integral involving both θ and t . The study of such an integral might have an analytical interest, but it would appear that in any specified case where p_x does not vanish (and the same applies to motions of the particles which are not in a plane) the required results could be quickest attained by relativity transformations. Thus, in studying the collision of a moving electron with a stationary, we should work out the orbit with both moving in such a way that $p_x=p_y=0$, and afterwards apply the transformation which would reduce one of them initially to rest.

Taking $p_x=p_y=0$ in (16) we have equations of which the solution is

$$\begin{aligned} \dot{X} = & -\frac{1}{2C^2} \frac{Mm(M-m)}{(M+m)^3} \dot{\xi}(\dot{\xi}^2 + \dot{\eta}^2) \\ & + \frac{Ee}{2C^2 r^3} \frac{M-m}{(M+m)^2} [r^2 \dot{\xi} + \xi(\xi \dot{\xi} + \eta \dot{\eta})]. \quad \dots (17) \end{aligned}$$

Next form $L' = L - p_x \dot{X} - p_y \dot{Y}$. This is given by simply omitting \dot{X} , \dot{Y} from (15), since \dot{X} , itself of the order C^{-2} , occurs everywhere either squared or else multiplied by C^{-2} . In polar coordinates we then have

$$\begin{aligned} L' = & \frac{1}{2} \frac{Mm}{M+m} w^2 + \frac{1}{8C^2} \frac{Mm(M^2 - Mm + m^2)}{(M+m)^3} w^4 \\ & + \frac{Ee}{r} + \frac{Ee}{2C^2} \frac{Mm}{(M+m)^2} \frac{2\dot{r}^2 + r^2 \dot{\theta}^2}{r}, \quad \dots (18) \end{aligned}$$

where $w^2 = \dot{r}^2 + r^2 \dot{\theta}^2$. The integral of angular momentum is

$$\frac{Mm}{M+m} r^2 \dot{\theta} \left\{ 1 + \frac{1}{2C^2} \frac{M^2 - Mm + m^2}{(M+m)^2} w^2 + \frac{Ee}{C^2(M+m)} \frac{1}{r} \right\} = p \quad \dots (19)$$

and of energy is

$$\frac{1}{2} \frac{Mm}{M+m} w^2 + \frac{3}{8C^2} \frac{Mm(M^2 - Mm + m^2)}{(M+m)^3} w^4 - \frac{Ee}{r} + \frac{Ee}{2C^2} \frac{Mm}{(M+m)^2} \frac{2\dot{r}^2 + r^2\dot{\theta}^2}{r} = -W. \quad (20)$$

The integration constant is taken as $-W$, so that W may be positive for elliptic orbits. Following the usual procedure we eliminate the time between (19) and (20), and express the orbit in terms of θ and u , where $u=1/r$. The result is an equation of the form

$$\left(\frac{du}{d\theta}\right)^2 = \alpha u^3 - (1-\beta)u^2 + 2gu - k, \quad (21)$$

where

$$\alpha = \frac{Ee}{C^2(M+m)}, \quad \beta = \frac{E^2 e^2}{C^2 p^2} \frac{M^2 - Mm + m^2}{(M+m)^2},$$

$$g = \frac{Ee}{p^2} \frac{Mm}{M+m} \left(1 - \frac{W}{C^2} \frac{M^2 - Mm + m^2}{Mm(M+m)}\right),$$

$$k = \frac{2W}{p^2} \frac{Mm}{M+m} \left(1 - \frac{W}{2C^2} \frac{M^2 - Mm + m^2}{Mm(M+m)}\right).$$

The solution of this equation to the same order of approximation as before is

$$u = q + s \cos \lambda\theta + l \cos 2\lambda\theta, \quad (22)$$

where

$$\lambda = 1 - \frac{3}{2}\alpha g - \frac{1}{2}\beta,$$

$$q = g + \frac{3}{4}\alpha(3g^2 - k) + \beta g,$$

$$s^2 = g^2 - k + \alpha g(4g^2 - 3k) + \beta(2g^2 - k),$$

$$l = -\frac{1}{4}\alpha(g^2 - k).$$

The last three expressions cannot be much simplified, but

$$\lambda = 1 - \frac{E^2 e^2}{2C^2 p^2},$$

which is independent of the masses and depends only on the angular momentum. It is the same as Sommerfeld's result and implies an advance of perigee by $\pi E^2 e^2 / C^2 p^2$ each revolution. The term in l makes a slight increase in the radius at the apses, and a decrease at the ends of the latus rectum. The solution of the relative orbit is completed by finding the time from (19). The formula is complicated and of no special interest.

We next solve for the motion of the centroid. As X and Y are of the order C^{-2} , it will be sufficient to use large order values for ξ , etc. Then changing the independent variable to θ and making use of the known value of w^2 , (17) gives

$$\frac{dX}{d\theta} = -\frac{1}{2C^2} \frac{M-m}{(M+m)^2} \left\{ 2(Eeu - W) \frac{d\xi}{d\theta} - Eeu \left(\frac{d\xi}{d\theta} + \frac{\xi}{r} \frac{dr}{d\theta} \right) \right\},$$

and this is directly integrable in the form

$$X = -\frac{1}{2C^2} \frac{M-m}{(M+m)^2} (Eeu - 2W)\xi.$$

If a is the half major axis $a = q/(q^2 - s^2)$ and $W = Ee/2a$ and we have

$$X = -\frac{1}{2C^2} \frac{M-m}{(M+m)^2} \frac{Ee}{a} (r-a) \cos \theta. \quad \dots (23)$$

If the motion of the centroid is to be valid for many revolutions, we must replace $\cos \theta$ by $\cos \lambda\theta$. Both are the same to the degree of approximation considered, but $\cos \lambda\theta$ will enable the centroid to keep pace with the motion of the apse.

From (23) we see that both particles and their centroid always remain collinear with the origin, which is the invariable point of the system. Observe that this invariable point cannot be calculated by taking the centre of mass of the particles as though each had its mass increased separately by the effect of velocity. Such a process would give X proportional to $w^2\xi$ or $(r-2a) \cos \theta$. There is in fact no simple definition for the invariable point.

Expressed in polar coordinates the centroid describes the curve

$$R = -\frac{Ee}{2C^2} \frac{M-m}{(M+m)^2} \epsilon \cdot \frac{\epsilon + \cos \theta}{1 + \epsilon \cos \theta}, \quad \dots (24)$$

where $\epsilon = \sqrt{1 - s^2/q^2}$ is the eccentricity of the relative orbit of the particles. If $M > m$, R is negative at perigee, that is to say, the centroid is towards M . At apogee it is an equal distance towards m . If the time average of R be taken it is found to be

$$+ \frac{Ee}{2C^2} \frac{M-m}{(M+m)^2} \frac{1}{2} \epsilon^2, \quad \dots (25)$$

that is, on the average it is towards m . As the velocity of the lighter particle is the higher, so its mass is the more increased by the motion, and so (25) is directly contrary to

what would be expected at first sight. Observe that (24) shows that the centroid is at rest at the invariable point in the case of any circular orbit, as well as for the obvious cases $M=m$ and M infinite.

7. Finally we apply these results to Bohr's theory of spectra. To do so we use Sommerfeld's* quantum relations, so as to determine the integration constants p and W . These relations are

$$nh = \int p_{\theta} d\theta, \quad n'h = \int p_r dr,$$

where the integrations are carried round a complete period of the variable in each case. Then

$$nh = \int_0^{2\pi} p d\theta = 2\pi p \dots \dots \dots (26)$$

and

$$n'h = \int_0^{2\pi\lambda} \frac{\partial L'}{\partial r} \frac{dr}{d\theta} d\theta.$$

If the values be taken from (18) and (22), the last gives after some partial integration

$$n'h = p\lambda \int_0^{2\pi} -\frac{s \cos \phi + 4l \cos 2\phi}{q + s \cos \phi + l \cos 2\phi} + \alpha \frac{s^2 \sin^2 \phi}{q + s \cos \phi} d\phi.$$

The evaluation of the integral is rather long, but by taking advantage of the smallness of l and α it can be reduced to

$$n'h = 2\pi p\lambda \left\{ \frac{q}{(q^2 - s^2)^{1/2}} - 1 + 4l \frac{q}{s} - \frac{l}{s^2 (q^2 - s^2)^{3/2}} (4q^4 - 6q^2 s^2 + 3s^4) + \alpha [q - (q^2 - s^2)^{1/2}] \right\}.$$

Putting in the values from (22) we have

$$n'h = 2\pi p \left\{ \frac{g}{\sqrt{k}} - 1 + \frac{3}{2}\alpha g + \frac{1}{2}\beta - \alpha \sqrt{k} \right\}.$$

This is to be solved for W by using the values given in (21) and (26). The result is

$$W = \frac{2\pi^2 E^2 e^2}{h^2} \frac{Mm}{(M+m)} \frac{1}{(n+n')^2} \left\{ 1 + \frac{\rho^2}{(n+n')^2} \left[\frac{1}{4} + \frac{1}{4} \frac{Mm}{(M+m)^2} + \frac{n'}{n} \right] \right\}, \dots (27)$$

where $\rho = 2\pi Ee/Ch$. The spectrum lines are given by

$$\nu = \{ W(n_2, n_2') - W(n_1, n_1') \} / h.$$

* *Loc. cit.*

It was not of course to be anticipated that our work should give any effect perceptible experimentally for the distribution of lines in the hydrogen spectrum, but it is interesting to observe what extremely little difference the finite mass of the hydrogen nucleus does make. In the first place there is the factor $M/(M+m)$ in the large terms, corresponding to a slight alteration in Balmer's constant. This comes out of ordinary dynamics and was given by Sommerfeld. In addition, we have a minute shift of the whole position of the composite lines, represented by the term in $\frac{1}{4} \frac{Mm}{(M+m)^2}$. But the fine structure of each line, which is given by the term in n'/n , remains absolutely unaffected by the mass of the nucleus.

LII. *The Specific Heat of Carbon Dioxide and Steam.*

By W. T. DAVID, M.A.*

1. **T**HE specific heat of many gases, notably carbon dioxide and steam, increases very considerably with temperature. In this paper the suggestion is put forward that the specific heat of these gases depends to an appreciable extent upon volume and density as well as temperature.

2. Some of my experiments upon the emission of radiation in gaseous explosions indicate that the intrinsic radiance from thicknesses of gas containing the same number and kind of radiating molecules does not depend upon the temperature alone, even after correcting the radiation for absorption. This implies that the vibratory energy of the radiating molecules is not solely dependent upon the gas temperature. It depends upon the volume and the density of the gas as well †. I have suggested ‡ an explanation of this in terms of the kinetic theory of gases which it will be convenient to repeat here briefly. A radiating molecule as it describes its free-path loses energy owing to the emission of radiation and gains energy owing to the absorption of energy from the æther. Its vibratory energy will thus increase or decrease according as the absorption is greater or less than the emission. During collision with another molecule there will be a transference of energy between the vibratory and the rotational and translational energies, which, as Mr. Jeans

* Communicated by the Author.

† Phil. Trans. A. vol. cxxi. (1911) pp. 402 & 406.

‡ Phil. Mag. Feb. 1913, p. 267.

has shown, will be very rapid if the duration of collision is comparable with the periods of vibration of the molecule. In the case of carbon dioxide and steam at high temperatures (1000° C. and over*) the duration of collisions between molecules is probably short in comparison with the periods of their low frequency vibrations, and the vibratory energy of the molecules will therefore tend to take up during collisions a value such that the energy in each of the vibratory degrees of freedom† equals that in each of the rotational and translational degrees. During collisions therefore the vibratory energy of the molecules will tend to take up a value which is proportional to the absolute temperature; but, as we have seen, during the free-path there may be considerable departure from this value if the energy density in the æther is above or below a certain value and the time of description of free-path is not very short. It is clear therefore that the value of the vibratory energy of the molecules averaged over a time which is greater than that of the description of free-path may depart considerably from a value proportional to the absolute temperature of the gas. The extent of this departure will depend for any given gas at any given temperature upon the energy density in the æther (which, in view of the high transparency of a gas to its own radiation, is dependent in a very large measure upon its volume) and also upon the time of description of free-path (which, of course, depends upon the density of the gas).

3. The specific heat of a gas is dependent upon the translational, rotational, and vibratory energies of its constituent molecules. In a gas in thermal and chemical equilibrium the translational energy and the rotational energy are proportional to the absolute temperature of the gas; but, as we have seen, the vibratory energy may depend upon volume and density as well as temperature. The specific heat would therefore appear to depend upon volume and density as well as temperature. At any particular temperature the greater the volume of the gas the greater its specific heat, and the greater the density the less its specific heat.

4. It is clear from the theory suggested in § 2 that the vibratory energy of the molecules during the free-path will vary to a considerable extent only when the gas radiates

* See *Phil. Mag.* Jan. 1920, p. 93.

† Or, rather, those vibratory degrees of freedom which share in the heat motion of the gas. In the case of steam and carbon dioxide at temperatures of 1000° C. and over these degrees of freedom are those which correspond to radiation of 2.8μ and longer.

strongly. My experiments* show that carbon dioxide and steam emit radiation in appreciable quantity in the neighbourhood of 1000°C . and very strongly in the neighbourhood of 2000°C . The specific heat of these gases may therefore I think, be expected to vary slightly with density and volume at temperatures in the neighbourhood of 1000°C ., and at temperatures in the neighbourhood of 2000°C . the variation with these factors may be marked.

LIII. *On the Period and Decrement of an Oscillatory Electrical Circuit provided with a Short-circuited Secondary.*
By IOLO JONES, B.Sc., University Research Student, University College of North Wales, Bangor †.

THERE are several cases in which one of two coupled electrical circuits possesses inductance and capacity, and the other has its terminals connected through a resistance or is short-circuited. One example of this kind is afforded by an induction-coil immediately after contact is made at the interrupter. In this case the secondary coil, supposed to have no discharge between its terminals, has capacity, inductance, and resistance, and the primary is short-circuited. Another example is that of an induction-coil after "break," when the secondary terminals are connected by the arc which usually follows the passage of a spark. In these circumstances the primary circuit includes the condenser, and the secondary is short-circuited by the arc. Of the same nature is also the case in which a single circuit, including inductance and capacity, is provided with a tubular metallic core, the circular paths of the eddy currents induced in the core forming the short-circuited secondary.

In the present communication we shall consider the effect on the period and decrement of the oscillation of the system, of varying the resistance of the short-circuited coil. It will be assumed that a primary circuit, having self-inductance L_1 , capacity C_1 , and resistance R_1 , is coupled with a closed secondary coil having self-inductance L_2 and resistance R_2 , the mutual inductance of the two coils being M . It will also be assumed throughout that the capacity of the secondary is negligible; the resistance R_2 may be assumed to be varied by altering the thickness or the specific resistance of the secondary wire.

* Phil. Trans. A. vol. cxi. (1911) pp. 375-410.

† Communicated by Prof. E. Taylor Jones, D.Sc.

The fundamental equations for such a system are

$$L_1 \frac{di_1}{dt} + M \frac{di_2}{dt} + R_1 i_1 + V_1 = 0, \dots \dots \dots (1)$$

and
$$L_2 \frac{di_2}{dt} + M \frac{di_1}{dt} + R_2 i_2 = 0, \dots \dots \dots (2)$$

and the current flowing through the condenser is given by

$$i_1 = C_1 \frac{dV_1}{dt} \dots \dots \dots (3)$$

Substituting this value of i_1 in (1) and (2), these equations become

$$L_1 C_1 \frac{d^2 V_1}{dt^2} + M \frac{di_2}{dt} + R_1 C_1 \frac{dV_1}{dt} + V_1 = 0, \dots \dots (4)$$

$$L_2 \frac{di_2}{dt} + M C_1 \frac{d^2 V_1}{dt^2} + R_2 i_2 = 0. \dots \dots (5)$$

Assuming $V_1 = A e^{i\omega t}$, $i_2 = B e^{i\omega t}$, substituting in (4) and (5) and eliminating the ratio A/B , we arrive at the cubic

$$(L_1 L_2 - M^2) z^3 + (L_1 R_2 + L_2 R_1) z^2 + \left(\frac{L_2}{C_1} + R_1 R_2 \right) z + \frac{R_2}{C_1} = 0,$$

and on introducing the coupling $\frac{M^2}{L_1 L_2}$ represented by k^2 , this cubic becomes

$$z^3 + \frac{1}{1-k^2} \left(\frac{R_1}{L_1} + \frac{R_2}{L_2} \right) z^2 + \frac{1}{1-k^2} \left(\frac{1}{L_1 C_1} + \frac{R_1}{L_1} \cdot \frac{R_2}{L_2} \right) z + \frac{1}{1-k^2} \cdot \frac{R_2}{L_2} \cdot \frac{1}{L_1 C_1} = 0. \dots (6)$$

The solution for V_1 is known to be of the form

$$ae^{-k_1 t} \cos(2\pi n t - \theta) + be^{-\delta t},$$

where k_1 represents the decrement and n the frequency of the oscillations, so that the roots of the cubic (6) are given by

$$\left. \begin{aligned} z_1 &= -k_1 + 2\pi n i \\ z_2 &= -k_1 - 2\pi n i \\ z_3 &= -\delta. \end{aligned} \right\} \dots \dots \dots (7)$$

For the purpose of tracing the effect on k_1 and n of varying the ratio R_2/L_2 a number of numerical cases have been worked out. In these the following numerical values are assumed—

values which may be taken as typical of a fairly large induction-coil:—

$$\frac{R_1}{L_1} = 50,$$

$$L_1 C_1 = 7.66 \cdot 10^{-8} \text{ c.g.s.}$$

The coupling k^2 is varied from 0.5 to 0.95, and the ratio R_2/L_2 from 100 to 2000.

In each case the three roots of the cubic (6) were calculated by Cardan's formula, and hence the values of n , k_1 , and δ found by (7).

The results of these calculations are shown in Table I., the first column giving values of k^2 , the second those of R_2/L_2 , the third, fourth, and fifth columns the values of k_1 , n , and δ calculated as explained above.

TABLE I.

$R_1/L_1 = 50,$		$L_1 C_1 = 7.66 \cdot 10^{-8} \text{ c.g.s.}$		
$k^2.$	$R_2/L_2.$	$k_1.$	$n.$	$\delta.$
0.5	100	100.00	812.91	100.00
..	500	297.56	807.92	504.86
..	1000	530.00	792.98	1040.00
..	1500	729.43	768.78	1641.13
..	2000	873.81	736.84	2352.36
0.6	100	137.48	908.71	100.04
..	500	434.58	901.30	505.63
..	1000	788.10	878.76	1048.80
..	1500	1098.27	841.47	1678.47
..	2000	1322.85	789.01	2479.33
0.7	100	199.97	1049.10	100.06
..	500	663.23	1037.38	506.87
..	1000	1220.58	1001.62	1058.85
..	1500	1720.57	939.77	1725.51
..	2000	2088.21	848.03	2654.92
0.8	100	324.96	1284.38	100.07
..	500	1121.05	1263.26	507.91
..	1000	2090.73	1198.24	1068.54
..	1500	2985.30	1080.74	1779.38
..	2000	3649.52	884.52	2950.96
0.9	100	699.96	1814.39	100.08
..	500	2495.52	1758.10	508.94
..	1000	4709.98	1581.05	1080.02
..	1500	6825.84	1228.04	1848.32
..	2000		Imaginary	3919.21
0.95	100	1449.95	2560.32	100.09
..	500	5245.28	2407.02	509.45
..	1000	9957.12	1887.70	1085.75
..	1500		Imaginary	4057.57
..	2000	3679.45	225.17	33641.21

The results given in Table I. are also shown graphically in figs. 1-4.

Fig. 1.—Variation of k_1 with R_2/L_2 .

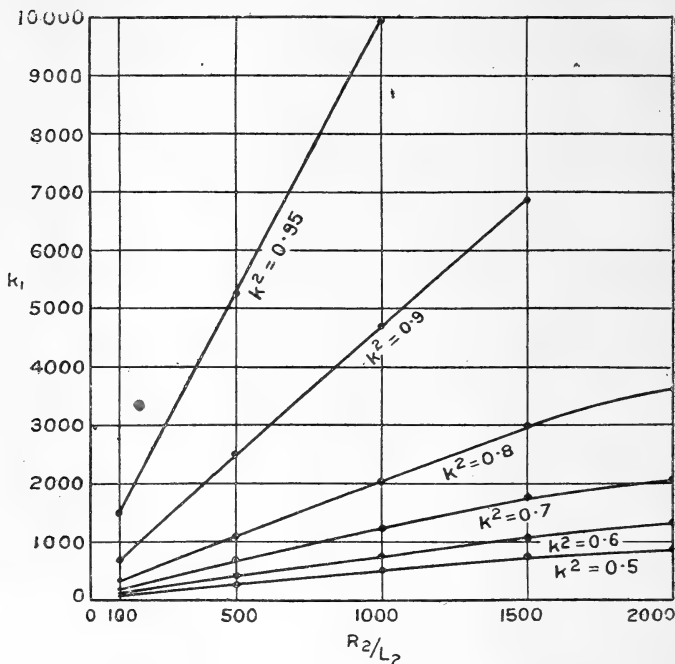

The general effect upon the damping of the oscillations caused by increasing R_2/L_2 with the coupling kept constant is shown in fig. 1. With a low coupling such as 0.5, the damping increases rather slowly with increase of R_2/L_2 , whilst for greater values of the coupling, the increase is more rapid and also more nearly uniform, the curve for the value $k^2=0.95$ being almost a straight line.

The effect of the variation of the coupling upon the decrement, R_2/L_2 being kept constant, is shown in fig. 2. The decrement increases with the coupling, more rapidly the closer the coupling.

Figs. 3 and 4 show the corresponding effects upon the frequency. At any constant value of the coupling the frequency diminishes as the ratio R_2/L_2 increases, the diminution being more rapid the greater the value of the coupling. With a constant value of R_2/L_2 , the effect of increasing the coupling is to increase the frequency, the rate of increase being greater for the smaller values of R_2/L_2 .

Fig. 2.—Variation of k_1 with k^2 .

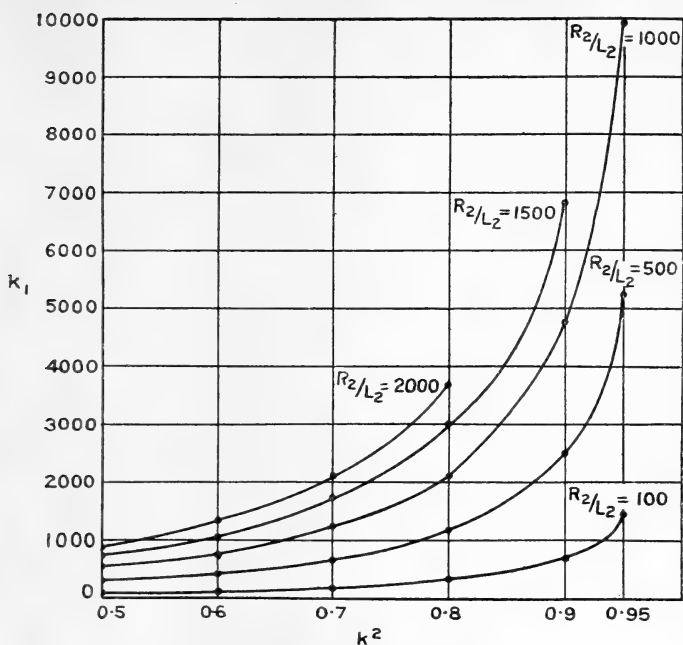

Fig. 3.—Variation of n with R_2/L_2 .

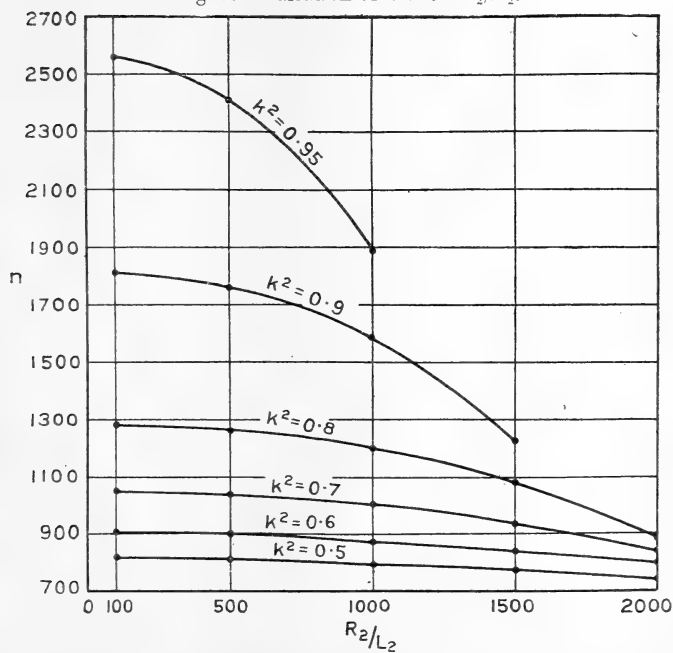
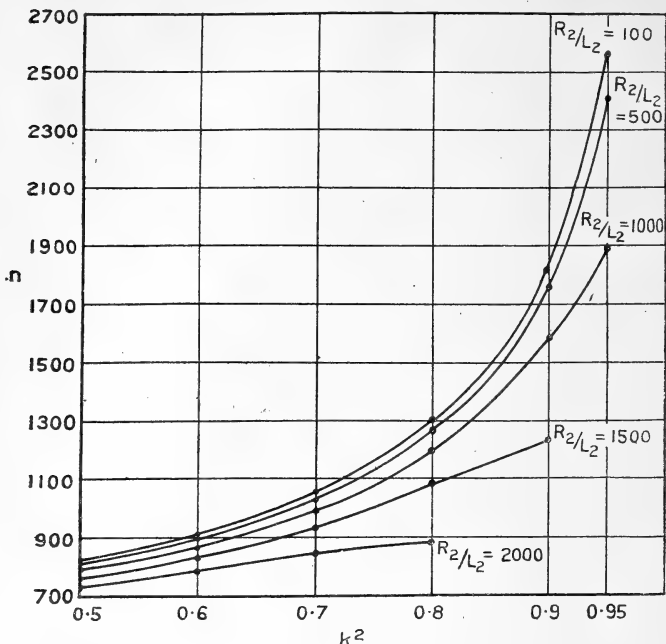

Fig. 4.—Variation of n with k^2 .



The Condition for Real Oscillations.

As shown in the Table, for certain values of k^2 and R_2/L_2 the corresponding values of the frequency become imaginary, which means that no oscillations are produced at these values of k^2 and R_2/L_2 . This occurs when the coupling is 0.9 and 0.95 and when the ratio R_2/L_2 is also large. It is clear however, that there must be a real oscillation when R_2 is infinite, in which case there is no induced secondary current, and consequently there must be, at the larger values of k^2 , a certain limited range of values of R_2/L_2 over which no real oscillations are produced. The extent of this range depends upon the coupling, and it can in fact be shown that there is a limiting value of k^2 , below which there are real oscillations for all values of R_2/L_2 , and above which there is a finite range of values of R_2/L_2 over which no real oscillations are produced.

Thus, considering the cubic in z given by (6) and writing it in the form

$$z^3 + 3bz^2 + 3cz + d = 0,$$

the condition that the roots of this cubic should be all real is

$$(d - 3bc + 2b^3)^2 + 4(c - b^2)^3 = 0$$

or $d^2 - 3b^2c^2 - 6bcd + 4b^3d + 4c^3 = 0,$

which, on transformation, reduces to the quartic in R_1/L_1

$$\begin{aligned} & \frac{R_1^4}{L_1^4} \left\{ -3K^2 \frac{R_2^2}{L_2^2} \right\} + \frac{R_1^3}{L_1^3} \left\{ \frac{R_2^3}{L_2^3} (4K - 6K^2) + 6K^2 \cdot \frac{1}{L_1 C_1} \cdot \frac{R_2}{L_2} \right\} \\ & + \frac{R_1^2}{L_1^2} \left\{ -3K^2 \frac{R_2^4}{L_2^4} + \frac{R_2^2}{L_2^2} (24K^2 - 6K) \frac{1}{L_1 C_1} - 3K^2 \frac{1}{(L_1 C_1)^2} \right\} \\ & + \frac{R_1}{L_1} \left\{ \frac{R_2^3}{L_2^3} (30K^2 - 18K) \frac{1}{L_1 C_1} + \frac{R_2}{L_2} (-6K^2 - 6K) \frac{1}{(L_1 C_1)^2} \right\} \\ & + 12K^2 \frac{1}{L_1 C_1} \cdot \frac{R_2^4}{L_2^4} + \frac{R_2^2}{L_2^2} (9 - 18K - 3K^2) \frac{1}{(L_1 C_1)^2} \\ & + 4K \frac{1}{(L_1 C_1)^3} = 0, \end{aligned}$$

where $3K = \frac{1}{1 - k^2}.$

We shall here confine our attention to the case $R_1 = 0$. The condition that all the roots of the cubic (6) should be real, or which is the same thing, the condition that n should be imaginary, is given by the quadratic in $(R_2/L_2)^2$

$$\frac{R_2^4}{L_2^4} (12K^2) + \frac{R_2^2}{L_2^2} (9 - 18K - 3K^2) \frac{1}{L_1 C_1} + 4K \frac{1}{(L_1 C_1)^2} = 0.$$

The condition that a range of values exists for R_2/L_2 over which there are no oscillations is that the roots of the above equation should be real,

i. e. $(9 - 18K - 3K^2)^2 - 192K^2 > 0,$

or $3K^4 - 28K^3 + 90K^2 - 108K + 27 > 0,$

or $(K - 3)^3 (K - 1/3) > 0,$

or $K > 3,$

or $k^2 > .889.$

Hence for all values of k^2 below .889, the oscillations are real whatever be the value of R_2/L_2 , whilst for values of k^2

above .889, there exists a range of values for R_2/L_2 over which no oscillations are produced.

Table II. shows this range of values for various values of k^2 between this limiting value .889 and unity, R_1 being kept at zero.

TABLE II.

$$R_1 = 0.$$

Coupling = k^2 .	Value of R_2/L_2 corresponding to Lower Lt. of Range.	Value of R_2/L_2 corresponding to Higher Lt. of Range.	Extent of Range.
0.889 = Limiting Value of k^2 .	2086.06	2086.06	0
0.90	2020.04	2043.70	22.96
0.93	1765.79	1956.08	190.29
0.95	1530.23	1907.67	377.44
0.97	1212.84	1864.37	651.53
0.99	715.33	1825.12	1109.79
0.999	228.10	1808.42	1580.32
1.00	0	1806.58	1806.58

Tables III.-VII. give the values of k , n , and δ for various values of the coupling, a little below and a little above the limiting value, R_2/L_2 being given various values ranging from 500 to 6000.

TABLE III.

$$k^2 = 0.7.$$

$$R_1/L_1 = 0, \quad L_1 C_1 = 7.66 \cdot 10^{-8} \text{ c.g.s.}$$

R_2/L_2 .	k_1 .	n .	δ .
0	0	1049.90	0
500	531.20	1038.67	506.84
1000	1137.52	1003.19	1058.30
1500	1634.32	944.04	1731.38
2000	2009.67	854.64	2647.33
2500	2043.47	743.08	4159.47
3000	1806.56	659.59	6386.87
3500	1504.03	620.95	8660.61
4000	1268.75	606.28	10795.83
5500	877.00	588.36	16579.33
6000	796.79	583.83	18406.43

TABLE IV.

$$k^2 = 0.85.$$

$$R_1/L_1 = 0, \quad L_1 C_1 = 7.66 \cdot 10^{-8} \text{ G.G.S.}$$

R_2/L_2 .	k_1 .	n .	δ .
0	0	1485.05	0
500	1412.46	1455.17	508.41
1000	2796.25	1361.15	1074.15
1500	4106.10	1182.34	1787.79
2000	5076.44	856.67	3179.26
2100	5113.92	751.55	3772.16
2200	4898.89	623.12	4867.87
2300	4185.53	533.40	6962.27
2500	3211.43	526.05	10243.80
3000	2268.19	545.45	15463.64
4000	1530.56	560.60	23604.56

TABLE V.

$$k^2 = 0.889.$$

$$R_1/L_1 = 0, \quad L_1 C_1 = 7.66 \cdot 10^{-8} \text{ C.G.S.}$$

R_2/L_2 .	k_1 .	n .	δ .
0	0	1725.16	0
500	1995.36	1672.59	509.28
1000	3960.80	1536.95	1078.40
1500	5832.85	1253.96	1834.30
2000	7241.11	597.95	3517.78
2100	5438.93	128.25	8022.15
2500	3031.10	469.03	16439.80
3000	2265.51	517.05	22468.99
4000	1570.21	547.55	32859.59

TABLE VI.

$$k^2 = 0.9.$$

$$R_1/L_1 = 0, \quad L_1 C_1 = 7.66 \cdot 10^{-8} \text{ C.G.S.}$$

R_2/L_2 .	k_1 .	n .	δ .
0	0.	1818.48	0
500	2244.72	1766.63	510.57
1000	4460.17	1599.63	1079.64
1500	6636.45	1269.05	1727.09
2000	8123.82	301.40	3752.36
2100	4648.09	60.52	11703.83
2500	3026.35	411.30	18947.30
3000	2260.31	509.74	25479.38
4000	1579.42	543.91	36841.15

TABLE VII.

$k^2=0.95.$

$R_1/L_1=0, \quad L_1C_1=7.66 \cdot 10^{-8} \text{ C.G.S.}$

$R_2/L_2.$	$k_1.$	$n.$	$\delta.$
0	0	2571.71	0
500	4547.28	2433.20	509.43
1000	9457.28	1956.50	1085.44
1500	14059.33	516.67	1881.34
2000	3780.90	214.35	32438.19
2500	2777.40	421.14	44457.21
3000	2223.06	481.66	55553.88
4000	1611.92	527.65	76776.27

Figs. 5-8 show the curves of variation of n with R_2/L_2 for different values of the coupling in the neighbourhood of the limiting value 0.889. Fig. 5 is the curve for $k^2=0.7$. At this coupling the frequency diminishes, but not uniformly so, as R_2/L_2 increases. At $k^2=0.85$ (fig. 6) the curve shows a

Fig. 5.

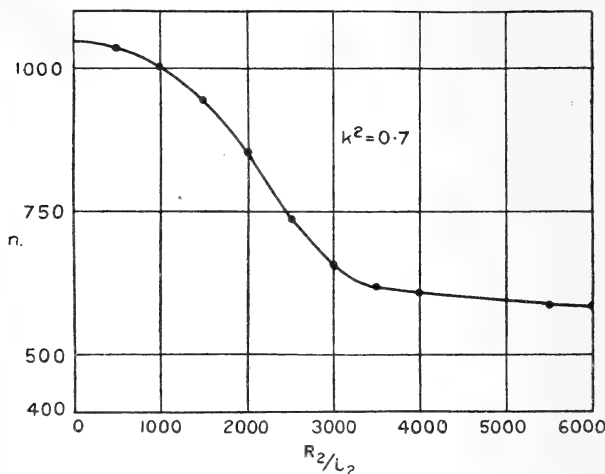

minimum frequency at R_2/L_2 nearly equal to 2400. The bend in the curve at this point develops into a double point in the curve for $k^2=0.889$, the limiting value, as shown in fig. 7. For values of k^2 above this limiting value, the curve breaks up into two distinct portions as shown in fig. 8, the curve for $k^2=0.95$.

Fig. 6.

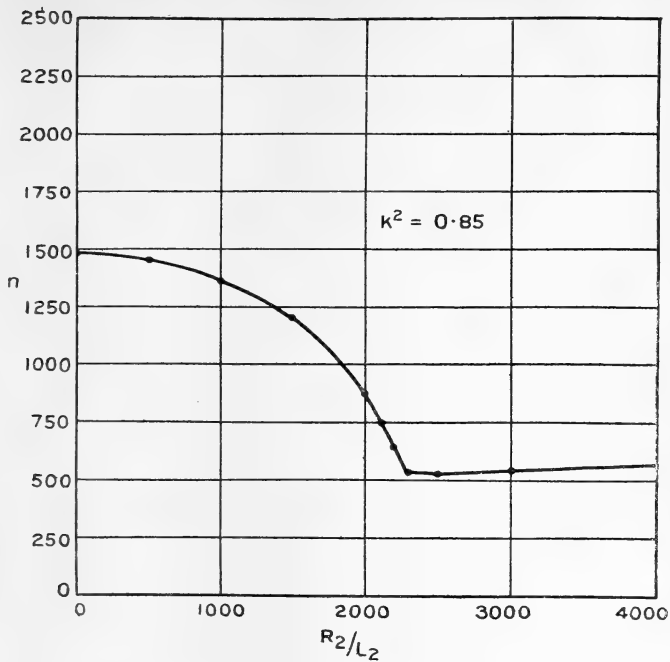

Fig. 7.

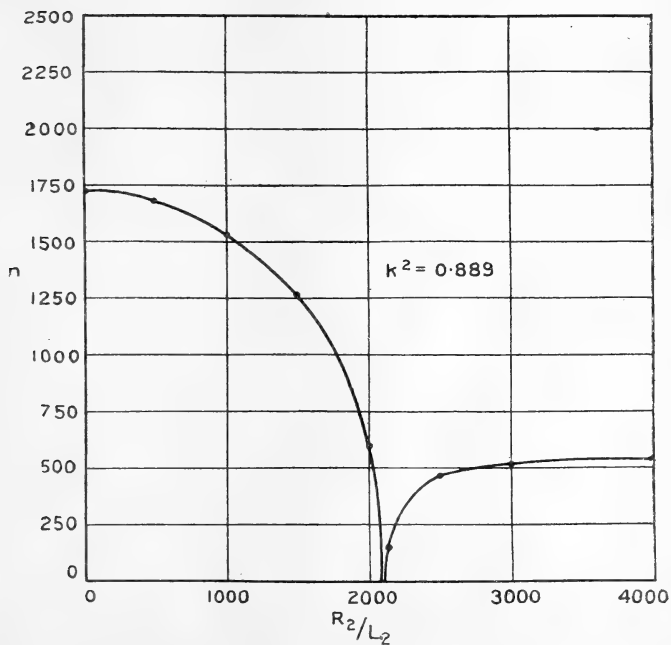
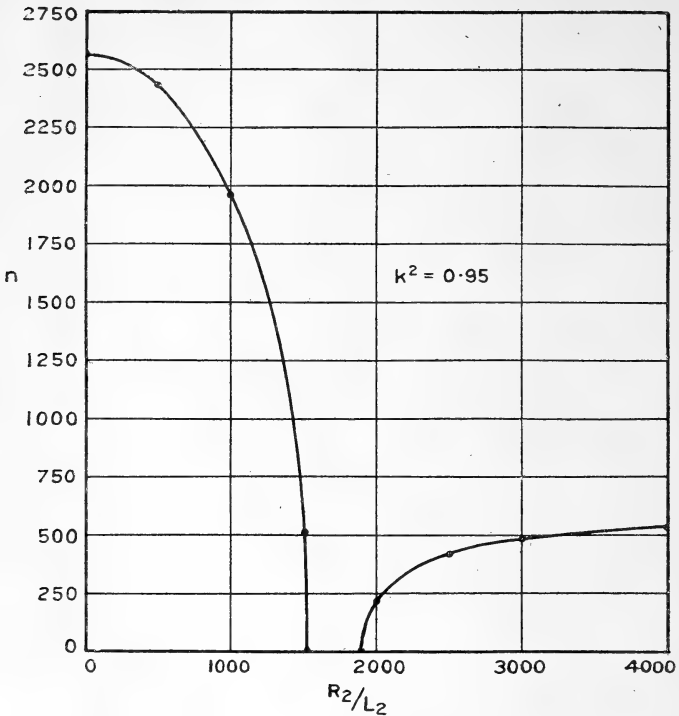

Fig. 8.



Comparison with the equation for a single circuit.

For a single circuit, the frequency of the oscillations is given by

$$n = \frac{1}{2\pi} \sqrt{\frac{1}{L_1 C_1} - k_1^2} \dots \dots \dots (8)$$

When R_2/L_2 is very large, the values of n given in the Tables should approximate to the values given by the formula. Table VIII. shows how this approximation becomes closer the higher the value of R_2/L_2 , k^2 in this case being 0.95.

It appears therefore that the simple expression (8), which is strictly applicable to a single oscillatory circuit possessing resistance, cannot generally be used when the damping arises from the resistance of a closed secondary coupled with the circuit. As already remarked, the above results are applicable only to the case in which the capacity of the secondary coil is negligible. In certain actual cases, when the secondary

TABLE VIII.

$$k^2 = 0.95.$$

$$R_1/L_1 = 0, \quad L_1 C_1 = 7.66 \cdot 10^{-8} \text{ C.G.S.}$$

R_2/L_2 .	ⁿ from Tables.	ⁿ from formula (8).
500	2433.20	Imaginary
1000	1956.50	Imaginary
1500	516.67	Imaginary
2000	214.35	Imaginary
2500	421.14	367.82
3000	481.66	453.32
4000	527.65	514.16
5000	546.68	538.32
6000	555.54	550.19

resistance is varied by means of a rheostat across the secondary terminals and the secondary capacity is not a negligible quantity, the system will possess two oscillations if the resistance of the rheostat is greater than a certain value.

The Physical Laboratory,
University College of North Wales,
Bangor.

LIV. *Light Absorption and Fluorescence.*—V. *The so-called Molecular Rotational Frequencies of Water.* By E. C. C. Baly, C.B.E., M.Sc., F.R.S., *Grant Professor of Inorganic Chemistry in the University of Liverpool* *.

IN a recent paper † the absorption system of sulphur dioxide was discussed, and it was shown that the whole of the absorption-bands shown by this gas can be expressed in terms of three fundamental frequencies: 2.4531×10^{11} , 8.19×10^{11} , and 1.296×10^{12} . It was also shown that the frequency 2.4531×10^{11} is characteristic of the atom of oxygen, and that the two frequencies 8.19×10^{11} and 1.296×10^{12} are characteristic of the atom of sulphur, since the infra-red absorption-bands of oxygen can be expressed in terms of the first and those of sulphur and hydrogen sulphide can be expressed in terms of the last two constants.

The combination of these three constants to give the frequencies characteristic of sulphur dioxide would seem

* Communicated by the Author.

† E. C. C. Baly and C. S. Garrett, *Phil. Mag.* vol. xxxi. p. 512 (1916).

to be of great importance, for it affords a very complete example of the least common multiple principle which forms the basis of the frequencies of absorption-bands, as has been pointed out in the earlier papers of this series. The least common multiple of the three frequencies of oxygen and sulphur given above is 2.89299×10^{12} , and this number multiplied by 10, 12, 14, 18, 26, and 33 gives the exact central frequencies of all the absorption-bands which have been observed for sulphur dioxide in the infra-red region between the wave-lengths 12μ and 3μ . Then, again, of these absorption-bands the one with the central frequency $2.89299 \times 14 \times 10^{12}$ has the greatest intensity, and this central frequency multiplied by 25 gives the exact central frequency of the less refrangible band in the ultra-violet, the central frequency of the more refrangible band not having been observed.

It is well known that the effect of cooling is to decrease the width of absorption-bands and that at very low temperatures only the central frequency remains, this persisting at the lowest temperature yet reached. It is evident therefore that the central frequency is the only one which is truly characteristic of the molecules, the subsidiary frequencies to which the breadth of the bands is due being connected in some way with the temperature of the molecules. These central frequencies are thus true molecular frequencies, and therefore it may be concluded that the fundamental molecular frequency of sulphur dioxide is the least common multiple of the frequencies characteristic of the sulphur and oxygen atoms it contains.

It was also shown that the subsidiary frequencies of sulphur dioxide to which the breadth of the absorption-bands is due are also derived from the three atomic frequencies of sulphur and oxygen. In the less refrangible absorption-band there are a number of sub-groups symmetrically distributed with respect to a central sub-group, and, further, each sub-group contains a central line of maximum absorptive power with a series of lines symmetrically arranged on either side of it. In the less refrangible absorption-band of sulphur dioxide the central lines of the sub-groups form a series with a constant frequency difference of 6.69696×10^{12} which is the least common multiple of two of the atomic frequencies, namely 8.19×10^{11} and 2.4531×10^{11} . Again, in the more refrangible band there exist sub-groups the central frequencies of which form a series with the constant frequency difference of

1.05972×10^{13} , which is the least common multiple of another pair of the atomic frequencies, namely 8.19×10^{11} and 1.296×10^{12} . Lastly, in each sub-group of the less refrangible band the component lines form a series with constant frequency difference of 8.19×10^{11} , which is one of those atomic frequencies compounded in the constant frequency difference of the series of the central lines of the sub-groups. The component lines of the sub-groups of the more refrangible band of sulphur dioxide have not yet been accurately measured.

It will thus be seen that, whilst the central frequencies of all the absorption-bands of sulphur dioxide are based on a molecular frequency which is the least common multiple of all three atomic frequencies, the sub-groups of the bands are due to the least common multiples of two out of the three atomic frequencies, and the component lines of the sub-groups are due to the atomic frequencies themselves. Each complete absorption-band therefore consists of a central or true molecular frequency, compounded with intra-molecular frequencies in the central lines of the sub-groups and with atomic frequencies in the component lines of the sub-groups.

Sulphur dioxide was the first substance in which these relations were completely worked out, since it was the first instance for which accurate measurements had been made both for the infra-red and for the individual lines composing one of the absorption-bands. Recently, however, Sleator* has published highly accurate measurements of water vapour at 6μ and 3μ , and it becomes possible to test whether a structure similar to that found in sulphur dioxide exists in the absorption-spectrum of water vapour. Further, if the atomic frequency 2.4531×10^{11} is truly characteristic of the oxygen atom, this value should form one of the atomic frequencies which is active in the case of the molecule of water.

It is well known from the works of Bjerrum and of Miss von Bahr that the two great absorption-bands of water at 6μ and 3μ consist of sub-groups and that the central frequencies of these sub-groups can be arranged in two series with constant frequency differences of 7.5×10^{11} and 1.7301×10^{12} respectively. By analogy with sulphur dioxide these differences will be intra-molecular frequencies, and therefore will be the least common multiples of two

* W. W. Sleator, *Astrophys. Journ.* vol. xlviii. p. 125 (1918).

out of the three atomic frequencies active in the water molecule. We therefore have to find a solution satisfying the following conditions if the analogy with sulphur dioxide is complete. Three atomic frequencies must exist of which one is 2.4531×10^{11} , the least common multiples of two pairs of these three must be 7.5×10^{11} and 1.7301×10^{12} , and the least common multiple of all three atomic frequencies must be a number of which exact multiples give the central frequencies of the great absorption-bands at 6μ and 3μ . The three atomic frequencies are at once found to be 1.0635×10^{11} , 2.1159×10^{11} , and 2.4531×10^{11} . The least common multiple of the first two is 7.5×10^{11} , the least common multiple of the last two is 1.7301×10^{12} , whilst the least common multiple of all three is 6.1326×10^{12} . The first two conditions are therefore satisfied. As regards the last condition, $6.1326 \times 8 \times 10^{12}$ is the frequency corresponding to the wave-length 6.115μ , the value observed by Coblentz being 6.1μ , whilst $6.1326 \times 16 \times 10^{12}$ corresponds to the wave-length 3.057μ , the values observed by Coblentz and by Paschen being 3.05μ and 3.07μ respectively. All three conditions therefore are exactly satisfied, and the fact that the atomic frequency of oxygen in the water and sulphur dioxide molecules is the same would seem to be of great importance.

It now becomes possible to put this solution to a very severe test by calculating from the above frequencies the wave-lengths of the component absorption-lines in the two great absorption-bands, and comparing them with Sleator's observed values. His measurements were made over the following regions: 1.35μ to 1.45μ , 1.81μ to 1.92μ , 2.52μ to 2.87μ , and 5.02μ to 6.83μ . The last two sets deal with portions of the two bands with centres at 3.057μ and 6.115μ respectively, and since the third set contains the greater number of individual measurements it will afford the best opportunity of testing whether the atomic frequencies given above are correct. As stated, there are present in the band two series of sub-groups, the central lines of each of which form a series with constant frequency difference, the two constant frequency differences being 7.5×10^{11} and 1.7301×10^{12} respectively. Now the central frequency of the band at 3μ is $6.1326 \times 16 \times 10^{12}$ or 9.81216×10^{13} , and obviously the frequencies of the complete set of the central lines of the sub-groups will be given by $9.81216 \times 10^{13} \pm m \times 1.7301 \times 10^{12}$ and $9.81216 \times 10^{13} \pm n \times 7.5 \times 10^{11}$, where m and n equal 1, 2,

3, etc. Sleator, however, only measured the lines in a portion of one side of the band, and all the central sub-group lines measured by him are given by $9.81216 \times 10^{13} + m \times 1.7301 \times 10^{12}$, where m equals 4, 5, ... 12, and $9.81216 \times 10^{13} + n \times 7.5 \times 10^{11}$, where n equals 9, 10, ... 27.

Then, again, there are the component lines in each sub-group, the frequencies of which are given by compounding the central frequency of each sub-group with the atomic frequencies. There are four such series of lines possible, two in each series of sub-groups, but the number of lines in any one of the sub-groups must be small, since the sub-groups are very narrow and closely situated in the band. The maximum number of lines in any one sub-group without overlapping is seven—namely, the central line and three on each side of it. In the second series of sub-groups, the central frequencies of which are given by $9.81216 \times 10^{13} + n \times 7.5 \times 10^{11}$, there should be two series of constant differences 1.0635×10^{11} and 2.1159×10^{11} , since 7.5×10^{11} is the least common multiple of these two atomic frequencies. But 2.1159 is very nearly twice 1.0635 and therefore it will be sufficient only to calculate the series with constant frequency difference 1.0635×10^{11} , and the formula for all the lines in the sub-groups will obviously be $9.81216 \times 10^{13} + n \times 7.5 \times 10^{11} \pm p \times 1.0635 \times 10^{11}$, where $n=9, 10, \dots, 27$, and $p=0, 1, 2, 3$.

Similarly, in the first series of sub-groups there should also be two series of lines with constant frequency difference, but it happens that the frequencies calculated are very nearly the same as those calculated for the second series of sub-groups. For the present purpose therefore they may be neglected. In Table I. are given the calculated values of all the lines in the second series of sub-groups and the central lines only of the first series, together with Sleator's measurements. In the first column are given the wave numbers ($1/\lambda$) for all the lines in the second series of sub-groups calculated from the above formula. The sixth column contains the wave numbers of the central lines of the first series of subgroups calculated from the frequency formula $9.81216 \times 10^{13} + m \times 1.7301$, where $m=4, 5, \dots, 12$. The second and fourth columns contain the corresponding wave-lengths, and in the fifth column are given the wave-lengths as observed by Sleator.

The agreement, on the whole, between the calculated and observed values is remarkably good, the maximum difference being 0.0022μ , whilst the general average is $\pm 0.00074 \mu$.

TABLE I.

SECOND SERIES.			FIRST SERIES.			
<i>m.</i>	$1/\lambda.$	λ calc.	λ obs.	λ calc.	$1/\lambda.$	<i>n.</i>
	348.86	2.8664	2.8658			
	349.22	2.8635				
9	349.57	2.8606	2.8590			
	349.93	2.8577				
	350.28	2.8548	2.8538	2.8560	350.14	4
	350.63	2.8520				
	351.00	2.8490	2.8485			
	351.64	2.8460				
	351.72	2.8432				
10	352.07	2.8403				
	352.43	2.8375	2.8373			
	352.78	2.8347	2.8336			
	353.13	2.8318				
	353.50	2.8288				
	353.86	2.8259	2.8267			
	354.22	2.8231				
11	354.57	2.8203	2.8197			
	354.93	2.8175				
	355.38	2.8147	2.8140			
	355.63	2.8199				
	356.00	2.8089	2.8103	2.8097	355.91	5
	356.36	2.8061	2.8077			
	356.72	2.8034	2.8029			
12	357.07	2.8006				
	357.43	2.7978	2.7972			
	357.78	2.7949	2.7947			
	358.13	2.7922	2.7926			
	358.50	2.7894				
	358.86	2.7866	2.7867			
	359.22	2.7838	2.7819			
13	359.57	2.7811	2.7803			
	359.93	2.7784	2.7777			
	360.28	2.7756	2.7765			
	360.63	2.7729	2.7712			
	361.00	2.7701	2.7700			
	361.36	2.7673	2.7668			
	361.72	2.7646	2.7655	2.7650	361.67	6
14	362.07	2.7619	2.7625			
	362.43	2.7592	2.7614			
	362.78	2.7565				
	363.13	2.7538	2.7545			
	363.50	2.7511	2.7511			
	363.86	2.7483	2.7479			
	364.22	2.7456				
15	364.57	2.7430	2.7445			
	364.93	2.7402	2.7407			
	365.28	2.7376	2.7386			
	365.63	2.7351	2.7340			
	365.80	2.7323	2.7314			
	366.36	2.7295	2.7294			
	366.72	2.7269	2.7278			
16	367.07	2.7243	2.7236			
	367.43	2.7216		2.7214	367.44	7
	367.78	2.7190	2.7198			
	368.14	2.7164	2.7168			
	368.50	3.7137				
	368.86	2.7111	2.7103			
	369.22	2.7084	2.7084			

SECOND SERIES.			FIRST SERIES.			
<i>m.</i>	1/ λ .	λ calc.	λ obs.	λ calc.	1/ λ .	<i>n.</i>
17	369.57	2.7058	2.7044			
	369.93	2.7033				
	370.28	2.7007	2.7006			
	370.63	2.6980	2.6974			
	371.00	2.6954				
	371.36	2.6927	2.6930			
18	371.72	3.6902				
	372.07	2.6876	2.6880			
	372.43	2.6852	2.6853			
	372.78	2.6826	2.6827			
	373.13	2.6800		2.6795	373.21	8
	373.50	2.6774	2.6783			
19	373.86	2.6748	2.6760			
	374.22	2.6722	2.6720			
	374.57	2.6697	2.6696			
	374.93	2.6672	2.6661			
	375.28	2.6647	2.6645			
	375.63	2.6620	2.6610			
20	376.00	2.6595	2.6590			
	376.36	2.6570				
	376.72	2.6545	2.6547			
	377.07	2.6520	2.6515			
	377.43	2.6495				
	377.78	2.6469				
21	378.13	2.6445	2.6448			
	378.50	2.6420	2.6411			
	378.86	2.6394	2.6385	2.6387	378.97	9
	379.22	2.6369				
	379.57	2.6346				
	379.93	2.6321	2.6325			
22	380.28	2.6297	2.6295			
	380.63	2.6272				
	381.00	2.6246	2.6256			
	381.36	2.6222				
	381.72	2.6198	2.6196			
	382.07	2.6173	2.6161			
23	382.43	2.6149				
	382.78	2.6125	2.6123			
	383.13	2.6101	2.6090			
	383.50	2.6075	2.6066			
	383.86	2.6051	2.6046			
	384.22	2.6027				
24	384.57	2.6003	2.6008	2.5991	384.74	10
	384.93	2.5979				
	385.20	2.5955				
	385.63	2.5931	2.5940			
	386.00	2.5907				
	386.36	2.5882	2.5880			
24	386.72	2.5859	2.5864			
	387.07	2.5835	2.5830			
	387.43	2.5811	2.5803			
	387.78	2.5788				
	388.13	2.5764	2.5760			
	388.50	2.5740				
24	388.86	2.5716	2.5727			
	389.22	2.5693	2.5688			

SECOND SERIES.			FIRST SERIES.			
<i>m.</i>	1/λ.	λ calc.	λ obs.	λ calc.	1/λ.	<i>n.</i>
25	389.57	2.5669				
	389.93	2.5646				
	390.28	2.5622	2.5636			
	390.63	2.5599	2.5608	2.5608	390.51	11
	391.00	2.5575				
	391.36	2.5552				
	391.72	2.5529				
26	392.07	2.5506	2.5520			
	392.43	2.5482				
	392.78	2.5460	2.5469			
	393.13	2.5437				
	393.50	2.5413	2.5425			
	393.86	2.5390				
	394.22	2.5367				
27	394.57	2.5344	2.5352			
	394.93	2.5321	2.5311			
	395.28	2.5299		2.5288	395.45	12
	395.63	2.5276				
	396.00	2.5253	2.5262			
	396.36	2.5230	2.5235			

The justification for the correctness of the calculation does not rest on this agreement so much as on the facts that Sleator has observed no more lines than are obtained by the use of the formula, and that the average difference between the observed wave numbers of his consecutive lines is just equal to that given by the formula. In view of the fact that the whole calculation is based only on the frequency differences 7.5×10^{10} and 1.7301×10^{11} , first obtained by Eucken, and the atomic frequency of oxygen obtained from the absorption-system of sulphur dioxide, it may be claimed that these results afford a somewhat striking confirmation of the theory of the system of absorption-lines shown by a substance between the limits 13μ and 0.2μ .

Sleator's measurements of the region between 5.02μ and 6.85μ do not reveal such a complexity of absorption-lines, and it is not worth while therefore to calculate the frequencies of all the lines which should appear in this region. It will be sufficient if the central frequencies of the two series of sub-groups are calculated and compared with the observed values. The central molecular frequency of the band as already stated is $6.1326 \times 8 \times 10^{12}$ or 4.90608×10^{13} , and therefore the frequencies of the central lines of the first series of sub-groups will be given by $4.90608 \times 10^{13} \pm m \times 1.7301 \times 10^{12}$, and those of the second series by $4.90608 \times 10^{13} \pm n \times 7.5 \times 10^{11}$, where m and n equal 0, 1, 2, 3, etc. In Table II. are given the wave numbers

and wave-lengths calculated from the different values of m and n , and in the fourth column are given Sleator's measurements. The agreement between observed and calculated values is again very good, especially when the fact is considered that in these measurements Sleator estimates his accuracy to be only one-tenth of that reached in the previous set set forth in Table I.

TABLE II.

SECOND SERIES.			FIRST SERIES.			
m .	$1/\lambda$.	λ calc.	λ obs.	λ calc.	$1/\lambda$.	n .
7	146.04	6.848	6.828	6.838	146.24	3
6	148.54	6.732	6.752			
5	151.04	6.621	6.634			
			6.573	6.579	152.00	2
4	153.54	6.513	6.520			
3	156.04	6.409	6.418			
			6.344	6.338	157.77	1
2	158.54	6.308	6.289			
1	161.04	6.210	6.216			
0	163.54	6.115	6.114	6.115	163.54	0
1	166.04	6.023	6.016			
2	168.54	5.934	5.938			
			5.895	5.907	169.30	1
3	171.04	5.847	5.864			
4	173.54	5.763	5.768			
			5.717	5.712	175.07	2
5	176.04	5.681	5.680			
6	178.54	5.601	5.617			
7	181.04	5.524	5.525	5.530	180.84	3
8	183.54	5.449	5.447			
9	186.04	5.375				
			5.352	5.359	186.60	4
10	188.54	5.304	5.309			
11	191.04	5.235	5.242			
12	193.54	5.167	5.172	5.171	193.37	5
13	196.04	5.102	5.111			
14	198.54	5.037	5.022	5.022	199.14	6

The results now obtained for the system of frequencies possessed by the molecules of sulphur dioxide and water establish very definitely the existence of simple relationships between the three sets of frequencies—molecular, intra-molecular, and atomic. Whilst the atomic frequencies are characteristic of the individual atoms and the molecular frequencies are characteristic of the molecule as a whole, the intra-molecular frequencies are characteristic of groups of atoms within the molecule. Remarkable confirmatory evidence of the reality of these intra-molecular frequencies and their origin in atomic groupings within the molecule is afforded by naphthalene. In one of the early papers of this series I dealt with certain constant frequency

differences between the sub-groups in the solution phosphorescence band of naphthalene. According to the theory of molecular rotational frequencies, this frequency difference of 1.4136×10^{13} should be the rotational frequency of naphthalene, and I therefore ventured to prophesy that this compound should exhibit a series of absorption-bands in the infra-red with frequencies given by $1.4136 \times m \times 10^{13}$, where $m=1, 2, 3$, etc. The infra-red absorption-spectra of naphthalene had not then been observed, but it has recently been examined by Stang* with the specific aim of putting my prophecy to the test of experiment, and he found no evidence of absorption-bands at those positions. The experience gained from sulphur dioxide, and now from water, shows that the frequency differences exhibited between the compound sub-groups of an absorption-band are not molecular but intra-molecular. It does not necessarily follow therefore that they will be exhibited as infra-red frequencies of naphthalene itself, but we are brought to the conclusion that they are characteristic of a definite atomic grouping present in naphthalene. Now the two principal atomic groupings in naphthalene are the benzene nucleus and the olefine linking. The intra-molecular origin of the frequency 1.4136×10^{13} would lead to the belief that this number is characteristic of—and, indeed, is the true molecular frequency of—either benzene or the olefines. In other words, benzene or the olefines should exhibit absorption-bands the central lines of which have the frequencies $1.4136 \times m \times 10^{13}$ or the wave-lengths 21.22μ , 10.61μ , 7.07μ , 5.31μ , 4.24μ , etc. Moreover, of these the intensity of absorption will be a maximum at $\lambda=21.22$ and fall with decreasing wave-length.

Now the absorption-spectrum of benzene shows important bands at 9.78μ , 6.75μ , 5.5μ , 3.25μ , and obviously therefore the above frequency is not associated with the atomic grouping of benzene. On the other hand, this frequency is absolutely characteristic of the olefines—a series of hydrocarbons which are almost identical in their absorptive power in the infra-red. Coblentz has investigated the region between 13μ and 2μ , and he found bands with centres at 10.5μ , 6.98μ , 5.30μ , and 4.32μ . These four bands are the only ones which the olefines show between 13μ and 4μ , and the amount of light absorbed at these maxima with the layer of olefine used was 98, 81, 47, and 14 per cent. respectively. Since Coblentz did not

* Stang, *Phys. Rev.* vol. ix. p. 542 (1917).

extend his observations beyond 13μ , he did not discover the great band which must exist with its centre at 21.22μ .

It is evident from the results given above that the observations are in direct conflict with the theory that molecular rotational frequencies play a fundamentally important rôle in absorption-spectra. According to this theory the molecules possess definite velocities of rotation, and Bjerrum pointed out that on the energy quantum theory the frequencies of rotation are given by $\frac{hn}{2\pi^2I}$, where h is the

Planck constant, 6.56×10^{-27} , I is the moment of inertia, and $n=1, 2, 3$, etc. These so-called rotational frequencies exhibit themselves as a series of absorption-bands in the long-wave infra-red and also as frequency differences within the short-wave infra-red bands. The width of the

rotational frequency bands is explained by saying that $\frac{hn}{2\pi^2I}$

only represents a most probable value exhibited by the majority of the molecules. Two criticisms at once may be made of this theory as it stands. In the first place, the inexactness of the rotational frequencies is thoroughly unsatisfactory, for the variations that have to be allowed in these frequencies are very great indeed. In the case of water the so-called rotational frequency series of bands have actually been observed, their frequencies being given by $1.7301 \times n \times 10^{12}$ and $7.5 \times n \times 10^{11}$. Now in each of these two series the consecutive bands overlap one another, and it follows therefore that the difference between the extreme values of any given molecular rotation must, at any rate, be equal to the difference between any two consecutive mean values. In the case, for example, of the

molecular rotational frequency $\frac{6h}{2\pi^2I}$, if x be the variation

the extreme values will be $\frac{6h}{2\pi^2I} \pm x$. Now observation

shows that $\frac{6h}{2\pi^2I} + x$ must be equal to or greater than

$\frac{7h}{2\pi^2I} - x$, a conclusion which deprives the theory of any

exact basis.

In the second place, it has been shown above and in previous papers that the sub-groups due to the so-called rotational frequencies have also a structure arising from

the existence of frequencies far slower than the rotational frequencies. It is difficult to conceive of any vibrations exhibited by a molecule, as a whole, which are far less rapid than its rotations.

Krüger* has proposed an alternative theory in that he substitutes precessional motions for the rotational velocities. He gives the following expression for the frequency of precession:

$$\nu = \frac{N}{2\pi A} \times \frac{1}{\cos \phi},$$

where N is the angular momentum of the electron spin, A is the moment of inertia of the atom nucleus perpendicular to the figure axis, and ϕ is the angle swept out by the figure axis as the result of the precession. By the absorption of one energy quantum the angle ϕ is increased and the value of $\frac{1}{\cos \phi}$ is doubled. Krüger himself saw the difficulty connected with the width of the absorption-bands due to the precessional motions. He was led to the conclusion that for a given precession the values of ϕ cannot be exact, but must lie between broad limits. But, as stated above, the cogent criticism must be made that in order to explain the observed phenomena it is necessary to postulate a difference between the extreme limits of a given mean value of $\frac{1}{\cos \phi}$, which is equal to or greater than the difference between two consecutive mean values of $\frac{1}{\cos \phi}$. Then, again, it is difficult to conceive of motions of a gyrostatic system far slower than its precessions.

But the most important fact to be considered in discussing these two theories is that the so-called molecular frequencies are due to small groups of atoms within the molecule, and that they are the least common multiples of the frequencies characteristic of those atoms. Further, the same atomic frequencies are shown by the same elementary atoms in different compounds—for example, oxygen in sulphur dioxide and water, and sulphur in hydrogen sulphide and sulphur dioxide. When two or more atoms enter into chemical combination, the resulting molecule is endowed with a

* F. Krüger, *Ann. der Physik*, vol. 1. p. 346, li. p. 450 (1916).

frequency which is the least common multiple of the atomic frequency of all its atoms. The molecule also exhibits as subsidiary frequencies both the least common multiples of the frequencies of groups of atoms forming a component part of itself and also the atomic frequencies themselves. I am of opinion that development along these lines affords much greater promise than either Bjerrum's theory of rotational velocities or Krüger's theory of precessional motions.

Before leaving the subject of the so-called rotational frequencies of water, attention may be drawn to a statement which is now becoming general in the literature—namely, that the central wave-length of the water band at 3.06μ is 3.26μ . It is nothing of the kind. The most accurate observations by Coblentz, Paschen, Rubens, and others show the centre to be at 3.06μ . The 3.26μ value is due to Miss von Bahr and is based not on measurements but on a misconception. In his early paper Bjerrum stated that the central line of an absorption-band should be the mean of the two central sub-groups. In this he was wrong, because it is now well known from the study of some hundred absorption-bands that there is one central sub-group and that the central line of this group is the central line of the whole band. In the case of water the central sub-group has its central line at 3.06μ and this is therefore the true centre of the whole band. Confusion will undoubtedly arise if this error is not corrected, and I therefore venture to draw attention to it. Indeed, the fact the molecular rotation theory leads to an erroneous value for the molecular or true central frequency of an absorption-band undoubtedly argues against the theory.

In conclusion, it may be said that the criticism I have given of the Bjerrum and Krüger theories must in no way be interpreted against the validity of the energy quantum theory or its application. It would, indeed, seem that the material now at hand forms an excellent opportunity for the application of the quantum theory, since a well-ordered discontinuity in the frequency shown by a molecule has been established. This, however, is reserved for another paper.

The University, Liverpool

LV. *On Turbulence in the Ocean.* By HAROLD JEFFREYS,
M.A., D.Sc., Fellow of St. John's College, Cambridge*.

I. *The Cause of Ocean Currents.*

THE main currents in the ocean were formerly attributed to the effects of expansion and contraction caused by differences in temperature between various parts of the water. In a heated area the surface would tend to be raised; and an outward current would therefore commence at the surface, compensated by an inward return current below. This explanation has, however, ceased to be regarded as adequate. In the first place, the differences in temperature are so small in comparison with their great horizontal extent as to be unable to produce the observed velocity of the surface water, on account of the low coefficient of expansion. In the second place, the heated areas of the sea would correspond approximately with those of the air above. Now heat tends to produce an area of high pressure at the top of a medium and one of low pressure at the bottom; thus, just below the surface of the water and on the same equipotential surface, we should have a high pressure in the heated area. In the air just above the pressure would be low. The horizontal forces on the air and the water would therefore always be in opposite directions, and hence the same would be true of the velocities, even when the rotation of the earth is taken into account. Actually this is not even approximately true; the ocean current and the trade wind agree roughly in direction.

Accordingly the general circulation of the ocean has come to be regarded as caused directly by the trade winds, the surface water being driven along by the wind above it. Here again, however, there is a difficulty with regard to the direction of the current. The ocean currents vary so slowly with time that they can be regarded as phenomena of steady motion, and on a rotating globe a steady velocity is always perpendicular to the controlling force, in this case the skin friction of the wind on the surface of the water. Thus apparently the current driven by a trade wind should be perpendicular to the wind. The problem is however complicated by the existence of turbulence in the ocean, and a treatment based on the theory of eddy motion is therefore desirable.

Let u and v be the components of the horizontal velocity

* Communicated by the Author.

of the water, ω the component of the earth's velocity of rotation about the vertical at the point considered, z the height above a standard equipotential surface, and k the coefficient of eddy viscosity. Then the equations of motion of the water are

$$k \frac{d^2 u}{dz^2} + 2\omega v = 0, \dots \dots \dots (1)$$

$$k \frac{d^2 v}{dz^2} - 2\omega u = 0. \dots \dots \dots (2)$$

If we put $w = u + iv$, these combine into the single equation

$$k \frac{d^2 w}{dz^2} - 2i\omega w = 0. \dots \dots \dots (3)$$

Suppose first that k is a constant. Then for a deep ocean the relevant solution of this equation is the one that remains finite when z tends to $-\infty$; and in the northern hemisphere this is

$$w = w_0 \exp \{z(1+i)\sqrt{(\omega/k)}\}, \dots \dots (4)$$

where w_0 is the value of w at the surface, and is to be determined from the condition that the rate at which momentum is communicated to a vertical column of water shall be equal to the skin friction at its upper surface. Now a column of unit cross-section gains in unit time by friction a momentum $\int k \frac{d^2 w}{dz^2} dz$, the integral being taken from the bottom of the ocean to the surface; and the skin friction on it is $\kappa \rho S^2$, where κ is a constant equal to about 0.002, ρ being the density of the air, and S the wind velocity, supposed along the axis of x . Then the surface condition is

$$w_0(1+i)(\omega k)^{\frac{1}{2}} = 0.002\rho S^2. \dots \dots (5)$$

As all the other factors are real, it follows that $w_0(1+i)$ is real. Hence in the northern hemisphere the surface current is always inclined at 45° to the wind, flowing towards the side where the pressure is greater. As the depth increases the velocity diminishes in magnitude and rotates clockwise. In the southern hemisphere the surface current is seen similarly to be inclined at 45° to the wind, flowing towards the side of greater pressure, but the current rotates counter-clockwise as the depth increases. The resultant momentum for all depths together is perpendicular to the wind, in accordance with the condition stated earlier.

When ω , w_0 , and S are known, equation (5) can be used

to calculate k , on the assumption that it is independent of the time and the depth. Now if Ω be the earth's angular velocity of rotation, ω is equal to $\Omega \sin \lambda$, where λ is the north latitude. Putting

$$\Omega = 7.3 \times 10^{-5} / 1 \text{ sec. and } \rho = 1.3 \times 10^{-3} \text{ g/cm.}^3,$$

we have

$$k = 5 \times 10^{-8} \frac{S^4}{w_0^2} \text{ cosec } \lambda.$$

S and w_0 must be measured in centimetres per second. In the following table such determinations have been made. The winds have been taken from Bartholomew's Meteorological Atlas, 1899, Plate 14, and the currents from Berghaus's Atlas der Hydrographie, 1891, Plate VI.

Ocean.	Latitude.	Longitude.	Wind velocity m/s.	Wind direction from	Current velocity (in n.m./h.).	Current direction from	Deviation in direction.	k cm. ² /sec.
N. Atlantic ...	40° N.	60° W.	8	S.W.	1½	W. by S.	33¾°	4
	40° N.	20° W.	10	S.W. by W.	½	N.W. by W.	67½°	120
	10° N.	40° W.	10	N.E.	½	E.	45°	460
S. Atlantic ...	36° S.	10° W.	8	N.W.	1	W.	45°	14
Indian	10° S.	80° E.	10	S.E.	¾	E.	45°	200
	40° S.	40° E.	>12	N.W. by W.	1½	W.	33¾°	30
N. Pacific ...	40° N.	160° E.	7	S.W.	1	W. by S.	33¾°	8
S. Pacific.....	10° S.	100° E.	8	S.E.	1	E.	45°	45
	40° S.	120° E.	10	N.W. by W.	½	W.	33¾°	120

The above localities were selected as giving some representation of each ocean and fairly determinate values of the mean annual wind and current. Many other localities were rejected on account of the large annual variation they showed. The prediction that the deviation in direction should be 45° is surprisingly well verified by these rough numerical data, for in no case does it differ from this by more than two points. The fundamental assumption that the vertical variation of k is small as far down as currents extend is therefore so far verified. The range of horizontal variation of k is however surprisingly great, the largest value found being over 100 times the smallest. Many factors may cooperate to cause this. The turbulence probably depends on the height of the waves produced, and this depends on the distance from land. Accordingly it was to be expected that the two smallest values of k would correspond to places near the American and Japanese coasts that the prevailing winds reach after traversing comparatively short distances

over the sea. Accidental error in the determination of the wind or the current must also be a very important factor; for in the calculation of k the wind velocity is raised to the fourth power and the current velocity to the second, so that any such error, even if itself small, becomes greatly magnified in importance. Local conditions, such as cyclonic disturbance and the temperature lapse-rate, affect the turbulence in the air and perhaps indirectly that in the water. Variations in the vertical distribution of salinity in the water near the surface may also affect the stability of the mass-distribution, and hence the turbulence; though in mid-ocean mixing is probably sufficiently thorough in the upper layers for such variations to be insignificant. It is on the whole, therefore, not surprising that considerable variations in the calculated turbulence occur.

The relation of the surface current to the wind has previously been considered by Waltrid Ekman*, who obtained the result here given that they are mutually inclined at 45° , and showed that in the main Atlantic current in latitude 10° N. the velocity is reversed at a depth corresponding to a turbulence coefficient of $29.5 \text{ cm.}^2/\text{sec.}$, about $\frac{1}{15}$ of the value here found for a similar place, though well within the limits of real variation. He did not apparently determine k for comparison from the observed velocities of the wind and current, as has been done here; the possibility of this comparison is largely due to G. I. Taylor's recent work on the skin friction of the wind on the surface of the earth.

It remains to be seen whether any other evidence indicates that such turbulence as is here calculated is possible. Direct observations of eddy currents in mid-ocean are lacking, but indirect evidence may be obtained from two other sources. Taylor showed that the value of k at any point is the average of the product of the vertical velocity in the eddies and the range through which they move vertically. Now near the surface the vertical range is presumably not very different from the wave-height h ; while the vertical eddy velocity will not be greater than the maximum vertical velocity of the water in a wave, and is probably very much less, since wave-motion in mid ocean is fairly regular in character, and the eddy motion corresponds only to the irregular part. Now D. W. Johnson mentions as a typical mid-Atlantic wave †, one with wave-length 400 feet, height 15 feet, wave-velocity 45 ft./sec.,

* *Arkiv för Matematik, &c., Akad. Stockholm*, Bd. 2, nr. 11 (1905).

† 'Shore Processes and Shore-line Development,' pp. 25 & 32 (1919).

and maximum velocity of the water $5\frac{1}{3}$ ft./sec. Then the product of the height and the velocity of the particles is 80 ft.²/sec. or 72000 cm.²/sec. This is of the order of 500 times the turbulence found, so that very little irregularity in the wave-motion is required to give the turbulence indicated by the current theory.

II. Vertical Transference of Heat.

Turbulence facilitates the downward transfer of heat in much the same way as it does that of momentum; this satisfies the equation

$$\frac{\partial V}{\partial t} = \frac{\partial}{\partial z} \left(k \frac{\partial V}{\partial z} \right),$$

where V is the temperature, t the time, and k the thermometric coefficient of eddy-conductivity, which is numerically equal to the eddy-viscosity. The only indication I have found of the character of this transfer is given by Murray and Hjort*, in the following table showing the temperature variations in the Atlantic outside the Sognefjord in 1903. Temperatures are expressed in degrees centigrade.

Depth (metres).	February.	May.	August.	November.
0	4.8	7.3	13.8	8.7
100	6.8	6.4	6.9	9.3
200	7.9	7.0	6.7	7.9
300	6.3	6.5	6.4	?

It will be noticed that at the surface the highest temperature for the year occurs in September; at 100 metres it is in November; at 200 metres in December; and at 300 metres in the spring. Thus the maximum occurs later and later as the depth increases, owing to the time needed for heat to penetrate downwards. It takes over six months to reach a depth of 300 metres, so that the phase of the annual variation is there reversed. To determine the vertical distribution of turbulence from the few data available is a matter of some difficulty, and I finally adopted the following method. The annual parts of the temperature variation depending on the sine and cosine of l , the increase in the sun's longitude since February 15th, were found for the four depths given. The coefficients of these were plotted against the depth on squared paper. If the annual part of the

* 'Depths of the Ocean,' p. 228 (1913).

temperature be $A \cos l + B \sin l$, the equation of heat transference can be written

$$k \left(\frac{dA}{dz} \cos l + \frac{dB}{dz} \sin l \right) = \int (-A \sin l + B \cos l) \frac{dl}{dt} dz,$$

where the lower limit of the integral is $z = -\infty$, since A and B both tend to zero there. dl/dt is the sun's mean motion, n say. Equating coefficients of $\cos l$ and $\sin l$ we have

$$k \frac{dA}{dz} = n \int B dz,$$

$$k \frac{dB}{dz} = -n \int A dz.$$

The two integrals and the differential coefficients were found roughly from the curves; the places where the integrals changed sign seemed fairly determinate, so that the maxima and minima of A and B could be placed moderately accurately. New curves were drawn to fit these, and from them the integrals and differential coefficients were redetermined; thus two estimates of k were obtained for each depth, and their agreement gave a test of the adequacy of the theory. The following table indicates the results of this rough interpolation.

Depth (metres).	A (in degrees C).	B	$\frac{dA}{dz}$	$\int B dz$	$\frac{k}{n}$	$\frac{dB}{dz}$	$\int A dz$	$\frac{k}{n}$
0	-4.5	-0.7	-15.0	-248	1.6	5.0	-74	1.5
50	-0.5	-1.7	-1.9	182	9.5	Small	Small	?
100	-0.05	-1.5	-0.6	-100	16.6	-0.5	65	13
150	+0.3	-1.2	-0.5	-32	6.4	-0.8	55	6.9
200	+0.6	-0.5	-0.4	-14	3.5	-2.5	35	1.4
250	+0.8	+0.2	Small	11	?	-0.3	Small	?
300	-0.05	+0.1?	Small	3?	?	0.3	-30?	?

In this table dA/dz and dB/dz are measured in degrees centigrade per hundred metres; $\int A dz$ and $\int B dz$ are in degrees multiplied by metres. Thus k/n is in square dekametres. Taking n to be $2 \times 10^{-7}/1$ second, and adopting for each depth the average of the two values of k obtained, we have the following values of k in $\text{cm.}^2/\text{sec.}$:—

Depth (in metres)...	0	50	100	150	200	250	300
k (in $\text{cm.}^2/\text{sec.}$)	0.31	1.90	3.00	1.33	0.49	?	?

The value of these results must not be exaggerated; but if the theory were seriously incorrect it is very unlikely that

it would have proved possible to interpolate at all in such a way as to secure even approximate agreement between the two estimates of k obtained for any depth, and perhaps as it is a considerably different distribution of turbulence would satisfy the data equally well. It will be noted that k is comparatively small near the surface, increases downwards to 100 metres, and then diminishes again. Now the results obtained for oceanic currents suggest that in mid-ocean, so far down as they extend, the turbulence is comparatively constant. Their vertical extent is of order $(k/\omega)^{\frac{1}{2}}$, according to the theory already developed, which in this case is about 1.2 metres. For the greater turbulence in mid-ocean the vertical extent of the currents is, of course, greater. The variation in turbulence found does not therefore invalidate the assumption of its constancy in the theory of ocean currents; but if the results just obtained are substantially correct they require an explanation. It is possible that near the Sognefjord the surface water is largely river water, and therefore lighter than that below. The greater density below would have a stabilising effect, tending to reduce turbulence in the surface layers. The Norwegian Oyster-basins, described by Murray and Hjort, afford an extreme example of such an effect; the low temperature above hinders the heat absorbed in the salt water below from being conveyed away, with the result that the deep water there is several degrees hotter than elsewhere. If turbulence can be largely attributed to wave-motion, the way it dies down at great depths is readily accounted for; for wave-motion diminishes as the depth increases, and at a depth equal to the wave-length it has practically ceased. This suggestion is confirmed by the fact that the depth where turbulence shows marked diminution is actually of the same order of magnitude as the length of Atlantic waves.

III. *Friction on the Ocean Bottom.*

The ocean currents driven by the trade winds are seen from the discussion in the first section of this paper to have a comparatively small vertical range. Even if the eddy-viscosity is as high as 1000 cm.²/sec. and the latitude as low as 10°, the depth through which the current is considerable, being of order $(k/\omega)^{\frac{1}{2}}$, is only about 4000 centimetres, an insignificant fraction of the depth of the ocean. If the theory that the main ocean currents are caused by the skin friction of the wind on the surface is correct, they must therefore be practically confined to the upper layers. The

atmosphere may, however, affect the movement of the ocean in another way. If the atmospheric pressure at a place A is greater than that at B, it will create a horizontal force tending to move the water from A towards B. When such a pressure-distribution is steady, the horizontal force steers the water so as to keep it moving along the isobars. Thus a geostrophic distribution of velocity is maintained in the water, and extends to the bottom. This velocity is not, however, great; for it is maintained by the same pressure differences as maintain the winds, and therefore, by the geostrophic condition

$$2\omega\rho v = \partial p / \partial v,$$

the velocities in the air and in the water are inversely proportional to the densities. Thus the current velocity is about $\frac{1}{800}$ of the wind velocity, and is of the order of 1 cm./sec. These currents are therefore small. Temperature differences, again, produce little effect at great depths; for the differences in density produced by them are small. Salinity currents are probably more important, though they are not usually noticeable except in restricted areas.

Another type of current that extends to the bottom of the ocean is the periodic tidal current, and the friction caused by it can be estimated. The two components of horizontal velocity u and v , except near the bottom, satisfy differential equations of the form

$$\frac{du}{dt} - 2\omega v = g \frac{\partial}{\partial x} (\bar{\zeta} - \zeta),$$

$$\frac{dv}{dt} + 2\omega u = g \frac{\partial}{\partial y} (\bar{\zeta} - \zeta),$$

where ζ is the elevation of the sea-level above its mean position and $\bar{\zeta}$ the height of the equilibrium tide. For motions periodic in 12 hours, u and v must therefore be of order $g\bar{\zeta}/\omega a$, where a is the radius of the earth. The height of the lunar equilibrium tide is $n^2 a^2 m / Mg$, where m is the mass of the moon, n its mean motion, and M the mass of the earth. Thus in all the amplitude of ζ is 37 cm., and

$$u = O(1 \text{ cm./sec.}).$$

The rate of dissipation of energy by skin friction is $0.002 u^3$ per sq. cm., or 0.002 erg per sq. cm. per sec. Over the whole ocean this gives a dissipation of the order of 10^{16} ergs per second.

This formula for the dissipation will, however, be correct only if the Osborne Reynolds criterion is satisfied. If h denote the vertical dimensions of the motion and ν the viscosity, this criterion is that uh/ν shall be greater than 1000. For semidiurnal motions in a viscous medium, $h^2 = \nu/\omega$, so that the criterion becomes $u/(\nu\omega)^{\frac{1}{2}}$ or 800. Thus it is not satisfied in general, though it probably holds in many places. Where it fails, the dissipation is due to ordinary viscosity and not to turbulence, and is readily estimated to be of order 1.2×10^{-3} erg per sq. cm. per second or 0.6×10^{16} ergs per second in all.

Thus friction in mid-ocean in any case is of the order of 10^{16} ergs per second; whereas G. I. Taylor finds that the actual dissipation in the Irish Sea is about 3×10^{17} ergs per second, and I find that the dissipation required to account for the moon's secular acceleration is about 1.4×10^{19} ergs per second. Thus the influence of tides in the open ocean on the moon is insignificant in comparison with that of the partly enclosed seas, and has no observable astronomical effect.

LVI. *Propagation of Light in a Gravitational Field.*
By A. O. RANKINE, D.Sc., and L. SILBERSTEIN, Ph.D.*

AS far as we know it has always been taken for granted, without any experimental support, that the velocity of light in a gravitational field, such as that of the earth, is independent of the orientation of the light oscillations. It seemed to us desirable to investigate, with as much precision as possible, whether, and how far, this is true; whether, for instance, the velocity of propagation c_h of horizontal oscillations is, or is not, appreciably different from c_v , the velocity of propagation of vertical oscillations. Such an enterprise was the more attractive as a slab of space, so to speak, of considerable thickness is always readily available thus promising the possibility of reaching a very high degree of exactness.

Before passing on to the description of our experiments and their simple theory, it may be well to notice that according to Einstein's generalized theory of relativity and gravitation, we should have, rigorously, $c_v = c_h$, more generally a velocity of propagation rigorously independent of the direction of the light vector relatively to the lines of force in any gravitational field. In fact, by Einstein's theory,

* Communicated by the Authors.

Maxwell's electromagnetic equations *in vacuo* retain, in any gravitational field, their familiar form

$$\left. \begin{aligned} \frac{\partial \mathfrak{M}}{c \cdot \partial t} + \text{curl } \mathbf{E} = 0, \text{ div } \mathfrak{M} = 0, \\ \frac{\partial \mathfrak{G}}{c \cdot \partial t} - \text{curl } \mathbf{M} = 0, \text{ div } \mathfrak{G} = \rho. \end{aligned} \right\} \dots \dots (M)$$

In absence of gravitation $\mathfrak{G} = \mathbf{E}$, and $\mathfrak{M} = \mathbf{M}$. In any gravitational field \mathfrak{G} and \mathfrak{M} are certain linear vector functions of \mathbf{E} and of \mathbf{M} respectively. The relations between the two pairs of vectors are given, in the usual notation, by the six relativistic equations

$$F^{\nu\kappa} = g^{\nu\alpha} g^{\kappa\beta} F_{\alpha\beta}, \dots \dots \dots (1)$$

due to Kottler, taken over by Einstein. Now, in the system in which the determinant

$$|g_{\nu\kappa}| \text{ is equal } -1, \text{ and } g_{14} = g_{24} = g_{34} = 0,$$

and which can be employed without loss to generality, we have, by (1), and writing $g^{\nu\kappa} = \gamma_{\nu\kappa}$,

$$\begin{aligned} M_1 = F^{23} = \mathfrak{M}_1(\gamma_{22}\gamma_{33} - \gamma_{23}^2) + \mathfrak{M}_2(\gamma_{23}\gamma_{31} - \gamma_{21}\gamma_{33}) \\ + \mathfrak{M}_3(\gamma_{21}\gamma_{32} - \gamma_{22}\gamma_{31}), \dots \dots (2) \end{aligned}$$

and two similar expressions for the second and the third component of \mathfrak{M} , and

$$\begin{aligned} -(\mathfrak{G}_1 = F^{14} = \gamma_{44}(\gamma_{11}F_{14} + \gamma_{12}F_{24} + \gamma_{13}F_{34}) \\ = \gamma_{44}(\gamma_{11}E_1 + \gamma_{12}E_2 + \gamma_{13}E_3), \dots \dots (3) \end{aligned}$$

and two similar equations by cyclic permutation. Thus, if $\tilde{\omega}$ be the three-dimensional linear vector operator

$$\begin{array}{ccc} \gamma_{11} & \gamma_{12} & \gamma_{13} \\ \gamma_{21} & \gamma_{22} & \gamma_{23} \\ \gamma_{31} & \gamma_{32} & \gamma_{33} \end{array}$$

or the matrix which belongs to γ_{44} as submatrix of the contravariant tensor $\gamma_{\nu\kappa}$, we have simply

$$\mathfrak{G} = -\gamma_{44} \cdot \tilde{\omega} \mathbf{E}.$$

Next, the coefficients of \mathfrak{M}_1 &c. in (2) are the minors of $\tilde{\omega}$ belonging to γ_{11} , γ_{12} , γ_{13} , respectively. Thus, inverting (2) and writing $|\tilde{\omega}|$ for the determinant of $\tilde{\omega}$, we have

$$\mathfrak{M} = \frac{1}{|\tilde{\omega}|} \tilde{\omega} \mathbf{M}.$$

But since $|g_{\nu\kappa}| = -1$, and, therefore, $\gamma_{44}|\tilde{\omega}| = -1$, we have at once

$$\mathfrak{M} = -\gamma_{44} \cdot \tilde{\omega} \mathbf{M}.$$

Thus, the relation of \mathfrak{M} to \mathbf{M} is exactly the same as that of \mathfrak{G} to \mathbf{E} , or, if we write, in the usual way, $\mathfrak{G} = K\mathbf{E}$, $\mathfrak{M} = \mu\mathbf{M}$, the permittivity operator K is identical with the permeability operator,

$$K = \mu = -\gamma_{44} \cdot \tilde{\omega}, \quad \dots \dots \dots (4)$$

both operators having the principal axes of $\tilde{\omega}$ and γ_{44} times its principal values. Now, such being the case, the velocity of propagation \mathfrak{v} can easily be proved to be independent of the orientation of the light vector. In fact if \mathbf{n} be the wave-normal, we have, from equations (M), with $\rho = 0$,

$$\frac{\mathfrak{v}}{c} K\mathbf{E} = \mathbf{V}\mathbf{M}\mathbf{n}; \quad \frac{\mathfrak{v}}{c} \mu\mathbf{M} = \mathbf{V}\mathbf{n}\mathbf{E}, \quad \dots \dots \dots (5)$$

and since the operator μ is identical with K ,

$$\frac{\mathfrak{v}^2}{c^2} K\mathbf{E} + \mathbf{V}\mathbf{n}(K^{-1}\mathbf{V}\mathbf{n}\mathbf{E}) = 0,$$

K^{-1} being the inverse operator of K . If K_1 , etc. be the principal values of K^* , and n_1 , etc. the components of \mathbf{n} along them (or the direction cosines of \mathbf{n}), the last equation becomes

$$\left[\frac{\mathfrak{v}^2}{c^2} K_1 K_2 K_3 - n_1^2 K_1 - n_2^2 K_2 - n_3^2 K_3 \right] \mathbf{E} + \mathbf{n}(\mathbf{n}K\mathbf{E}) = 0,$$

whatever the direction of the vector \mathbf{E} . But since by the first of (5), $\mathbf{n}K\mathbf{E} = 0$, we have ultimately

$$\frac{\mathfrak{v}^2}{c^2} = \frac{K_1 n_1^2 + K_2 n_2^2 + K_3 n_3^2}{K_1 K_2 K_3}. \quad \dots \dots \dots (6)$$

Thus, as was announced, the velocity of propagation of light is, in the most general gravitational field, a function of \mathbf{n} , but entirely independent of the orientation of the light vector.

Thus, also, we see that, according to Einstein's theory, no difference whatever is to be expected between our above said two velocities c_v and c_h . As to other theories, none of them contemplates any connexion at all between light propagation and gravity. But, apart from any theory, it

* Of these three values K_1, K_2, K_3 two are, as a matter of fact, equal in any gravitational field. But we can prove our statement even without profiting from this axial symmetry.

seemed of great interest to investigate this matter experimentally.

Consider two stations distant L apart on the same level. Let light rectilinearly polarized at 45° to the vertical be projected from the sending station. Then the phase difference ϵ of the vertical and horizontal components at the observing station will be given by

$$\epsilon T = L \left(\frac{1}{c_h} - \frac{1}{c_v} \right),$$

where T is the period of the light in question; or if $\lambda = cT$ be the normal wave-length and c_v and c_h differ but little from c ,

$$\epsilon = \frac{L}{\lambda} \cdot \frac{c_v - c_h}{c} \dots \dots \dots (7)$$

At the receiving station, therefore, we shall have elliptically polarized light, the principal axes of the ellipse making an angle of 45° with the vertical, and the coefficient of ellipticity, or ratio of minor to major axis being given by

$$\kappa = \frac{b}{a} = \sqrt{\frac{1 - \cos 2\pi\epsilon}{1 + \cos 2\pi\epsilon}} \dots \dots \dots (8)$$

If $2\pi\epsilon$ is a small angle this can be written

$$\kappa \doteq \left(\frac{2\pi^2\epsilon^2}{2} \right)^{\frac{1}{2}} = \pi\epsilon.$$

Thus by (7)

$$\frac{c_v - c_h}{c} = \frac{\kappa \cdot \lambda}{\pi L} \dots \dots \dots (9)$$

This formula enables us to evaluate the difference of the two velocities, if any, by measuring the ellipticity κ , the wave-length λ and the distance L being known. Owing to the ease with which L can be made very great in comparison with λ , an exceptionally high degree of precision can be attained even if it be difficult to measure small ellipticities κ .

Let us now pass to the description of the experiments. For measuring optical ellipticity it is natural to turn first to the Babinet compensator, although it did not appear likely that the produced effect, if any, would be sufficiently great to be detected by means of this instrument. Preliminary experiments quickly established this view. Light, originally plane polarized at 45° to the vertical by means of a nicol, was examined at various distances up to 40 metres with a Babinet compensator, and no shift of the bands was observable. It was estimated that a shift of, perhaps, one-twentieth of a band could be detected with certainty, and these observations

therefore proved that no ellipticity amounting to about $\kappa = 0.05$ comes into existence in a range of $L = 40$ metres.

In order to carry the measurements further, it was necessary to adopt a more sensitive method of detection, namely, one based upon observations of change of light intensity. Two modes of procedure were considered. Either one could polarize the light at 45° to the vertical, and examine the extent of extinction obtainable by an analysing nicol, first, close up to the polarizer, and then at increasing distances; or, fixing the polarizer and analyser at a definite considerable distance apart, one could observe any possible effect on the completeness of extinction caused by altering the orientation of original polarization from 0° * to 45° . For several reasons the second alternative seemed preferable. Of course, if it were possible to construct a rigid framework upon which polarizer and analyser could be separated to a great distance from one another without altering at all their relative orientation, the first alternative might be used. Such an installation would, however, be extremely costly, and, even so, it is unlikely that it would give results superior to those described in what follows.

The arrangement finally adopted was this. The source of light, a 100 candle-power pointolite lamp, was placed at the focus of a lens of 50 cm. focal length which collimated the light. The beam then proceeded through a large nicol which served as polarizer. The edges of this nicol were about two inches long, but only the central portion of it was used, a stop of $\frac{3}{4}$ inch aperture being interposed between the nicol and the collimating lens. A small nicol, placed in the beam of light 40 metres away, was used as analyser at the receiving station. Its scale was graduated in degrees, and read to $0^\circ.1$. For the sake of greater accuracy, the levelling screw on the stand of the instrument was calibrated so as to enable us to measure much smaller rotations—down to $0^\circ.003$.

It soon became evident that in order to get satisfactory extinction when the nicols were nominally crossed, lenses and all glass must be dispensed with between the two nicols. Even then there survived a small amount of light, which was primarily due to scattering by dust particles at the interface of the two halves of the polarizer. It was, however, very feeble. At 40 metres distance, viewed through the analyser, it needed careful watching, and often disappeared owing to the wandering of the eye. Experiments were now carried out after cessation of daylight in a long corridor in the

* It will be obvious that even if $c_v \neq c_h$ there will be no ellipticity produced provided the light vector at the source is either horizontal or vertical, and a maximum effect if it is inclined at 45° .

Imperial College, most suitable for the purpose, for various orientations of the polarizer, the eye being focussed, through the analyser, on the light emerging from the polarizer. From this procedure there accrued two advantages, as compared with the usual method of observing the illumination, by means of an eyepiece, in a plane near the analyser. It was possible to separate the actual light under observation from stray unpolarized light not coming from the polarizer. Also, this stray light seen, as it was, close to, but not overlapping the polarized beam, and suffering no change of brightness when the analyser was rotated, served as a standard of comparison for testing the completeness of extinction in relation to the orientation of the light vector. No difference of extinction at all could be detected. A small speck of stray unpolarized light (referred to above) was fortuitously in existence by the side of the polarizer. For all orientations of the polarizer it was possible to extinguish the polarized beam to such an extent that it was definitely less luminous than the stray speck mentioned.

Measurements were now made to establish an upper limit for the ellipticity of the light. It was found that in order to bring about a revival of light equal in luminosity to the standard speck, a rotation of the analyser through $0^{\circ} \cdot 012$, or about $0 \cdot 0002$ radian was necessary. Thus the ellipticity produced by gravitation was certainly distinctly smaller than 2×10^{-4} *.

Substituting this result, *i. e.* $\kappa < 2 \cdot 10^{-4}$ with $L = 4000$ cm., and $\lambda = 5 \times 10^{-5}$ cm., say, in equation (9), we have

$$\frac{c_v - c_h}{c} < 8 \cdot 10^{-13}.$$

In order to realize the meaning of this result, imagine a light wave travelling under similar conditions for one second. Then if one component lags at all behind the other the difference would be smaller than three hundredths of a millimetre in the three hundred thousand kilometres covered in that time. There are, perhaps, few pairs of physical magnitudes whose equality could be stated with equally high precision.

We take the opportunity of expressing our grateful thanks to Messrs. Adam Hilger for the loan of the Babinet compensator and the analysing nicol used in this investigation.

London,
21 January, 1920.

* It is perhaps worthy of notice that this corresponded to a relative change of brightness 4×10^{-3} , which could be detected by the eye

LVII. *Critical Velocities for Electrons in Helium.* By
FRANK HORTON, *Professor of Physics in the University of
London,* and ANN CATHERINE DAVIES, *Royal Holloway
College, Englefield Green* *.

IN a recent paper † the authors have shown that the first critical electron velocity for the normal helium atom is 20·4 volts, and that an electron with this velocity is able to produce radiation from the atom on collision with it. It was also shown that when the velocity of the impacting electron is increased to 25·6 volts, it is able to produce ionization by collision. This value of the minimum ionization velocity is lower than that predicted for the normal helium atom by Bohr's theory, according to which the electron velocity necessary for the removal of one electron from a helium atom is 2·13 times the electron velocity required to ionize an atom of hydrogen, while the electron velocity necessary to remove both electrons from a helium atom at a single collision is 6·13 times the hydrogen ionization velocity. Taking the values $e=4\cdot774 \times 10^{-10}$ E.S.U., $e/m=1\cdot767 \times 10^7$ E.M.U., and $h=6\cdot547 \times 10^{-27}$ gm. cm.²/sec., Bohr's theory gives 13·54 volts as the hydrogen ionization velocity. The two critical ionization velocities for helium, calculated from Bohr's theory, are therefore 28·84 volts and 83·00 volts respectively, the difference between these two velocities, viz. 54·16 volts, being the electron velocity which, according to the same theory, would be required for the removal of the second electron from a helium atom which had already been ionized.

After the conclusion of the experiments described in our earlier paper, we investigated the effects of collisions between helium atoms and electrons having considerably greater velocities, with a view to obtaining some further evidence of the validity of Bohr's assumptions, by determining accurately the velocity at which both electrons are removed from the normal helium atom at a single collision. This investigation presented considerable difficulty on account of the fact that, at the higher critical velocities, increases of radiation or of ionization have to be detected in the presence of the effects which occur at lower velocities. Our experiments showed that to obtain a degree of accuracy at all comparable with that attained in the earlier research, it would be necessary to use an electron stream in which all the electrons have the same velocity, so that the breaks in the current curves,

* Communicated by the Authors.

† Proc. Roy. Soc. A. vol. xcv. p. 408 (1919).

which indicate critical points, may be well marked. We hope to make further experiments using an apparatus in which the electrons in the primary stream are sorted out by means of a magnetic field, so that all those which enter the ionization chamber have the same velocity. The results contained in the present paper, which can only be considered as approximate, are given for comparison with the recently published work of Franck and Knipping*. These authors have obtained values in agreement with those which we found for the minimum electron velocities for the production of radiation and of ionization in helium, and, in addition, have produced evidence that a third type of collision, resulting in an increase of ionization, occurs when the velocity of the impacting electron is raised to 79.5 volts. In determining this latter point the difficulties we have mentioned, of obtaining really marked bends in the current curves with high electron velocities, were also experienced.

The arrangements used in the present experiments have been described in detail in earlier papers, but the method can be understood by reference to the diagrammatic representation in fig. 1. Electrons from the glowing filament F

Fig. 1.

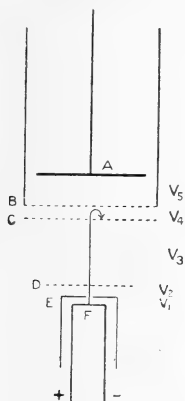

were accelerated towards the surrounding electrode E by a difference of potential, V_1 , which was constant during any particular series of observations. Those electrons which passed through the small hole in the centre of the top of E, were further accelerated by the potential difference V_2 , which was varied during the experiments. The potential

* J. Franck and P. Knipping, *Phys. Zeits.* xx. p. 481 (1919).

difference V_4 , between the gauzes B and C, was in the reverse direction to V_1 and V_2 , and was sufficiently great to prevent any of the electrons from reaching B. The usual path of the electron stream is thus indicated by the arrow in the diagram. A represents the collecting electrode which was connected to a sensitive electrometer for measuring the currents due to ionization or radiation. Its distance from the gauze B could be varied over a range of several centimetres. In most of the experiments the apparatus employed was that which we had used in our previous investigation with helium, but the gauze C had been added, the distance between C and D being about 1 cm. The later experiments were made with a slightly modified form of apparatus in which the distance between C and D was about 3 cm., and this apparatus was afterwards used for experiments with argon; a complete description of it is given in the Proceedings of the Royal Society, A. vol. xcvii. p. 1. The helium used was carefully purified before being stored, and during the observations was slowly circulating through the experimental tube, entering through a U-tube containing carbon and immersed in liquid air. The pressure of the gas during the experiments was varied according to the particular point which was under investigation.

In considering the points at which breaks might be expected in the current-potential difference curves for high values of the accelerating potential difference, we started from the facts already established, that radiation is produced from helium by impacts of electrons with 20.4 volts velocity, and ionization by impacts of electrons with 25.6 volts velocity. Under suitable conditions of pressure it should be possible to obtain curves giving indications of the production of radiation and of ionization by the second, third, etc. inelastic collisions of electrons with helium atoms. The particular points on the curve at which indications are to be expected will depend upon whether the distance over which the accelerating potential difference is applied is large or small compared with the mean free path of an electron in the gas. For instance, in order that a radiation curve should show increases of radiation at multiples of the resonance velocity (20.4 volts), the pressure must be so high that most of the electrons in the stream from the filament make several collisions in traversing the distance over which the accelerating potential difference is applied, so that for the range of velocities used the potential fall along a free path is not likely to exceed the resonance voltage. Under these conditions, very little, if any, ionization will take

place at 25.6 volts, because so few of the electrons can acquire the necessary energy*. It would thus seem that the conditions necessary for the increases of radiation to occur to any large extent at multiples of 20.4 volts, and the conditions necessary for the indication of ionization at 25.6 volts, are mutually exclusive.

If the pressure is so adjusted that the distance over which the accelerating voltage is applied is about the same as, or is smaller than, the mean free path of an electron in the gas, the points at which bends, other than those at 20.4 volts and 25.6 volts, occur in the current-potential difference curves will depend upon the length of path traversed by the electrons before their energy is reduced by the retarding field to a value below that at which they can make inelastic collisions. If this distance is large compared with the mean free path, so that the electrons make several collisions with gas atoms, the current-potential difference curve may be expected to indicate an increased production of radiation at $(25.6 + 20.4 =) 46.0$ volts, and an increased production of ionization at $(25.6 + 25.6 =) 51.2$ volts. Increases of radiation and ionization should occur again at 71.6 volts and at 76.8 volts, respectively, and so on. If, however, this distance is about equal to the mean free path or is less than this, the current-potential difference curves would not be expected to show breaks at the velocities just mentioned, but would be expected to do so when collisions between electrons and gas atoms occurred which resulted in the transference, at a single impact, of a larger amount of energy than that corresponding to 25.6 volts, such, for instance, as would result in both electrons being removed simultaneously from the helium atom, at which point the curve should indicate an increase of ionization. Such collisions would not be prevented from occurring, even when the path traversed by the electrons after acquiring the energy corresponding to the applied accelerating potential difference, and before they have had their velocity reduced below 20.4 volts, is several times the mean free path (as in the case when bends at 46.0, 51.2, 71.6, and 76.8 volts would be expected); but it is probable that under these conditions, the effect would be to produce a flattening of the curve, instead of an increase of slope, since

* Although, under the conditions mentioned, this statement is probably true of the greater proportion of the electrons in the stream, certain experiments which are referred to in Proc. Roy. Soc. A. vol. xevii. p. 1, seem to show that even when the distance traversed by an electron with a velocity above the critical value is several times the mean free path, some electrons can traverse this distance without suffering an inelastic collision.

the double ionization of the helium atom at a single collision which, according to Bohr's theory, should occur at 83 volts, would result in the production of less positive electricity than the expenditure of a smaller amount of electricity in removing single electrons from three helium atoms, with the consequent loss of 25.6 volts velocity at each of the three successive collisions.

In most of the experiments described in this paper, the gauzes D and C were at the same potential, so that the electrons, after being accelerated by the fields V_1 and V_2 , traversed the distance between D and C without suffering any reduction of velocity except that resulting from their collisions with helium atoms. The electron stream was prevented from spreading laterally in this space by means of a magnetic field, parallel to the axis of the tube, applied by passing a current of about 2 amperes through a coil of many turns of wire wrapped round the experimental tube. Since there is no difference of potential between the gauzes D and C, the detection of ionization depends upon the diffusion of the positive ions out of this space. Those which pass through the gauze C will be accelerated by the field V_4 (which retards the electron stream) and driven towards the gauze B. Some of these will pass through B and reach the collecting electrode A, provided that the field between B and A does not oppose them, or is insufficient to turn them back. Experiments showed that this method gave satisfactory results, and that, with the gas-pressure suitably adjusted, ionization could always be detected when the accelerating potential difference was increased beyond the ionization value.

Some of the curves obtained, which illustrate the differences in the effects occurring at different gas-pressures, are given in figs. 2, 3, and 4. In these curves (and in the others given in this paper) the electron velocities, expressed in equivalent volts, are those of the swiftest electrons present in the stream from the filament. The method of obtaining these velocities for given values of the applied accelerating potential difference is explained in our earlier paper*. The curve in fig. 2 was taken under such conditions that any positive ions produced would be prevented from reaching the collecting electrode, so that the current due to radiation was examined alone. The gas pressure during this experiment was about 1.5 mm., which should cause the electrons to make several collisions with helium atoms while traversing the distance over which the accelerating potential difference was applied. It will be observed that the curve indicates an

* *Loc. cit.*

increased production of radiation at the second and third multiples of the resonance potential difference.

Fig. 2.

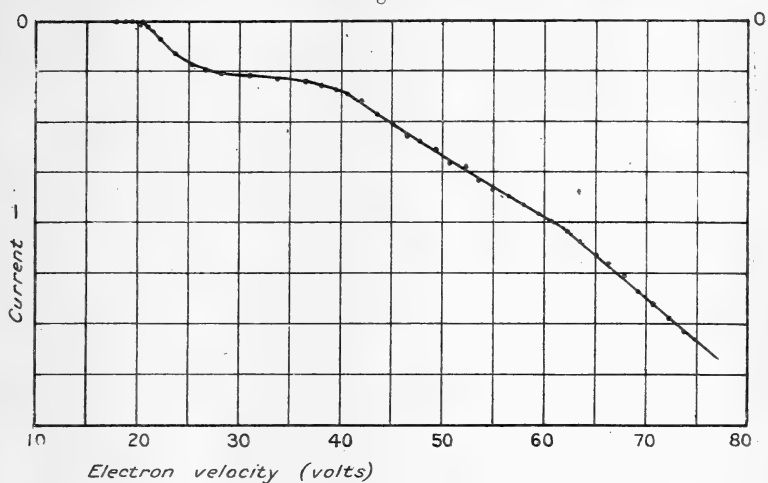

Fig. 3.

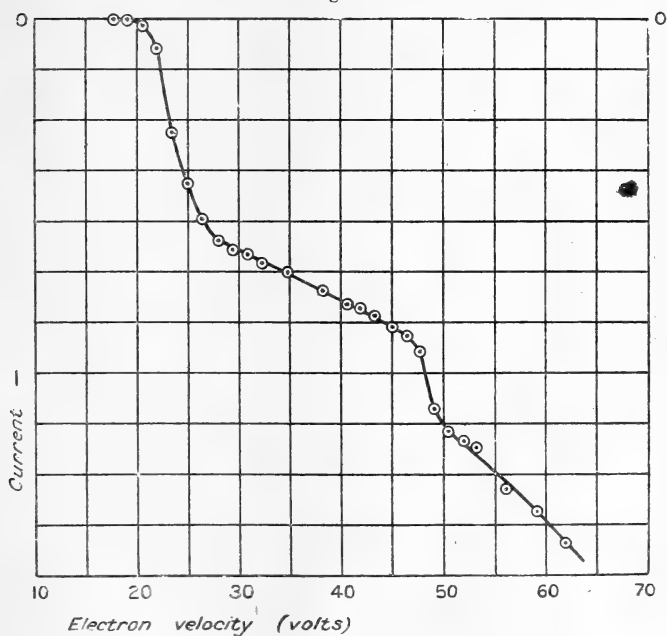
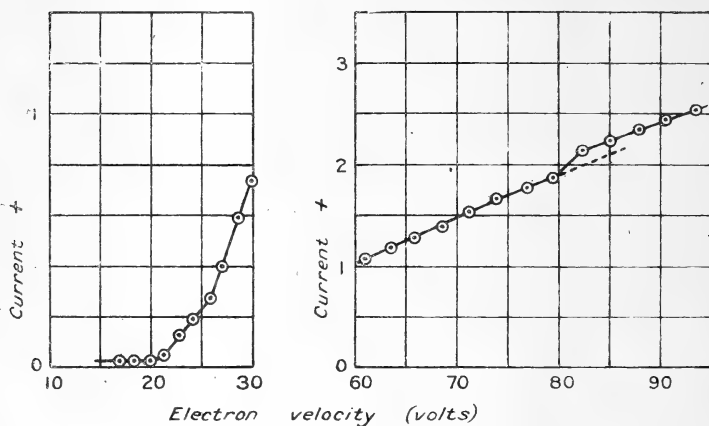

Fig. 3 also represents a series of observations of the variation with the velocity of the electrons, of the current

due to radiation alone. These observations were taken at a pressure of 0.49 mm., so that most of the electrons would not make more than one collision while traversing the distance over which the accelerating potential difference was applied. This curve indicates an increased production of radiation, not at the second multiple of the resonance velocity but at $(25.6 + 20.4 =) 46.0$ volts.

In the curve of fig. 4 the pressure is still lower, being only 0.17 mm., and at this pressure it is probable that a

Fig. 4



considerable proportion of the electrons pass through the space between the gauzes D and C without making more than one collision with a helium atom, and it is certain that very few, if any, will be able to make three collisions while traversing this distance. For this series of observations the fields were so arranged that radiation and ionization would both cause the electrometer to indicate a positive current. The curve shows a bend at 20.5 volts, another at 25.6 volts, and another one in the neighbourhood of 80 volts. The critical velocity indicated at 80 volts is presumably that at which both electrons are removed from the atom at a single collision. Other series of observations agreed in fixing the critical velocity at which this occurs at about 80 volts, but the difficulty of obtaining the point accurately has already been mentioned. This value should be the sum of the velocities required to remove the two electrons separately from the helium atom. We have shown experimentally that an electron velocity of 25.6 volts is required to remove the first electron, so that the difference between the two experimentally determined values, *i. e.* about 54 volts, is the velocity required to remove the second electron. This

value agrees with the value deduced from Bohr's theory. In the course of our investigation we obtained direct experimental evidence of the existence of a critical velocity at about this point. It has been mentioned that in most of our experiments there was no difference of potential between the gauzes D and C, in the space between which most of the ionization occurred. In view of this fact, when the ionization velocity has been exceeded, positive ions will be distributed throughout the path of the primary electrons, and it is possible that at a suitable pressure and with a sufficiently intense electron stream, collisions take place between ionized helium atoms and electrons with considerable velocities. If a sufficient number of such collisions occurred, the current-potential difference curve would be expected to show a rise when further ionization resulted from these encounters. An example of a curve in

Fig. 5.

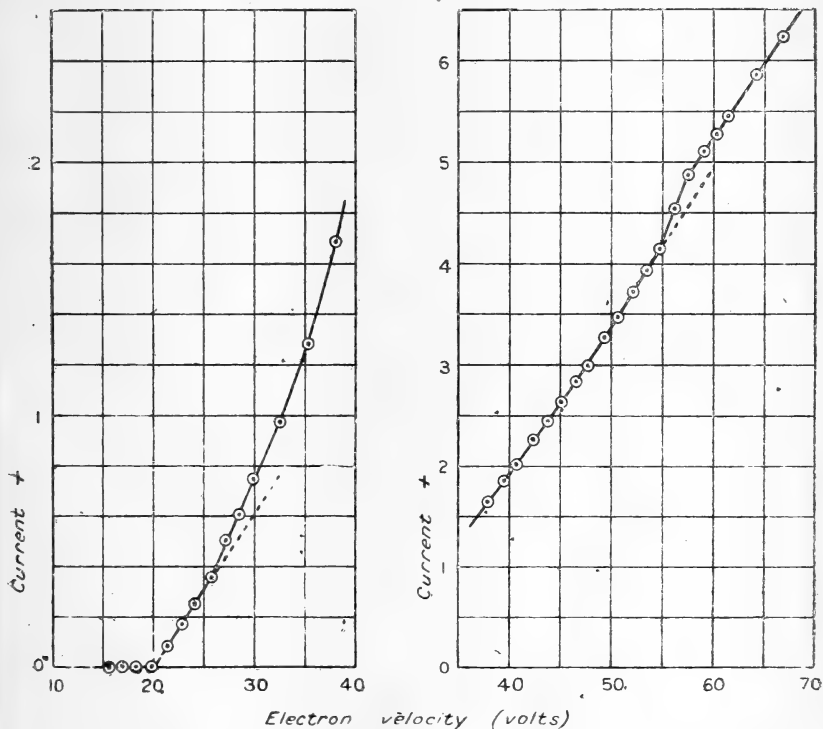

which an increase of current was obtained, which could not be attributed to the production of radiation or ionization by the successive collisions of an electron with different helium atoms, is given in fig. 5. This curve was obtained

at a pressure of 0.35 mm., and shows an increase of positive current at about 55 volts. It is therefore possible that this bend does indicate the production of ionization as a result of encounters between ionized helium atoms and electrons having this velocity, and that it thus affords direct experimental evidence of the correctness of Bohr's assumptions as applied to the helium atom which has lost one electron.

If collisions occur between *ionized* atoms and electrons, it follows that the number of collisions between electrons and *normal* helium atoms will be reduced by the recombination which probably results when the velocity of the impacting electron is lower than some critical value. On this account, with the intense electron stream which must be used in order that the electron collisions with ionized atoms may be sufficiently numerous for the removal of the second electrons from these ionized atoms to cause a rise in the current curve, it is possible that there will be such a small proportion of the electrons making second or third inelastic collisions with normal helium atoms that the curve will show no bends at the electron velocities at which these would normally occur. Thus it was found that when an intense electron stream was used (as in obtaining the curve of fig. 5), the current curve showed a rise at about 55 volts but no bends at 46.0 volts or at 51.2 volts, whereas in curves taken at a similar pressure when a smaller electron current was employed, the former point was not marked but bends at velocities corresponding to multiple collisions were obtained. The absence of the bends at 46.0 volts and at 51.2 volts under the conditions of experiment of fig. 5 may thus be an indication that a large number of collisions with ionized helium atoms is occurring, a condition which is essential to the interpretation we have given of the rise at 55 volts. If this interpretation is correct, it might be expected that there would be some indication of an increase in the measured positive current at an electron velocity, lower than 55 volts, which would correspond to the production of radiation from the ionized helium atom by its collision with an electron. On Bohr's theory such radiation would require for its production an electron velocity of $\frac{3}{4}$ of 54.16 volts = 40.62 volts. The radiation corresponding to this potential difference would be of such high frequency as to be able to ionize some of the normal helium atoms present, and it is therefore uncertain whether its production would show in the current-potential difference curve as an increase of radiation or as an increase of ionization, in a case where the arrangement of the electric fields made it possible to discriminate between these two

effects. The electron velocity at which the bend in the curve is to be expected (40·6 volts) is almost identical with the point at which, under suitable pressure conditions, an increase of radiation should be produced by the second collisions of electrons with normal helium atoms, but the two effects can be distinguished, since the conditions which favour the occurrence of ionization, and which therefore favour the production of the 40·62 volt radiation, are those under which increases of radiation at multiples of the resonance velocity would not be likely to occur to any appreciable extent.

In considering the possibility of detecting the production of a new type of radiation or of fresh ionization from the collisions of electrons with helium atoms which have already lost one electron, the effects of recombination must be taken into account. It is conceivable, for instance, that recombination takes place at all encounters between positively charged helium atoms and electrons with velocities below that necessary for the production of radiation from the charged atom—40·62 volts on Bohr's theory. This being the case, an increased positive current should be measured by the electrometer at 40·62 volts on account of the reduction at this point in the amount of recombination occurring. Whether in this case an increased positive current would also be obtained when the electron velocity is raised to that necessary to remove the second electron from the ionized atom is uncertain, and would depend upon whether the ionization then produced were more than that which the 40·62 volt radiation was producing from the normal helium atoms.

Again, it is possible that an electron which gives rise to 40·62 volt radiation itself recombines with the positively charged helium atom with which it collides. In this case an increased positive current should be obtained when the critical velocity for ionization of the positively charged helium atom is reached, since the encounters would then result in the production of doubly charged helium atoms instead of neutral ones. As the precise conditions under which recombination of a colliding electron and a positively charged helium atom on which it impinges occurs are unknown, it is impossible to predict how the existence of critical velocities at 40·62 volts and 54·16 volts for this atom should be indicated. The curve in fig. 5 shows a bend which we have attributed to the further ionization of the positively charged helium atom, but no bend at all in the neighbourhood of 40 volts. By altering the experimental arrangements we

were able to make a bend show up at this latter point under conditions when it could not be due to a second radiating collision at twice the resonance velocity. A series of observations in which this result was obtained are plotted in the curve of fig. 6. In taking these observations a potential

Fig. 6.

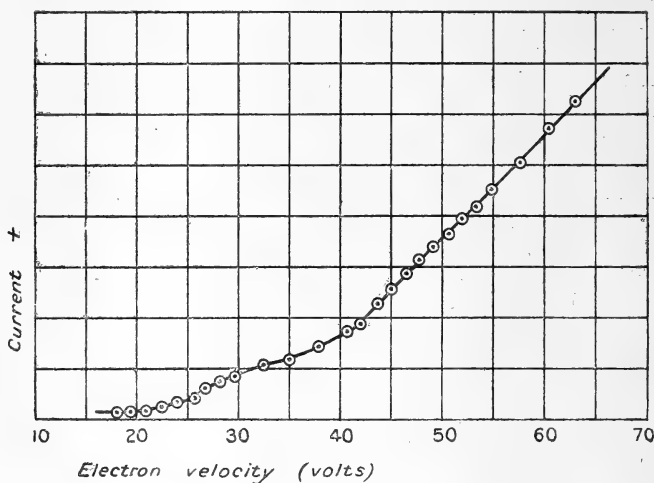

difference of 7 volts was maintained between the gauzes D and C (which in most of the earlier experiments had been at the same potential) in such a direction as to drive positive ions towards the collecting electrode A, and the potential difference V_5 was in the direction for radiation, as well as ionization, to give a positive charge to the electrometer. The gas-pressure (0.170 mm.) was too low for it to be likely that the bend at 41 volts is due to multiple collisions, and it may therefore be taken to indicate a new critical velocity at this point. An upward bend at about 41 volts was obtained in several curves taken under conditions similar to those stated. In some experiments at still lower pressures (about 0.01 mm.) taken with the final field V_5 reversed, a bend in the opposite direction was obtained, showing that radiation was produced at this point, and that at this low pressure its photoelectric effect on the cylinder was greater than the ionization it produced in the gas.

The curves in figs. 5 and 6 may thus be interpreted as supporting the view that at 41 volts and at 55 volts electron collisions with positively charged helium atoms occur, which result in an increased positive current being measured by

the electrometer, as would be expected if radiation and further ionization, respectively, were produced from the ionized atoms at these velocities. Although these results are in agreement with the predictions of Bohr's theory, it is clear that the method of experimenting affords no absolute proof that the observed increase of current does result from such collisions.

In connexion with the increase of current observed at 80 volts, and interpreted as being due to the removal of both electrons from a helium atom at a single electron collision, it might be suggested here also that for some lower electron velocity a single collision should result in the removal of one electron and the displacement of the other to an orbit of greater radius, thus giving both ionization and radiation. Some experiments by Rau* seem to show that collisions producing an effect of this kind do occur under certain conditions. On the basis of Bohr's theory, the electron velocity at which such an effect would be expected is $25.6 \text{ volts} + \frac{3}{4}$ of $54.16 \text{ volts} = 66.22 \text{ volts}$. We were unable to obtain any evidence of this effect in our experiments.

The results described in this paper agree with those of Franck and Knipping in showing that the double ionization of the helium atom results from collisions between helium atoms and electrons having about 80 volts velocity, but differ from theirs in indicating bends in the current curves at 41 volts and 55 volts which appear to be due to the production of radiation and of further ionization, respectively, from the helium atoms which have already lost one electron.

LVIII. *Bromwich's Method of solving Problems in the Conduction of Heat.* By Prof. H. S. CARSLAW, *Sc.D.*†

1. **I**N his paper—"Examples of Operational Methods in Mathematical Physics," *Philosophical Magazine*, No. 220, April 1919—Bromwich advocates the use of so-called operational methods, following Heaviside, in electrical and other physical problems, and illustrates his method by the solution of various questions, including some in the *Conduction of Heat*. In an earlier paper (*Proc. London Math. Soc.* (Ser. 2) xv. p. 401, 1917) he discussed Heaviside's work, and confirmed it by the aid of contour integrals.

The object of the present paper is to illustrate by some

* H. Rau, *Würzburg Phys. Med. ges. Ber.* Feb. 1914.

† Communicated by the Author.

problems in linear flow the method which Bromwich's work has led me to adopt in the discussion of a large class of problems in the Conduction of Heat. It seems to me easier to build up the required solution by integrating a suitable solution over a certain standard path in the plane of the complex variable. The proper particular solution will be easily obtained after a little practice in the method.

The problems in §§ 2, 3, and 4 have been chosen for their simplicity. They are, of course, elementary and solvable by the ordinary methods. The problem in § 5 is here solved for the first time. The corresponding cases for the semi-infinite rod, and the sphere composed of two different materials, can be treated in the same way. These two questions are referred to by Heaviside* in his discussion of the Age of the Earth, following upon Perry's criticism † of Kelvin's classical treatment of this subject.

2. Rod of length a . The ends $x=0$ and $x=a$ kept at temperatures zero and v_0 respectively. The initial temperature zero.

Let the temperature at the point x at the time t be v .
Then the equations are as follows:—

$$\frac{\partial v}{\partial t} = \kappa \frac{\partial^2 v}{\partial x^2}, \quad 0 < x < a. \quad \dots \dots (1)$$

$$v = 0, \quad \text{when } x = 0. \quad \dots \dots (2)$$

$$v = v_0, \quad \text{when } x = a. \quad \dots \dots (3)$$

$$v = 0, \quad \text{when } t = 0. \quad \dots \dots (4)$$

Fig. 1.

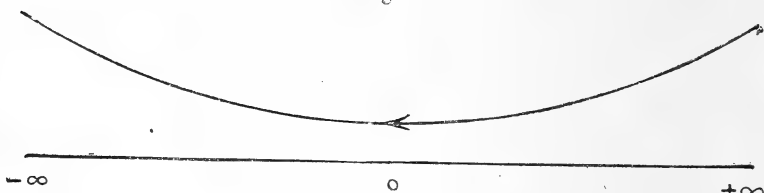

The path (P) in the α -plane.

Consider the value of v given by the integral

$$v = \frac{v_0}{i\pi} \int \frac{\sin \alpha x e^{-\kappa \alpha^2 t}}{\sin \alpha a \alpha} d\alpha \quad \dots \dots (5)$$

over the path (P) of fig. 1 in the α -plane. In this path the

* Heaviside, 'Electromagnetic Theory,' Vol. II. Chapter v. Cf. §§ 229, 230.

† 'Nature,' li. p. 224 et seq. (1895).

argument of α on the right must lie between 0 and $\frac{1}{4}\pi$, and on the left between $\frac{3}{4}\pi$ and π . We take the path (P) of fig. 1 as the standard path in the problems which follow.

Since every element of the integral satisfies (1), the value of v in (5) satisfies (1).

Also when $x=0$, we have $v=0$.

And when $x=a$, $v = \frac{v_0}{i\pi} \int \frac{e^{-\kappa\alpha^2 t}}{\alpha} d\alpha$, over the path (P). (6)

Since the integrand is an odd function of α , if we form the path (Q) by taking the image of the path (P) in the real

Fig. 2.

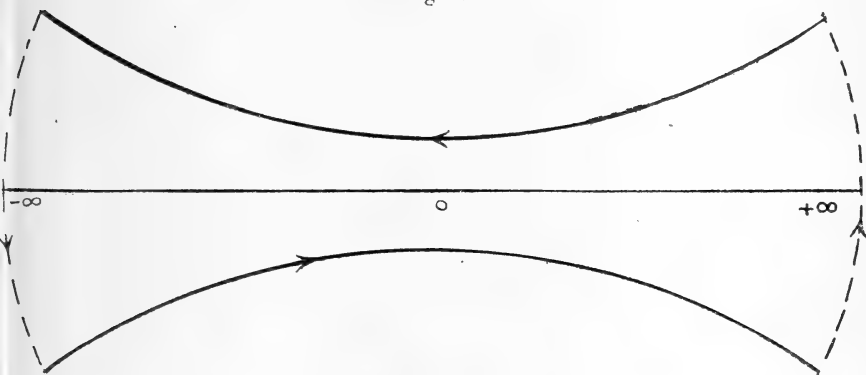

The path (Q) in the α -plane.

axis of α , joining the ends of the path (P) and its image by arcs of a circle, centre at the origin, whose radius tends to infinity, we have from (6)

$$v = \frac{v_0}{2i\pi} \int \frac{e^{-\kappa\alpha^2 t}}{\alpha} d\alpha, \text{ over the path (Q),}$$

since the integrals over the circular arcs vanish in the limit.

Therefore when $x=a$, we have $v=v_0$.

Finally, when $t=0$, we have

$$v = \frac{v_0}{i\pi} \int \frac{\sin \alpha x}{\sin \alpha a} \frac{d\alpha}{\alpha}, \text{ over the path (P).}$$

Now the integrand has no infinities above the path (P), and if we complete the circuit by the arc of a circle, dotted in fig. 3, whose centre lies at the origin and radius tends to infinity, the integral over the complete path of fig. 3 is zero.

But the integral over the dotted path vanishes in the limit. Therefore $v=0$, when $t=0$.

It follows that the value of v given by (5) satisfies all the conditions of our problem.

Fig. 3.

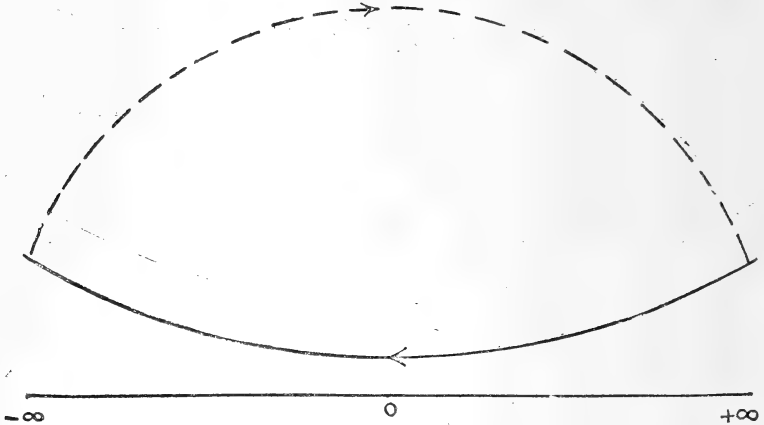

The solution obtained in (5) as a contour integral is transformed into an infinite series by Cauchy's Theorem, using the path (Q) of fig. 2.

For we have

$$v = \frac{v_0}{2i\pi} \int \frac{\sin \alpha x e^{-\kappa \alpha^2 t}}{\sin \alpha a \alpha} d\alpha, \text{ over the path (Q),}$$

$$= v_0 \left[\frac{x}{a} + \frac{2}{\pi} \sum_1^{\infty} \frac{(-1)^n}{n} \sin \frac{n\pi}{a} x e^{-\kappa \frac{n^2 \pi^2}{a^2} t} \right].$$

3. *The same rod. The end $x=0$ kept at zero; radiation into a medium at v_0 at the end $x=a$. The initial temperature zero.*

Here we have to solve:—

$$\frac{\partial v}{\partial t} = \kappa \frac{\partial^2 v}{\partial x^2}, \quad 0 < x < a. \dots \dots \dots (1)$$

$$v = 0, \quad \text{when } x = 0. \dots \dots \dots (2)$$

$$\frac{\partial v}{\partial x} + h(v - v_0) = 0, \quad \text{when } x = a. \dots \dots (3)$$

$$v = 0, \quad \text{when } t = 0. \dots \dots \dots (4)$$

Starting from the solution of (1)

$$A \sin \alpha x e^{-\kappa \alpha^2 t}$$

which vanishes at $x=0$, we are led by (3) to choose A so that

$$\alpha A \cos \alpha a + h(A \sin \alpha a - v_0) = 0 ;$$

$$i. e. \quad A = \frac{h v_0}{\alpha \cos \alpha a + h \sin \alpha a}.$$

This brings us to the solution of our problem in the form

$$v = \frac{h v_0}{i \pi} \int \frac{\sin \alpha x}{\alpha \cos \alpha a + h \sin \alpha a} \frac{e^{-\kappa \alpha^2 t}}{\alpha} d\alpha, \quad \text{over the path (P).} \quad (5)$$

It can be shown just as in § 2 that the value of v given in (5) as a contour integral satisfies all the conditions of the problem, for the roots of the equation

$$\alpha \cos \alpha a + h \sin \alpha a = 0 \quad (6)$$

are all real*, and in the integral

$$\int \frac{\sin \alpha x}{\alpha \cos \alpha a + h \sin \alpha a} \frac{d\alpha}{\alpha}$$

the path (P) can be replaced by the dotted part of fig. 3, so that, when the radius tends to infinity, this integral vanishes.

Finally the solution obtained in (5) reduces as in § 2, by Cauchy's Theorem, to a infinite series, and we have

$$v = h v_0 \left[\frac{v}{1 + ha} + 2 \sum_1^{\infty} \frac{(-1)^n \sqrt{(\alpha_n^2 + h^2)}}{(h(1 + ha) + a \alpha_n^2)} \frac{\sin \alpha_n x}{\alpha_n} e^{-\kappa \alpha_n^2 t} \right],$$

the summation being taken over the positive roots of (6).

4. If the end $x=a$ is kept at temperature Ct , or radiation takes place there into a medium at temperature Ct , the solutions corresponding to § 2 (5) and § 3 (5) will be seen to be

$$v = - \frac{C}{\kappa i \pi} \int \frac{\sin \alpha x}{\sin \alpha a} \frac{e^{-\kappa \alpha^2 t}}{\alpha^3} d\alpha,$$

$$v = - \frac{Ch}{\kappa i \pi} \int \frac{\sin \alpha x}{\alpha \cos \alpha a + h \sin \alpha a} \frac{e^{-\kappa \alpha^2 t}}{\alpha^3} d\alpha,$$

respectively, the integrals being taken over the standard path (P).

These can be reduced to infinite series as before, by introducing the path (Q).

* Cf. Carslaw, 'Fourier's Series and Integrals,' § 133.

5. Rod of length b composed of two different materials. The ends $x=0$ and $x=b$ kept at zero and v_0 respectively. The initial temperature zero.

Let v_1 be the temperature in the first part of the rod ($0 < x < a$), and K_1, c_1, ρ_1 be its conductivity, specific heat, and density. Let v_2 be the temperature in the other part ($a < x < b$), and K_2, c_2, ρ_2 the corresponding constants therein.

Also let $\kappa_1 = K_1/c_1\rho_1$ and $\kappa_2 = K_2/c_2\rho_2$.

The equations for the temperature are as follows:—

$$(1) \quad \frac{\partial v_1}{\partial t} = \kappa_1 \frac{\partial^2 v_1}{\partial x^2}, \quad 0 < x < a: \quad \frac{\partial v_2}{\partial t} = \kappa_2 \frac{\partial^2 v_2}{\partial x^2}, \quad a < x < b. \quad (1')$$

$$(2) \quad v_1 = 0, \quad \text{when } x = 0: \quad v_2 = v_0, \quad \text{when } x = b. \quad (2')$$

$$(3) \quad v_1 = 0, \quad \text{when } t = 0: \quad v_2 = 0, \quad \text{when } t = 0. \quad (3')$$

$$v_1 = v_2, \quad \text{when } x = a. \quad \dots \dots \dots (4)$$

$$K_1 \frac{\partial v_1}{\partial x} = K_2 \frac{\partial v_2}{\partial x}, \quad \text{when } x = a. \quad \dots \dots \dots (5)$$

It is clear that

$$v_1 = A_1 \sin \alpha x e^{-\kappa_1 \alpha^2 t},$$

$$\text{and } v_2 = (A_2 \sin \mu \alpha (x - a) + B_2 \sin \mu \alpha (b - x)) e^{-\kappa_1 \alpha^2 t},$$

satisfy (1) and (1'), when $\mu = \sqrt{(\kappa_1/\kappa_2)}$.

They also satisfy (4) and (5), provided that

$$A_1 \sin \alpha a = B_2 \sin \mu \alpha (b - a),$$

$$\text{and } K_1 A_1 \cos \alpha a = K_2 \mu (A_2 - B_2 \cos \mu \alpha (b - a)).$$

Therefore we take

$$A_2 = (\sigma \cos \alpha a + \sin \alpha a \cot \mu \alpha (b - a)) A_1,$$

$$\text{and } B_2 = \frac{\sin \alpha a}{\sin \mu \alpha (b - a)} A_1,$$

$$\text{where } \sigma = \frac{K_1}{K_2 \mu} = \sqrt{\left(\frac{K_1 c_1 \rho_1}{K_2 c_2 \rho_2}\right)}.$$

Introducing the path (P) and choosing a suitable value for A_1 , we are led to the solution:—

$$v_1 = \frac{v_0}{i\pi} \int \frac{\sin \alpha x}{F(\alpha)} \frac{e^{-\kappa_1 \alpha^2 t}}{\alpha} d\alpha \quad \dots \dots \dots (6)$$

$$v_2 = \frac{i\pi}{v_0} \left(\frac{\sin \mu \alpha (x - a)}{\sin \mu \alpha (b - a)} + \frac{\sin \alpha a \sin \mu \alpha (b - x)}{F(\alpha) \sin \mu \alpha (b - a)} \right) \frac{e^{-\kappa_1 \alpha^2 t}}{\alpha} d\alpha, \quad (7)$$

where

$$F(\alpha) = \sigma \cos \alpha a \sin \mu \alpha (b-a) + \sin \alpha a \cos \mu \alpha (b-a),$$

and these integrals are taken over the standard path (P).

The second integral reduces to

$$v_2 = \frac{v_0}{i\pi} \int \frac{\sigma \cos \alpha a \sin \mu \alpha (x-a) + \sin \alpha a \cos \mu \alpha (x-a)}{\sigma \cos \alpha a \sin \mu \alpha (b-a) + \sin \alpha a \cos \mu \alpha (b-a)} \frac{e^{-\kappa_1 \alpha^2 t}}{\alpha} d\alpha \quad (8)$$

over the path (P). The values v_1 and v_2 given in (6) and (8) satisfy all the conditions of our problem: for, from the way in which they have been built up, they obviously satisfy the differential equations (1) and (1'), and (2), (4), and (5).

Further, putting $x=b$ in (8), we have $v=v_0$.

We shall prove below that the roots of the equation

$$F(\alpha) \equiv \sigma \cos \alpha a \sin \mu \alpha (b-a) + \sin \alpha a \cos \mu \alpha (b-a) = 0 \quad (9)$$

are infinite in number, all real and not repeated, and it is clear that to each positive root there corresponds an equal and opposite negative root.

Assuming this to be the case, the same argument as in § 2 will show that the initial conditions (3) and (3') are satisfied.

Finally, the solution is obtained as an infinite series. For we have, from (6) and (8),

$$v_1 = \frac{v_0}{2i\pi} \int \frac{\sin \alpha x e^{-\kappa_1 \alpha^2 t}}{F(\alpha) \alpha} d\alpha,$$

$$v_2 = \frac{v_0}{2i\pi} \int \frac{\sigma \cos \alpha a \sin \mu \alpha (x-a) + \sin \alpha a \cos \mu \alpha (x-a)}{F(\alpha)} \frac{e^{-\kappa_1 \alpha^2 t}}{\alpha} d\alpha,$$

over the path (Q) of fig. 2.

Therefore

$$v_1 = \frac{v_0 x}{\sigma \mu (b-a) + a} + 2v_0 \sum_1^{\infty} \frac{\sin \alpha_n x e^{-\kappa_1 \alpha_n^2 t}}{F'(\alpha_n) \alpha_n},$$

$$v_2 = v_0 \frac{\sigma \mu (x-a) + a}{\sigma \mu (b-a) + a}$$

$$+ 2v_0 \sum_1^{\infty} \frac{\sigma \cos \alpha_n a \sin \mu \alpha_n (x-a) + \sin \alpha_n a \cos \mu \alpha_n (x-a)}{F'(\alpha_n)} \frac{e^{-\kappa_1 \alpha_n^2 t}}{\alpha_n},$$

the summation being taken over the positive roots of (9).

6. It remains to discuss the roots of the equation

$$F(\alpha) \equiv \sigma \cos \alpha a \sin \mu \alpha (b-a) + \sin \alpha a \cos \mu \alpha (b-a) = 0.$$

From the graphs of

$$y = \sigma \cot \alpha a$$

and $\dots \dots y = -\cot \mu \alpha (b-a)$

it is clear that there are infinite number of real roots, and the position of the same can be determined.

Also $F(\alpha)$ is an odd function of α and the real roots may be denoted by

$$0, \pm \alpha_1, \pm \alpha_2, \dots$$

By examining $F'(\alpha)$, it will be seen that these roots are not repeated.

Also it is clear that $F(\alpha)$ has no pure imaginary root. We have now to show that it has no roots of the form $\xi \pm i\eta$.

Consider the functions U_1, U_2 defined as follows:—

$$U_1 = \sin \alpha x, \quad 0 < x < a$$

$$U_2 = \frac{\sin \mu \alpha (b-x)}{\sin \mu \alpha (b-a)} \sin \alpha a, \quad a < x < b,$$

where α is a root of $F(\alpha) = 0$,

and $\sigma = K_1/K_2\mu, \quad \mu = \sqrt{(\kappa_1/\kappa_2)}$.

Then we have

$$\frac{d^2 U_1}{dx^2} + \alpha^2 U_1 = 0, \quad 0 < x < a; \dots \dots (1)$$

$$\frac{d^2 U_2}{dx^2} + \mu^2 \alpha^2 U_2 = 0, \quad 0 < x < b. \dots \dots (2)$$

Also $U_1 = 0$, when $x = 0. \dots \dots (3)$

$$\left. \begin{array}{l} U_1 = U_2 \\ K_1 \frac{dU_1}{dx} = K_2 \frac{dU_2}{dx} \end{array} \right\} \text{when } x = a. \dots \dots (4)$$

And $U_2 = 0$, when $x = b. \dots \dots (5)$

Let β be another root of $F(\alpha) = 0$, and V_1, V_2 the corresponding functions.

Then we have, from (1) and (2),

$$\frac{\mu}{\sigma}(\alpha^2 - \beta^2) \int_a^b U_2 V_2 dx + \frac{1}{\sigma\mu} \int_a^b (V_2 U_2'' - U_2 V_2'') dx = 0,$$

and

$$(\alpha^2 - \beta^2) \int_0^a U_1 V_1 dx + \int_0^a (V_1 U_1'' - U_1 V_1'') dx = 0.$$

Therefore

$$\begin{aligned} (\alpha^2 - \beta^2) & \left[\int_0^a U_1 V_1 dx + \frac{\mu}{\sigma} \int_a^b U_2 V_2 dx \right] \\ & = \int_0^a (U_1 V_1'' - V_1 U_1'') dx + \frac{1}{\sigma\mu} \int_a^b (U_2 V_2'' - V_2 U_2'') dx \\ & = \left[U_1 V_1' - V_1 U_1' \right]_0^a + \frac{K_2}{K_1} \left[U_2 V_2' - V_2 U_2' \right]_a^b. \end{aligned}$$

It follows from (3), (4), and (5), that

$$(\alpha^2 - \beta^2) \left[\int_0^a U_1 V_1 dx + \frac{\mu}{\sigma} \int_a^b U_2 V_2 dx \right] = 0.$$

Thus $F(\alpha) = 0$ cannot have imaginary roots of the form $\xi \pm i\eta$.

LIX. *The Mass-Spectra of Chemical Elements.* By F. W. ASTON, M.A., D.Sc., Clerk Maxwell Student of the University of Cambridge*.

[Plate XV.]

THE following paper is an account of some results obtained by the analyses of gases by means of the Positive Ray Spectrograph or, as it may be more conveniently termed, Mass-Spectrograph. The principle of the method by which a focussed spectrum is obtained depending solely on the ratio of mass to charge has already been described †, but for the sake of others experimenting in this field it is now proposed to give an account of the actual apparatus in some detail.

* Communicated by the Author.

† F. W. A., Phil. Mag. xxxviii. Dec. 1919, p. 707.

The Discharge Tube.

Fig. 1 is a rough diagram of the present arrangement. The discharge-tube B is an ordinary X-ray bulb 20 cm. in diameter. The anode A is of aluminium wire 3 mm.

Fig. 1.

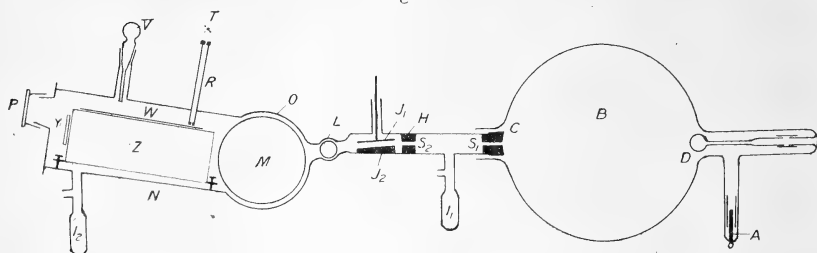

thick surrounded concentrically by an insulated aluminium tube 7 mm. wide to protect the glass walls, as in the Lodge valve.

The aluminium cathode C, 2.5 cm. wide, is concave, about 8 cm. radius of curvature, and is placed just in the neck of the bulb—this shape and position having been adopted after a short preliminary research*. In order to protect the opposite end of the bulb, which would be immediately melted by the very concentrated beam of cathode rays, a silica bulb D about 12 mm. diameter is mounted as indicated. The use of silica as an anticathode was suggested by Prof. Lindemann, and has the great advantage of cutting down the production of undesirable X rays to a minimum.

The discharge is maintained by means of a large induction-coil actuated by a mercury coal-gas break; about 100 to 150 watts are passed through the primary, and the bulb is arranged to take from 0.5 to 1 milliampere at potentials ranging from 20,000 to 50,000 volts. Owing to the particular shape and position of the electrodes, especially those of the anode, the bulb acts perfectly as its own rectifier.

The method of mounting the cathode will be readily seen from fig. 2, which shows part of the apparatus in greater detail. The neck of the bulb is ground off short and cemented with wax to the flat brass collar E, which forms the mouth of an annular space between a wide outer tube F and the inner tube carrying the cathode.

* F. W. A., Proc. Camb. Phil. Soc. xix. p. 317.

The concentric position of the neck is assured by three small ears of brass not shown. The wax joint is kept cool by circulating water through the copper pipe shown in section at G.

Fig. 2.

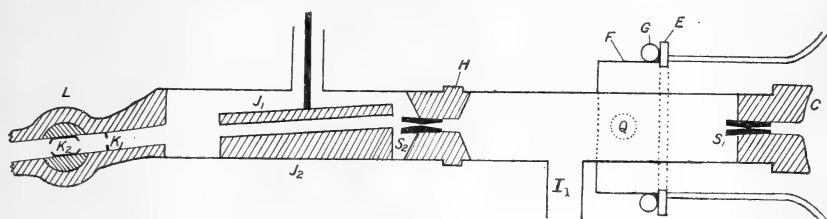

The gas to be analysed is admitted from the customary fine leak into the annular space and so to the discharge by means of the side-tube attached to F shown in dotted section at Q. Exhaustion is performed by a Gaede mercury-pump through a similar tube on the opposite side. The reason for this arrangement is that the space behind the cathode is the only part of the discharge bulb in which the gas is not raised to an extremely high potential. If the inlet or outlet is anywhere in front of the cathode, failing special guards, the discharge is certain to strike to the pump or the gas reservoir. Such special guards have been made in the past by means of dummy cathodes in the bore of the tubes, but, notwithstanding the fact that the gas can only reach the bulb by diffusion, the present arrangement is far more satisfactory and has the additional advantage of enabling the bulb to be dismantled by breaking one joint only.

The Slit System.

The centre of the cathode is pierced with a 3 mm. hole, the back of which is coned out to fit one of the standard slits S_1^* . The back of the cathode is turned a gas-tight fit in the brass tube 2 cm. diameter carrying it, the other end of which bears the brass plug H which is also coned and fitted with the second slit S_2 . The two slits, which are .05 mm. wide by 2 mm. long; can be accurately adjusted parallel by means of their diffraction patterns. The space between the slits, which are about 10 cm. apart, is kept exhausted to the highest degree by the charcoal tube I_1 .

* F. W. A., *Phil. Mag.* xxxviii. Dec. 1919, p. 714.

By this arrangement it will be seen that not only is loss of rays by collision and neutralization reduced to a minimum, but any serious leak of gas from the bulb to the camera is eliminated altogether.

The Electric Field.

The spreading of the heterogeneous ribbon of rays formed by the slits into an electric spectrum takes place between two parallel flat brass surfaces, J_1 , J_2 , 5 cm. long, held 2.8 mm. apart by glass distance-pieces, the whole system being wedged immovably in the brass containing-tube in the position shown. The lower surface is cut from a solid cylinder fitting the tube and connected to it and earth. The upper surface is a thick brass plate, which can be raised to the desired potential by means of a set of small storage-cells. In order to have the plates as near together as possible, they are sloped at 1 in 20—*i. e.*, half the angle of slope of the mean ray of the part of the spectrum which is to be selected by the diaphragms. Of these there are two: one, K_1 , an oblong aperture in a clean brass plate, is fixed just in front of the second movable one, K_2 , which is mounted in the bore of a carefully ground stopcock L. The function of the first diaphragm is to prevent any possibility of charged rays striking the greasy surface of the plug of the stopcock when the latter is in any working position. The variable diaphragm is in effect two square apertures sliding past each other as the plug of the stopcock is turned, the fact that they are not in the same plane being irrelevant. When the stopcock is fully open as sketched in fig. 2, the angle of rays passing is a maximum, and may be stopped down to any desired extent by rotation of the plug, becoming zero before any greasy surface is exposed to the rays. Incidentally the stopcock serves another and very convenient use, which is to cut off the camera from the discharge-tube, so that the latter need not be filled with air each time the former is opened to change the plate.

The Magnetic Field.

After leaving the diaphragms the rays pass between the pole-pieces M of a large Du Bois magnet of 2500 turns. The faces of these are circular, 8 cm. diameter, and held 3 mm. apart by brass distance-pieces. The cylindrical pole-pieces themselves are soldered into a brass tube O, which forms part of the camera N. When the latter is built into position, the pole-pieces are drawn by screwed

bolts into the arms of the magnet, and so form a structure of great weight and rigidity and provide an admirable foundation for the whole apparatus. Current for the magnet is provided by a special set of large accumulators. The hydrogen lines are brought on to the plate at about 0.2 ampere, and an increase to 5 amperes, which gives practical saturation, only just brings the singly-charged mercury lines into view. The discharge is protected from the strong field of the magnet by the usual soft iron plates, not shown.

The Camera.

The main body of the camera N is made of stout brass tube 6.4 cm. diameter, shaped to fit on to the transverse tube O containing the pole-pieces. The construction of the plate-holder is indicated by the side view in fig. 1 and an end-on view in fig. 3. The rays after being magnetically deflected

Fig. 3.

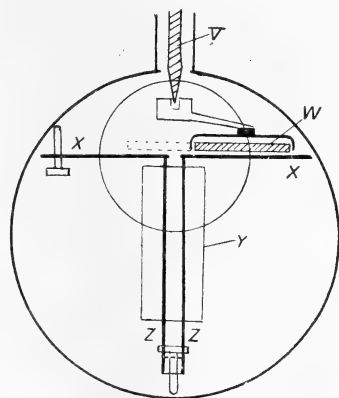

pass between two vertical brass plates Z, Z about 3 mm. apart, and finally reach the photographic plate through a narrow slot 2 mm. wide, 11.8 cm. long, cut in the horizontal metal plate X, X. The three brass plates forming a T-shaped girder are adjusted and locked in position by a set of three levelling-screws at each end; the right-hand upper one is omitted in fig. 3. The plates Z, Z serve to protect the rays completely from any stray electric field, even that caused by the photographic plate itself becoming charged, until within a few millimetres of their point of impact.

The photographic plate W, which is a 2 cm. strip cut

lengthwise from a 5×4 plate, is supported at its ends on two narrow transverse rails which raise it just clear of the plate XX. Normally it lies to the right of the slot as indicated, and to make an exposure it is moved parallel to itself over the slot by means of a sort of double lazy-tongs carrying wire claws which bracket the ends of the plate as shown. This mechanism, which is not shown in detail, is operated by means of a torque rod V working through a ground glass joint. Y is a small willemite screen.

The adjustment of the plate-holder so that the sensitized surface should be at the best focal plane was done by taking a series of exposures of the bright hydrogen lines with different magnetic fields on a large plate placed in the empty camera at a small inclination to the vertical. On developing this, the actual track of the rays could be seen and the locus of points of maximum concentration determined. The final adjustment was made by trial and error and was exceedingly tedious, as air had to be admitted and a new plate inserted after each tentative small alteration of the levelling-screws.

Experimental procedure.

The plate having been dried in a high vacuum overnight, the whole apparatus is exhausted as completely as possible by the pump with the stopcock L open. I_1 and I_2 are then cut off from the pump by stopcocks and immersed in liquid air for an hour or so. The electric field, which may range from 200 to 500 volts, is then applied and a small current passed through the magnet sufficient to bring the bright hydrogen molecule spot on to the willemite screen Y, where it can be inspected through the plate-glass back of the cap P. In the meantime the leak, pump, and coil have all been started to get the bulb into the desired state.

As soon as this is obtained and has become steady, J_1 is earthed to prevent any rays reaching the camera when the plate is moved over the slot to its first position, which is judged by inspection through P with a non-actinic lamp. The magnet current having been set to the particular value desired and the diaphragm adjusted, the coil is momentarily interrupted while J_1 is raised to the desired potential, after which the exposure starts. During this, preferably both at the beginning and the end, light from a lamp T is admitted for a few seconds down the tube R (fig. 1) the ends of

which are pierced with two tiny circular holes. The lower hole is very close to the plate, so that a circular dot or register spot is formed from which the measurements of the lines may be made.

The exposures may range from 20 seconds in the case of hydrogen lines to 30 minutes or more, 15 minutes being usually enough. As soon as it is complete the above procedure is repeated, and the plate moved into the second position. In this way as many as six spectra can be taken on one plate, after which L is shut, I_2 warmed up, and air admitted to the camera. The cap P, which is on a ground joint, can now be removed, and the exposed plate seized and taken out with a special pair of forceps. A fresh plate is now immediately put in, P replaced, and the camera again exhausted, in which state it is left till the next operation.

Form of the Spectrum Lines.

As has been shown (Phil. Mag. Dec. 1919, plate ix.), the shape of the spot formed when undeflected rays from such a slit system strike a photograph surface normally, is somewhat as indicated at *a* (fig. 4). When they strike the plate obliquely the image would be spread out in one direction, as in *b*. This would be the actual form in the apparatus, if the

Fig. 4.

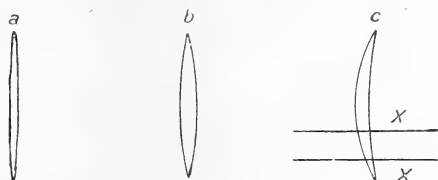

deflexions of the mean and extreme rays (*i. e.*, the rays forming the centre and the tips) were identical. This is true of the magnetic field since each cuts the same number of lines of force; but it is not so in the case of the electric deflexion. Since the form of the plates, and therefore roughly of the boundaries of the field, is rectangular, the extreme rays passing diagonally will be deflected more than the mean rays and the spot bent into the form shown at *c*. The convex side will be in the direction of the magnetic deflexion, as this is opposed to the deflexion causing the

bend. The image on the plate will therefore be the part of this figure falling on the narrow slot in X, X; and as the apparatus is not exactly symmetrical, its shape in the spectra is the figure lying between the lines X, X in fig. 4, c.

Measurement of the Lines.

The plates are measured against a standard Zeiss scale on a comparator designed by the late Dr. Keith Lucas and kindly lent by the Physiological Department. Some of the very faint lines, although easily visible to the unaided eye, were lost even with the lowest power eyepieces obtainable. To measure these, an eyepiece giving a magnification of about $2\frac{1}{2}$ was designed by Dr. Hartridge of King's College.

The general method of deducing mass from position has already been described (Phil. Mag. April 1920, p. 453). Owing to some geometrical cause (probably analogous to a caustic in optics), the more deflected edge of the line is always the brighter and sharper, and it is the distance of this from the register spot which is found to give the most reliable values. For the highest accuracy, owing to halation, one must only compare lines of approximately equal intensity. As this edge is unfortunately not at right angles to the spectrum, measurements can never be regarded as absolute, unless extreme care is taken in the levelling of the spectrum on the comparator. So although theoretically it is sufficient to know the mass of one line to determine (with the correction curve) those of all others, in practice every effort is made to bracket any unknown line by reference lines, and only to trust comparative measurements when the lines are fairly close together. Under these conditions the accuracy claimed for the instrument is about one part in a thousand.

Order of Results and Nomenclature.

The various elements studied will be considered as far as possible in the order in which the experiments were performed. This order is of considerable importance, as in most cases it was impossible to eliminate any element used before the following one was introduced. Evacuation and washing have little effect, as the gases appear to get embedded in the surface of the discharge-bulb and are only released very gradually by subsequent discharge.

The problem of nomenclature became serious when the very complex nature of the heavy elements was apparent,

After several possible systems had been discussed it was decided, for the present, to adopt the rather clumsy but definite and elastic one of using the chemical symbol of the mixed element with an index corresponding to its mass : *e.g.*, Ne^{22} , Kr^{84} . This system is made reasonable by the fact that the masses of constituents of mixed elements have all so far proved whole numbers on the scale used.

In cases of particles carrying more than one charge it will be convenient to borrow the nomenclature of optics and refer to the lines given by singly, doubly, and multiply charged particles respectively as lines of the first, second, and higher orders. Thus the molecule of oxygen gives a first order line at 32, and its atom first and second order lines at 16 and 8.

The empirical rule that molecules only give first order lines (J. J. Thomson, 'Rays of Positive Electricity,' p. 54) is very useful in helping to differentiate between elementary atoms and compound molecules of the same mass. Some very recent results give indications that in certain exceptional cases it may break down, so that inferences made from it must not be taken as being absolutely conclusive.

OXYGEN (At. Wt. 16.00) and CARBON (At. Wt. 12.00).

On a mass-spectrum all measurements are relative, and so any known element could be taken as a standard. Oxygen is naturally selected. Its molecule, singly-charged atom, and doubly-charged atom give reference lines at 32, 16, and 8 respectively. The extremely exact integral relation between the atomic weights of oxygen and carbon is itself strong evidence that both are "pure" elements, and so far no evidence appears to have arisen to throw any doubt on this point. Direct comparison of the C line (12) and the CO line (28) with the above standards shows that the expected whole number relation and additive law hold to the limit of accuracy, *i. e.* one part in a thousand ; and this provides standards C^{++} (6), C (12), CO (28), and CO_2 (44). In a similar manner, hydrocarbons give the C_1 and C_2 groups already mentioned (Phil. Mag. April 1920, pp. 452, 453) ; so that a fairly complete scale of reference is immediately available.

NEON (At. Wt. 20.20).

The results obtained with this gas have already been fully dealt with (Phil. Mag. April 1920, p. 449). It has been shown to consist of two isotopes of masses 20 and 22 respectively, with the faint possibility of a third of mass 21.

Spectrum I. on Pl. XV. shows the singly-charged lines of neon, to the left of the C_2 group. It is reproduced here to show the condition of the discharge-tube immediately before compounds of chlorine were introduced.

CHLORINE (At. Wt. 35.46).

Spectra indicating that this element was a mixture of isotopes were first obtained by the use of hydrochloric acid gas, but as this was objectionable on account of its action on mercury, phosgene ($COCl_2$) was substituted. Spectra II., III., and IV. are reproduced from one of the plates taken with this gas. It will be seen that chlorine is characterized by the appearance of four very definite lines in the previously unoccupied space to the right of O_2 (32): measurement shows these lines to correspond exactly to masses 35, 36, 37, and 38. *There is no indication whatever of a line at a point corresponding with the accepted atomic weight 35.46.* On Spectrum II., taken with a small magnetic field, faint lines will be seen at 17.5 and 18.5. These only appeared when chlorine was introduced, and are certainly second order lines corresponding to 35 and 37. These figures seem to leave no possible escape from the conclusion that chlorine is a mixture of isotopes and that two of these have masses 35 and 37. It might be argued that 36 and 38 are also elementary lines and at present there is no evidence to deny this, but it is much more probable that they are the hydrochloric acids HCl^{35} and HCl^{37} . The line 18 is no indication of an element 36, as it is doubtless due to OH_2 . Corroborative evidence that Cl^{35} and Cl^{37} are the main if not the only constituents is given by the strong lines 63 and 65 (Spectrum IV.) probably due to $COCl^{35}$ and $COCl^{37}$. If chemical atomic weight is regarded as a statistical average, any lines due to Cl^{35} or its compounds should be considerably stronger than the corresponding ones due to Cl^{37} . This is actually found to be the case. In all spectra taken with chlorine present a faint line is distinguishable corresponding to 39. It is just possible that this is a third isotope.

The unquestionable accuracy of its combining weight on the one hand and the striking whole-number masses given on its mass-spectra by its individual particles on the other, leave little doubt that chlorine is a mixed element, but much critical work will be necessary before its constituents and their relative proportions are decided with certainty.

ARGON (At. Wt. 39.88 Ramsay, 39.91 Ledue).

At the close of the experiments with phosgene the discharge-tube broke down and had to be cleaned and partially rebuilt,

so that by the time it had reached suitable working conditions again, all traces of chlorine had disappeared. The tube was run with a mixture of CO_2 and CH_4 , and then about 20 per cent. of argon added. The main constituent of the element was at once evident from a very strong line at 40 (Spectrum VI.) reproduced in the second and third orders at 20 and 13.33 (Spectrum V.). The third order line is exceedingly well placed for measurement, and from it the mass of the singly-charged atom is found to be $40.00 \pm .02$. At first this was thought to be the only constituent, but later a faint companion was seen at 36, which further spectra showed to bear a very definite intensity relation to the 40 line. No evidence drawn from multiple charges is available in this case owing to the probable presence of OH_2 and C; but the above intensity relation and the absence of the line from spectra taken just before argon was introduced, make it extremely likely that it is a true isotope. The presence of about 3 per cent. would account for the fractional atomic weight determined from density.

NITROGEN (At. Wt. 14.01).

This element shows no abnormal characteristics: its atom cannot be distinguished, on the present apparatus, from CH_2 nor its molecule from CO. Its second order line on careful measurement appears to be exactly 7, so it is evidently a pure element, as its chemical combining weight would lead one to expect.

HYDROGEN (At. Wt. 1.008) and HELIUM (At. Wt. 3.99).

The determination of masses so far removed as these from the reference lines offers peculiar difficulties, but, as the lines were expected to approximate to the terms of the geometrical progression 1, 2, 4, 8, etc. the higher terms of which are known, a special method was adopted by which a two to one relation could be tested with some exactness. Two sets of accumulators were selected, each giving very nearly the same potential of about 250 volts. The potentials were then made exactly equal by means of a subsidiary cell and a current-divider, the equality being tested to well within 1 in 1000 by means of a null instrument. If exposures are made with such potentials applied to the electric plates first in parallel and then in series, the magnetic field being kept constant, all masses having an exact two to one relation will be brought into coincidence on the plate (Phil. Mag. April 1920, p. 453). Such

coincidences cannot be detected on the same spectrum photographically; but if we first add and then subtract a small potential from one of the large potentials, two lines will be obtained which closely bracket the third. To take an actual instance—with a constant current in the magnet of 0.2 ampere, three exposures were made with a gas containing hydrogen and helium at potentials of 250, 500+12, and 500-12 volts respectively. The hydrogen molecule line was found symmetrically bracketed by a pair of atomic lines (Spectrum VII. *a* and *c*), showing that the mass of the molecule is exactly double the mass of the atom within experimental error. When after a suitable increase of the magnetic field the same procedure was applied to the helium line and that of the hydrogen molecule, the bracket was no longer symmetrical (Spectrum VII. *b*), nor was it when the hydrogen molecule was bracketed by two helium lines (*d*). Both results show in an unmistakable manner that the mass of He is less than twice that of H₂. In the same way He was compared with O⁺⁺, and H₃, obtained from KOH by Sir J. J. Thomson's bombardment method, with C⁺⁺.

The method has some definite advantages and some disadvantages. It is not proposed to discuss these in detail at present. The values obtained by its use can be checked in the ordinary way by comparing He with C⁺⁺ and H₃ with He, these pairs being close enough together for the purpose. The following table gives the range of values obtained from the most reliable plates:—

Line	Method.	Mass assumed.	Mass deduced.
He	{ bracket	O ⁺⁺ = 8	3.994—3.996
	{ direct	C ⁺⁺ = 6	4.005—4.010
H ₃	{ bracket	C ⁺⁺ = 6	3.025—3.027
	{ direct	He = 4	3.021—3.030
H ₂	bracket	He = 4	2.012—2.018

From these figures it is safe to conclude that hydrogen is a "pure" element and that its atomic weight, determined with such consistency and accuracy by chemical methods (1.008), is the true mass of its atom.

The above results incidentally appear to settle the nature of the molecule H₃ beyond doubt.

KRYPTON (At. Wt. 82.92) and XENON (At. Wt. 130.2).

The results with these elements were particularly interesting. The only source available, for which the author is indebted to Sir J. J. Thomson, was the remains of two small samples of gas from evaporated liquid air kindly supplied by Sir James Dewar some years ago for examination by the "parabola" method. Both samples contained nitrogen, oxygen, argon, and krypton, but xenon was only detected in one and its percentage in that must have been quite minute. Krypton is characterized by a remarkable group of five strong lines at 80, 82, 83, 84, 86, and a faint sixth at 78. This group or cluster of isotopes is beautifully reproduced with the same relative values of intensity in the second, and fainter still in the third order. These multiply-charged clusters give most reliable values of mass, as the second order can be compared with A (40) and the third with CO or N₂ (28) with the highest accuracy. It will be noted that one member of each group is obliterated by the reference line, but not the same one. The singly and doubly charged krypton clusters can be seen to the right and left of Spectrum VIII. It will be noticed that krypton is the first element examined which shows unmistakable isotopes differing by one unit only.

On the krypton plates taken with the greatest magnetic field faint, but unmistakable indications of lines in the region of 130 could just be detected. The richest sample was therefore fractionated over liquid air, and the last fraction, a few cubic millimetres, was just sufficient to produce the xenon lines in an unmistakable manner. These can be seen on Spectrum IX., but are somewhat fuzzy owing to the wide diaphragm used to get maximum intensity. They are apparently five in number and appear to follow the integer rule. Until pure xenon is available no final figures can be given, but the values may be taken provisionally as 128, 130, 131, 133, and 135.

MERCURY (At. Wt. 200.6).

Owing to the presence of mercury vapour (which is generally beneficial to the smooth running of the discharge) the multiply-charged particles of this element appear on nearly all the plates taken. They appear as a series of blurred clusters of decreasing intensity around points corresponding to 200, 100, 66.6, 50 . . . etc., some of which are indicated in the spectra reproduced. It may be stated provisionally that they indicate a strong component 202, a weak one 204, and a strong band from 197 to 200 containing three or four more unresolvable at present.

Table of Results.

Element.	Atomic number.	Atomic weight.	Minimum number of isotopes.	Mass of isotopes in order of intensity.
H	1	1.008	1	1.008
He	2	3.09	1	4
C	6	12.00	1	12
N	7	14.01	1	14
O	8	16.00	1	16
Ne	10	20.20	2	20, 22, (21)
Cl	17	35.46	2	35, 37, (39)
A	18	39.9	(2)	40, (36)
Kr	36	82.92	6	84, 86, 82, 83, 80, 78
X	54	130.2	5	(128, 131, 130, 133, 135)
Hg	80	200.6	(5)	(197-200, 202, 204)

[Numbers in brackets provisional only.]

The Whole-number Rule.

The most important generalization yielded by these experiments is the remarkable fact that (with the exception of H_1 , H_2 , and H_3) all masses atomic or molecular, element or compound, so far measured are whole numbers within the accuracy of experiment. It is naturally premature to state that this relation is true for all elements, but the number and variety of those already exhibiting it makes the probability of this extremely high.

On the other hand, it must not be supposed that this would imply that the whole-number rule holds with mathematical exactness, but only that the approximation is of a higher order than that exhibited by the ordinary chemical combining weights and is quite close enough to allow of a theory of atomic structure far simpler than those put forward in the past; for such theories were forced to attempt the explanation of fractions which now appear to be merely fortuitous statistical effects due to the relative quantities of the isotopic constituents.

Thus one may now suppose that an elementary atom of mass m may be changed to one of mass $m + 1$ by the addition of a positive particle and an electron. If both enter the nucleus an isotope results, for the nuclear charge is unaltered. If the positive particle only enters the nucleus, an element of next higher atomic number is formed. In cases where both forms of addition give a stable configuration, the two elements will be isobares.

The electromagnetic theory of mass asserts that mass is not generally additive but only becomes so when the charges

are relatively distant from each other. This is certainly the case when the molecules H_2 and H_3 are formed from H_1 , so that their masses will be two and three times the mass of H_1 with great exactness. (It must be remembered here that the masses given by these experiments are those of positively charged particles, H_1 being presumably a single particle of positive electricity itself, and that the mass of an electron on the scale used is .00054 and too small to affect the results.)

In the case of helium, the standard oxygen, and all other elements, this is no longer the case; for the nuclei of these are composed of particles and electrons packed exceedingly close together. The mass of these structures will not be exactly the sum of the masses of their constituents but probably less, so that the unit of mass on the scale chosen will be less than that of a single hydrogen atom.

The Heavier Elements.

The results hold out the probability of great complexity in elements of high atomic number, which has already been proved by entirely different methods in the case of lead. The present apparatus has a resolution factor too low to deal adequately with these; so attention is being given to elements within its scope and to which the analysis can be applied. Results are steadily accumulating, which will be published in due course.

In conclusion the author wishes to express his indebtedness to the Government Grant Committee of the Royal Society for defraying the cost of some of the apparatus employed.

Summary.

A positive ray spectrograph capable of giving a focussed mass-spectrum is fully described in detail and its technique explained.

The results of a provisional analysis of eleven chemical elements—H, He, C, N, O, Ne, Cl, A, Kr, X, Hg—are given, showing that of these the first five only are "pure," the others being apparently composed of various numbers of isotopic constituents, krypton containing no less than six.

With the exception of those due to H_1 , H_2 , and H_3 , all masses measured, allowing for multiple charges, are exactly whole numbers within the error of experiment ($O=16$).

The lines due to hydrogen indicate that the mass of the atom of this element is greater than unity on this scale and in good agreement with the chemical value 1.008. Reasons for this are suggested.

Cavendish Laboratory,
March 1920.

LX. *On the Advance of the Perihelion of a Planet, and the Path of a Ray of Light in the Gravitation Field of the Sun.*
By Prof. A. ANDERSON*.

THE particular integral of Einstein's contracted tensor equations, which has been applied to the case of the motion of a planet in the sun's gravitational field is

$$ds^2 = -\gamma^{-1}dr^2 - r^2d\theta^2 + \gamma dt^2,$$

neglecting the term in ϕ , as the motion may be considered to take place in the plane $\phi=0$. The quantity denoted by γ is $1-2m/r$, where m is a constant. A contravariant vector is found that is suitable for the motion of a planet, and then it appears that

$$v^2 = \frac{2m}{r} - \frac{m}{a} + \frac{2mh^2}{r^3},$$

where a is a constant and $h=vp$.

Thus m is identified with the astronomical mass of the sun, and a with the semi-axis major of the planet's orbit. The term $\frac{2mh^2}{r^3}$ indicates an advance of the perihelion of the planet through an angle $\frac{6\pi m^2}{h^2}$ in every revolution. The advance of the perihelion of Mercury ($43''$ per century) is accounted for.

In the case of the path of a ray of light $ds=0$, and we get, using the same particular integral,

$$\left(\frac{dr}{dt}\right)^2 + \gamma r^2 \left(\frac{d\theta}{dt}\right)^2 = \gamma^2,$$

but this equation is unsuitable. We want an equation which will give us the velocity of light as a function of r . That is, we want an equation of the form

$$\left(\frac{dr}{dt}\right)^2 + r^2 \left(\frac{d\theta}{dt}\right)^2 = \text{some function of } r.$$

Now it appears that we may take any function of r instead of r and then call this function r . So that we must get a function of r that, when substituted for r , will give us an equation of the necessary form. If we make $r=f(r_1)$, it is easily proved that we must have

$$r_1^2 = f'(r_1)^2 \left(1 - \frac{2m}{f(r_1)}\right) / f''(r_1)^2,$$

* Communicated by the Author.

and we get, remembering that $r_1 = r$ when $m = 0$,

$$4r_1 = (r^{\frac{1}{2}} + (r - 2m)^{\frac{1}{2}})^2,$$

which gives $r = (2r_1 + m)^2 / 4r_1$.

Writing r for r_1 , we now get

$$\text{velocity of light} = \left(1 - \frac{m}{2r}\right) / \left(1 + \frac{m}{2r}\right)^3,$$

or

$$\text{the index of refraction } \mu = \left(1 + \frac{m}{2r}\right)^3 / \left(1 - \frac{m}{2r}\right).$$

The p and r equation of the path of a ray of light is consequently

$$p \left(1 + \frac{m}{2r}\right)^3 / \left(1 - \frac{m}{2r}\right) = a \left(1 + \frac{m}{2a}\right)^3 / \left(1 - \frac{m}{2a}\right) = c,$$

where a is the distance of the sun's centre from the apse, and m is assumed to have the same meaning as before.

If squares of $\frac{m}{r}$ are neglected, $\mu = 1 + \frac{2m}{r}$, and the equation of the path is

$$p \left(1 + \frac{2m}{r}\right) = a + 2m.$$

We may remark, though perhaps the assumption is very violent, that if the mass of the sun were concentrated in a sphere of diameter 1.47 kilometres, the index of refraction near it would become infinitely great, and we should have a very powerful condensing lens, too powerful indeed, for the light emitted by the sun itself would have no velocity at its surface. Thus if, in accordance with the suggestion of Helmholtz, the body of the sun should go on contracting, there will come a time when it will be shrouded in darkness, not because it has no light to emit, but because its gravitational field will become impermeable to light.

Taking the p and r equation of the path of a ray of light we find that the angle between its asymptotes is $\frac{2c\theta}{\kappa}$, where

$$\sin \theta = \frac{2m(\kappa^2 - 2ma) - \kappa(a^2\kappa^2 + 4ma\kappa^2 - \kappa^4)^{\frac{1}{2}}}{a(4m^2 + \kappa^2)},$$

$$c = a \left(1 + \frac{m}{2a}\right)^3 / \left(1 - \frac{m}{2a}\right),$$

and $\kappa^2 = c^2 - 4m^2$. If we neglect squares of m , this becomes

$$2 \sin^{-1} \frac{2m}{a} \quad \text{or} \quad \frac{4m}{a}.$$

In obtaining the path of a ray of light, we have changed r in the original particular integral to $(2r+m)^2/4r$, and it must be legitimate to go back to the case of the planet and make the same change. We thus get

$$\left(\frac{dr}{ds}\right)^2 + r^2\left(\frac{d\theta}{ds}\right)^2 = c^2 \left/ \left(1 - \frac{m^2}{4r^2}\right)^2 - \left(1 - \frac{m}{2r}\right)^2 \right/ \left(1 + \frac{m}{2r}\right)^2,$$

where c is a constant, and

$$\frac{(2r+m)^4}{16r^2} \cdot \frac{d\theta}{ds} = h, \text{ a constant.}$$

Neglecting squares of m , these equations become

$$\left(\frac{dr}{ds}\right)^2 + r^2\left(\frac{d\theta}{ds}\right)^2 = c^2 - 1 + \frac{2m}{r},$$

and

$$r^2\left(1 + \frac{2m}{r}\right)\frac{d\theta}{ds} = h.$$

It is clear that $c^2 - 1 = -\frac{m}{a}$, and dividing the first equation by the square of the second, we get, neglecting squares of m ,

$$\left(\frac{du}{d\theta}\right)^2 + u^2 = -\frac{m}{ah^2} + \frac{2mu}{h^2},$$

or

$$\frac{d^2u}{d\theta^2} + u = \frac{m}{h^2}, \text{ where } u = \frac{1}{r},$$

the ordinary Newtonian equation for elliptic motion. So that Mercury, unfortunately, is left with the advance of his perihelion unexplained. But his rate of description of areas is not constant; it is least at perihelion and greatest at aphelion.

The astronomical unit of mass used in the above is 9×10^{25} times the ordinary astronomical unit of mass; the unit of length is the kilometre, and the unit of time the time required for light to travel one kilometre in a forceless field.

University College, Galway,
13th February, 1920.

LXI. *Notices respecting New Books.*

An Enquiry concerning the Principles of Natural Knowledge. By A. N. WHITEHEAD, Sc.D., F.R.S. Cambridge: The University Press, 1919.

PROFESSOR WHITEHEAD'S book has made its appearance at a very fortunate moment. He could not have anticipated that a few months after its publication the verification of a prediction in regard to an astronomical event would be astonishing the intellectual world and setting everyone trying to understand the revolution it implies in our fundamental concept of Nature. It is this fundamental concept and the principles on which we must, in view of recent developments of science, in future base our physics, which are investigated in this most fascinating Enquiry.

Professor Whitehead's mathematical followers will no doubt complain that so large a part of the book deals with metaphysics; his philosopher friends, on the other hand, may be appalled at the intricate mathematical maze into which they will seem to be unheedingly conducted. The conception that physics and metaphysics are one identical problem is, however, the dominating thought in science and philosophy to-day, and it finds clear expression in this book.

The main thesis can be briefly stated. It is that the traditional concept which has hitherto subtended the structure of physical science, the concept of all nature at a durationless instant, is no longer possible. The simple attempt to realize it in thought makes everything that is anything in science meaningless. There is no alternative in science but to abandon it, and replace it with a new fundamental concept of which duration is the essence. Nature does not consist of facts, that is, of material space-occupancy at definite moments of time, but of events. Nothing which is not event has any place whatever within the reality of nature. This has been clear from the first in biology but it has waited long for recognition in physics, and indeed all the attempts to base biology on physics have been conceived with the idea that the reality of physics is fundamentally different and more elemental. The theory of the electro-magnetic origin of mass has revolutionized the metaphysics of physics. "The modern theory of the molecule is destructive of the obviousness of the prejudgment in favour of the traditional concepts of ultimate material at an instant. Consider a molecule of iron. It is composed of a central core of positive electricity surrounded by annular clusters of electrons, composed of negative electricity and rotating round the core. No single characteristic property of iron as such can be manifested at an instant. . . . Iron and a biological organism are on a level in requiring time for functioning. There is no such thing as iron at an instant; to be iron is a character of an event." (5. 4.)

It is curious to those of us who are old enough to remember the generation of the great Victorian men of science, to reflect on

the nature of the confidence which inspired them, and compare it with the present development of science and the quite different kind of confidence which inspires our men of science to-day. I am thinking of the feelings with which that generation heard the British Association Addresses of Tyndall, Huxley, and Clifford, to take three leading names. There was in all they said a note of clear triumph, they proclaimed a victory achieved, all that remained to do was to reap the fruits. Beneath this confidence and its basis was the belief that Nature is extremely simple in its framework and universal laws, magnificent in its perspective, stupendous in its grandeur, but at bottom an arrangement of space and time and material in a vast chemical laboratory functioning automatically.

It was too simple. The task of science has turned out very differently. New and unsuspected realms of reality have been disclosed, ever-growing complexities have destroyed the simplicity of the first generalizations. Men of science to-day have not lost confidence in science but the basis of that confidence is shifted. Nature does not present itself to us as self-revealing, as a school-master from whom like children we have obediently to learn.

The first thing on which Professor Whitehead insists in this Enquiry is the impossibility of any pure science of Nature which begins by ignoring the problem of the relation of the mind to its objects. We have to take into account that we perceive, and that the immediate objects of the mind are its perceptions. Physical science has been impatient of Berkeley's problem, and has turned it over to speculative philosophy as a problem science can dispense with. To-day we are realizing more and more clearly that this cannot be ignored without fatal consequences to science itself. The new principle of relativity is, in effect, the inclusion of the problem of perception in physical science itself.

The Enquiry is divided into four parts. In Part I. Professor Whitehead criticizes the traditional concepts and shows how they have failed by reason of that very aloofness from the philosophical problem which has been their boast. The problem of movement then leads him to describe Newton's laws of motion, Clerk Maxwell's equations, and Einstein's scientific relativity. Part II. deals with the data of science, and here we have the exposition of the root concept which Professor Whitehead proposes for the new organization of science, the event. Now, because an event seems analysable into factors and because these factors seem separable as well as distinguishable, it has always been taken to be composite, a synthesis of the factors into which it is analysed. Science therefore has always sought to go behind the event to what have seemed to be its constituent elements, for its data. But the factors of an event are not isolable, and consequently there are no simple elements which constitute by their conjunction the event. In Part III. Professor Whitehead expounds his method. This part is, as we should expect, severely mathematical. Taking events as his data he shows how they must be coordinated to yield a

science of Nature. Instead of the traditional space, time, and material, we have now to deal with "durations" which we are asked to conceive as temporal thicknesses or slabs of nature, and we are taken through the whole range of transformations which the new concept requires. In Part IV. we have the theory of objects. It is a most important section. For though we may hold with the idealist philosophers that there are no things, we cannot have physical science and no objects. How, then, do events take on the character of objects? The theory gives the answer. In his final chapter, entitled "Rhythms," Professor Whitehead shows how deeply he is in sympathy with the philosophers who, like Bergson, approach the great problem of the ultimate nature of physical reality from the side of spirit rather than from the side of matter.

It will be seen then that this book is simply invaluable to anyone who wishes to bring himself into line with the new principle of relativity, whether his interest be scientific in the narrow sense or philosophical in the wide sense.

John Stuart Mill tells us in his *Autobiography* that he was at times actually depressed by the thought that musical chords though practically infinite in the number of combinations they admitted were yet in reality finite and exhaustible. Our feeling as we close Professor Whitehead's book is one almost of elation at the thought of how little we know, and how uncertain is the little we think we know, when we form our concepts of the framework of infinite Nature.

Manual of Meteorology. Part IV.: *The Relation of the Wind to the Distribution of Barometric Pressure.* By Sir NAPIER SHAW, Sc.D., F.R.S. [Pp. xvi+166, with 3 plates.] Cambridge: At the University Press, 1919. Price 12s. 6d. net.

THE other Parts of the manual of which the volume under review forms Part IV. have not yet been published. The appearance of the last Part in advance, though it may at first appear strange, is due to excellent reasons. Whilst the subject-matter which will form the first three Parts of the manual is available to the student of meteorology in various sources of reference, the present volume represents mainly the progress made by those who have been associated with the work of the Meteorological Office during the past twenty years. The subject-matter was not, therefore, previously available in collected form. The author has, in fact, incorporated the results of several quite recent researches. Students of meteorology are indebted to him, not only for having collected together the subject-matter, the greater part of which has hitherto only been available in the scattered original publications, but also for having combined it into a homogeneous whole and, in doing so, setting out what is practically a general meteorological theory.

As a working hypothesis, with which to test the complicated

and often apparently contradictory results of observation, the author assumes that the motion of the air is at right angles to the direction of the pressure gradient and has the velocity deduced from the gradient equation. The latter equation is derived by assuming that the motion is under balanced forces depending on the spin of the Earth and the spin in a small circle on the Earth. This leads to a study of the relationship between the surface-wind and the geostrophic wind at sea-level and of the variation of wind with height. A summary is given of Taylor's theory of the diffusion of eddy-motion, and comparisons are made between the results calculated from it and those provided from observations of pilot-balloons. The detailed discussion of the geometry and mechanics of a travelling cyclone is very suggestive, and the distinction drawn by the author between the instantaneous kinematic centre, the tornado centre, and the dynamic curve as shown by the isobars is an important one. A summary is given of Rayleigh's exposition of the properties of a stationary column of revolving fluid, and Aitken's experimental illustrations of the dynamics of cyclones are critically discussed. Lord Rayleigh's discussion neglected the effect of the rotation of the Earth, and it is somewhat surprising that the results agree as well as they do with observation. The reproduction of instrumental records relative to several notable storms and their discussion help to give a clear idea as to the extent to which theory and observation agree.

The volume is an important contribution to meteorological literature. We hope that the other Parts will be published at an early date.

H. S. J.

Stereochemistry. By ALFRED W. STEWART, D.Sc., Professor of Chemistry in the Queen's University of Belfast. Second Edition. Pp. xvi + 277. [Text Books of Physical Chemistry.] London: Longmans, Green & Co., 1919.

THE chief alterations in this second edition are the following: Recognition is made of the existence of optically active compounds containing no carbon atom, the activity of aniline oxides, and corresponding phosphorus derivatives, and of the preparation of allylene analogues in active forms.

The Walden inversion phenomena are given the place for which they are worthy. On the other hand, we are glad to see that the space previously devoted to steric hindrance has been cut down. That branch of the subject seemed likely to spread as an obsession over the whole subject—to its detriment.

A short chapter is devoted to the arrangement of atoms in crystals, in which the work of the Braggs (father and son) is outlined. It would have been well, however, if the author had submitted this chapter for revision to a friend competent to express an opinion on the subject.

THE
LONDON, EDINBURGH, AND DUBLIN
PHILOSOPHICAL MAGAZINE
AND
JOURNAL OF SCIENCE.

[SIXTH SERIES.]

JUNE 1920.

LXII. *The Specific Heat of Saturated Vapour and the Entropy-Temperature Diagrams of certain Fluids.* By Sir J. A. EWING, K.C.B., F.R.S.*

THE "specific heat of saturated vapour," is a thermodynamic quantity whose interest is mainly historical, for the phenomena associated with it are now usually stated in other ways. But it has given rise to a misconception which is still reflected in authoritative text-books. This is readily avoided if the subject be considered with reference to a type of diagram, familiar to engineers, in which the entropy of the saturated vapour is exhibited in relation to the temperature.

Following Rankine, by whom the phrase was first used †, we shall represent the specific heat of a saturated vapour by K_s . It means the quantity of heat required, per unit of mass, to increase the temperature by one degree, while the pressure and the volume are so altered that a state of saturation is maintained. In steam, as is now well known, K_s is a negative quantity. It is also well known that when K_s is negative a vapour becomes supersaturated or partially condensed when it suffers adiabatic expansion, and becomes superheated when it suffers adiabatic compression; conversely, when K_s is positive a vapour is superheated by

* Communicated by the Author.

† In a paper read before the Royal Society of Edinburgh, Feb. '4, 1850, Trans. R. S. E. vol. xx., or Miscellaneous Scientific Papers, p. 259.

adiabatic expansion and is supersaturated or partially condensed by adiabatic compression. The fact that K_s is negative in steam was pointed out independently and almost simultaneously by Rankine (in the paper cited) and by Clausius*, who also showed that in any fluid

$$K_s = K_w + \frac{dL}{dT} - \frac{L}{T},$$

where L is the latent heat and K_w is the specific heat of the liquid (at the same temperature) when heated under saturation pressure. Later, when Regnault's data for various fluids became available, Clausius applied this relation to them, finding K_s to be negative in most cases. In ether, however, he found that Regnault's data made K_s positive "at least at ordinary temperatures," and in other fluids the value of K_s calculated from them increased as the temperature rose (that is to say, its negative value decreased). He continues: "In the only case, that of ether, in which it is positive at ordinary temperatures its absolute value increases as the temperature rises. In the other cases, in which it is negative, its absolute value diminishes; *it thus approaches zero, and it would appear that at some higher temperature it would attain the value zero and at still higher temperatures would become positive*" †. I have italicised this passage because, although the statement is true of certain fluids, there are many for which it is not true. Other well-known writers have made the same suggestion, that in water and in fluids generally, the specific heat of the saturated vapour changes sign from negative to positive when the temperature is sufficiently raised ‡. From the form of the entropy-temperature diagram, however, it is clear that this does not happen in steam, nor in any of the fluids commonly used as working substances in refrigerating machines (carbon dioxide, ammonia, sulphurous acid), nor in bisulphide of carbon, nor (as will presently be seen) in alcohol. On the other hand, it does happen in a considerable number of other fluids, such as ether, chloroform, benzene, and many esters of the fatty acids, for which the researches of Ramsay and Young and

* In a paper communicated to the Academy of Berlin, Feb. 1850, *Pogg. Ann.* vol. lxxix. p. 368 and p. 500; *Phil. Mag.* July 1851. See his 'Mechanical Theory of Heat' (Tr. Browne), p. 135.

† Clausius, 'Mechanical Theory of Heat' (Tr. Browne), p. 139.

‡ Cf. Preston, 'Theory of Heat,' 3rd ed. p. 731; Peabody, 'Thermodynamics of the Steam-Engine,' 5th ed. p. 94; Lewis, 'Physical Chemistry,' 2nd ed. vol. ii. pp. 83-85; L. Natanson, *Phil. Mag.* Oct. 1895, p. 277; C. Raveau, *Jour. de Phys.* (3) vol. i. p. 461 (1892).

others have supplied data by help of which one may draw a first approximation to the entropy-temperature diagram.

From that diagram it is easy, by inspection, to see how the sign and magnitude of K_s are affected by changes of temperature. The diagram exhibits the entropy of the liquid, ϕ_w , at saturation pressure, and also the entropy of the saturated vapour, ϕ_s , in relation to the temperature, by means of a continuous curve whose summit is at the critical point. The outer limb of this curve, from the critical point onward, is the saturation line, relating to saturated vapour, and is the part with which we are immediately concerned. Let the state of the substance change by a small step along the saturation line, with the result that the entropy changes by $d\phi_s$ and the temperature by dT . The heat taken in is $K_s dT$, by definition of K_s . It is also equal to $T d\phi_s$, since the step is reversible. Hence

$$K_s = T \frac{d\phi_s}{dT}$$

and is negative under all conditions that make the entropy of the vapour increase with decreasing temperature. In other words, it is negative so long as the entropy-temperature line for saturated vapour slopes down to the right, as in fig. 1 or fig. 2. This is what may be called the normal form of the curve, such as is found in steam, carbon dioxide, or ammonia.

To make K_s positive would require that a part of the line for saturated vapour should slope the other way, as in fig. 3, where positive values of K_s would be found at any temperature between A and B, with negative values at any temperature above A or below B. The point B corresponds to the reversal of the sign of K_s which was, in certain substances, predicted from Regnault's data and verified by the experiments of Hirn * and Cazin † on the effects of adiabatic expansion and compression.

It is obvious that, however strongly positive K_s may be at an intermediate temperature, it necessarily becomes negative, in all substances, as the critical point is approached; for the saturation line must then bend over to the left to become continuous with the liquid line which forms the other limb of the diagram. At the critical point the value of K_s is $-\infty$.

In any fluid the entropy increases during vaporization at constant temperature by the amount L/T . Thus

$$\phi_s = \phi_w + \frac{L}{T}$$

* Hirn, *Cosmos*, vol. xxii. p. 413 (1863).

† Cazin, *Ann. de Chim. et de Phys.* (4) vol. xiv. p. 374 (1868).

On differentiating this with respect to T , and multiplying by T , the Clausius equation quoted above is at once obtained:—

$$T \frac{d\phi_s}{dT} = T \frac{d\phi_w}{dT} + \frac{dL}{dT} - \frac{L}{T},$$

$$\text{or } K_s = K_w + \frac{dL}{dT} - \frac{L}{T}.$$

But when it is practicable to draw the entropy diagram the changes of K_s are made evident without recourse to this equation.

To draw the entropy diagram one may proceed by first calculating ϕ_w and then adding L/T to find ϕ_s . According to the usual convention ϕ_w is taken as zero when the temperature is 0°C . Then at any scale-temperature t , (or $T - 273^\circ \cdot 1$)

$$\phi_w = \int_0^t \frac{C_p dT}{T},$$

where C_p is the specific heat of the liquid at constant pressure, namely the pressure of saturation for the given temperature. When an empirical formula connecting C_p with the temperature is available, this allows ϕ_w to be readily calculated. The values so found cannot be regarded as more than approximate at temperatures beyond the experimental range from which the formula for C_p has been deduced, and in general that range is rather narrow. But the method gives a first approximation to the entropy-temperature diagram, which at least suffices to distinguish what may be called normal cases, such as are represented by fig. 1, from others which clearly resemble fig. 3. In these last there are unquestionable reversals of the sign of K_s .

I have drawn the diagrams in this way for a number of fluids, using in most instances the values of L given by Young in his paper on the vapour-pressures and heats of vaporization of thirty pure substances*, along with such data for C_p as I have been able to find. The following are representative examples.

Alcohol.—From the experiments of Bose †, C_p for ethyl alcohol is taken as

$$0.5396 + 0.001698 t,$$

from which

$$\phi_w = 0.1747 \log_{10} T + 0.001698 T - 0.8892.$$

* S. Young, Scientific Proceedings of the Royal Dublin Society, vol. xii. p. 374 (1910).

† Bose, *Gött. Nachr.* 1906, p. 278; *Zeit. für phys. Chem.* vol. lvi. p. 585 (1907).

Values of L/T are got from Ramsay and Young's values of L^* . With these data the following numbers have been obtained for the entropy of the liquid and of the saturated vapour, and the curve of fig. 1 has been drawn.

Ethyl Alcohol.

Temp.	Entropy of the liquid. ϕ_w	$\frac{L}{T}$	Entropy of the vapour. ϕ_s
0°	0	0.8089	0.8089
20	0.0394	0.7528	0.7922
40	0.0785	0.6985	0.7770
60	0.1171	0.6406	0.7577
80	0.1555	0.5845	0.7400
100	0.1936	0.5283	0.7219
120	0.2315	0.4686	0.7001
140	0.2692	0.4142	0.6834
160	0.3068	0.3623	0.6691
180	0.3442	0.3072	0.6514
200	0.3814	0.2465	0.6279
220	0.4185	0.1789	0.5974
240	...	0.0785	...
l (critical)	...	0	0.51 (about)

Fig. 1.—Ethyl Alcohol.

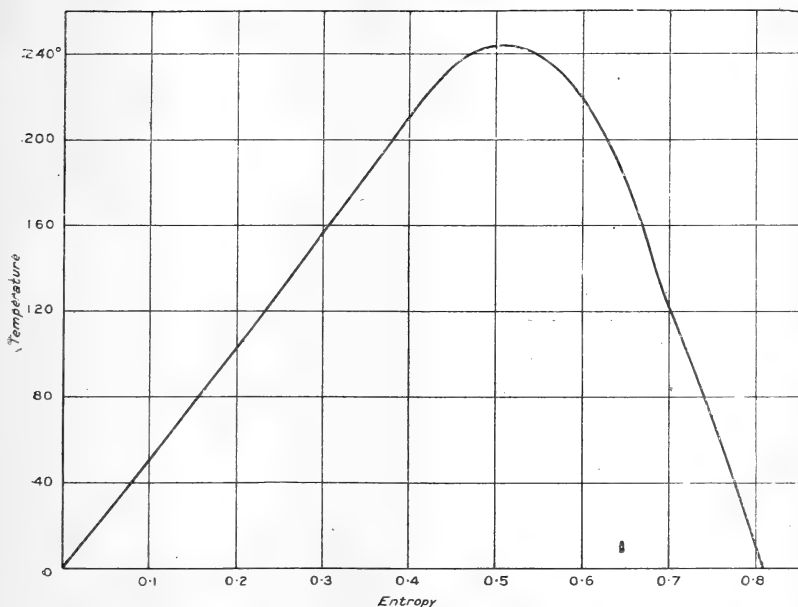

* Phil. Trans. 1886, pt. 1, p. 153.

From 0° to 180° the saturation line is nearly straight, with a slight bend about 120° which may be due to irregularities in the determination of L . The entropy diagram for ethyl alcohol is clearly of the "normal" type, showing negative values for the specific heat of the saturated vapour throughout the whole range of temperature.

This is also true of methyl alcohol, which has a diagram of the same type, but with a wider spread of the two limbs, on account of its possessing greater latent heat.

The diagram for propyl alcohol is shown in fig. 2. It is calculated in the same way from Ramsay and Young's values of L , using Bose's formula for the specific heat of the liquid, namely,

$$0.5279 + 0.001692 t,$$

from which

$$\phi_w = 0.1515 \log_{10} T + 0.001692 T - 0.8312.$$

The resulting numbers are given below.

Propyl Alcohol.

Temp.	ϕ_w .	L/T .	ϕ_s .
40°	0.0767
80	0.1523	0.4899	0.6422
100	0.1898	0.4395	0.6293
120	0.2270	0.3892	0.6162
140	0.2642	0.3447	0.6089
160	0.3011	0.2979	0.5990
180	0.3379	0.2567	0.5946
200	0.3746	0.2160	0.5906
220	0.4111	0.1730	0.5841
240	0.4476	0.1286	0.5712
263.7 (critical)	...	0	0.52 (about)

Here again the figure is of the "normal" type, but there is a distinct bend in the saturation line which, though insufficient to make the specific heat of the saturated vapour positive at any temperature, tends that way.

Ether.—Turn now to a substance in which the specific heat of the saturated vapour is known to be positive at some temperatures, namely ethyl ether. I have used Ramsay and Young's values of L , along with Regnault's formula for the specific heat of the liquid*, namely,

$$0.529 + 0.0005917 t,$$

* Regnault, *Relation des Expériences*, vol. ii. p. 175.

Fig. 2.—Propyl Alcohol.

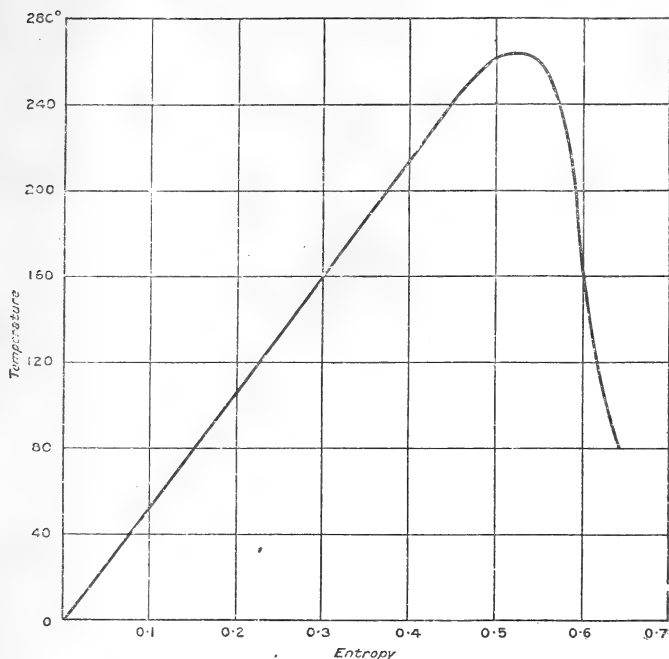

from which

$$\phi_w = 0.8459 \log_{10} T + 0.0005917 T - 2.2226.$$

The results are shown below and in fig. 3.

Ethyl Ether.

Temp.	ϕ_w	L. T.	ϕ_s
0	0	0.3388	0.3388
20	0.0377	0.2987	0.3364
40	0.0738	0.2645	0.3383
60	0.1084	0.2355	0.3439
80	0.1416	0.2082	0.3498
100	0.1737	0.1834	0.3571
120	0.2047	0.1583	0.3630
140	0.2348	0.1339	0.3687
160	0.2640	0.1064	0.3704
180	0.2924	0.0703	0.3607
193.8 (critical)	0	0.33 (about)

Here for the greater part of its course, from about 20° to 150° or thereabouts, the saturation line slopes up to the right, showing that within these limits the specific heat of

Fig. 3.—Ether.

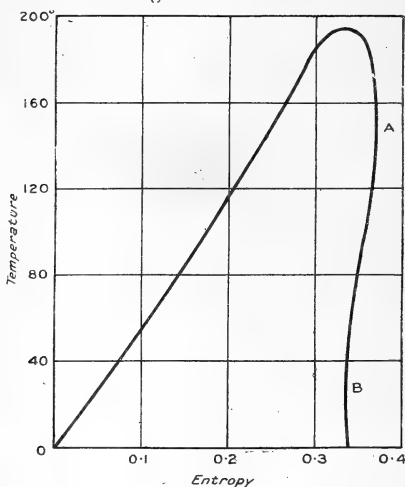

the saturated vapour is positive. Below 20° it is negative, and it of course becomes negative again as the critical point is approached.

Another substance which gives a diagram of the same type is *Benzene* (fig. 4). In drawing the diagram for *Benzene* I have taken Schiff's formula for the specific heat of the liquid, namely *,

$$0.3834 + 0.001043 t,$$

from which

$$\phi_w = 0.2270 \log_{10} T + 0.001043 T - 0.8380.$$

Young's values of L are used †, but as they do not extend below 70° I have determined L for 0°, 20°, 40°, and 60° by taking Regnault's values of the total heat of formation of the vapour (under constant pressure, from liquid at 0° C.)

and deducting from that the quantity $\int_0^t C_p dt$, which represents the heat required to warm the liquid up to the temperature of vaporization. The values of L below 70° so determined fit in pretty smoothly with those found by

* R. Schiff, *Liebig's Annalen*, vol. 234. p. 319.

† S. Young, *loc. cit.* p. 422.

Young at higher temperatures. In the table that follows they are distinguished by square brackets.

Fig. 4. — Benzene.

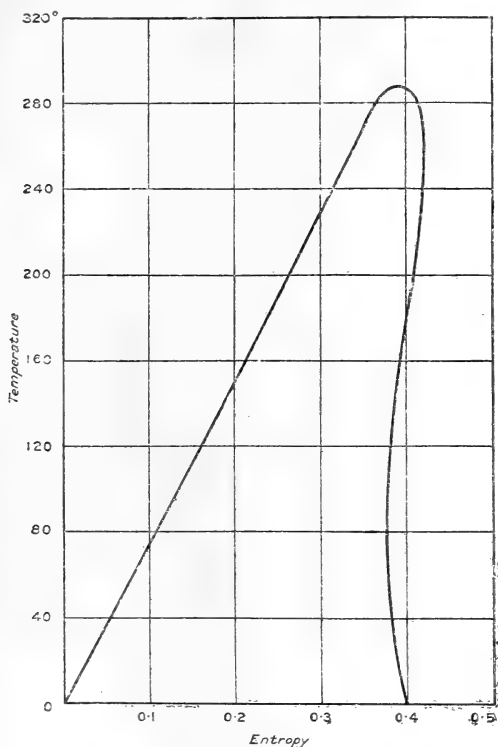

Benzene.

Temp.	ϕ_w	L.	L/T.	ϕ_s
0°	0	[109.0]	0.3991	0.3991
20	0.0278	[106.0]	0.3616	0.3894
40	0.0552	[102.4]	0.3271	0.3823
60	0.0821	[98.3]	0.2951	0.3772
80	0.1088	95.45	0.2703	0.3791
100	0.1350	91.41	0.2450	0.3800
120	0.1610	86.58	0.2203	0.3813
140	0.1869	82.32	0.2005	0.3874
160	0.2123	78.94	0.1823	0.3946
180	0.2377	74.62	0.1647	0.4024
200	0.2628	68.81	0.1454	0.4082
220	0.2877	62.24	0.1262	0.4139
240	0.3125	54.11	0.1055	0.4180
260	0.3371	43.82	0.0822	0.4193
280	0.3616	27.43	0.0496	0.4112
288.5 (critical)		0	0	0.39 (about)

The curve (fig. 4) changes the sign of its slope at about 80° , but the position of the minimum of ϕ_s is not well defined. Cazin*, using large amounts of sudden compression and sudden expansion, found that a mist was produced in benzene vapour by expansion at temperatures below 115° and by compression at temperatures above 130° . He places the point of inversion in the neighbourhood of 120° . The entropy diagram shows clearly that the specific heat of the saturated vapour of benzene is positive throughout a considerable range of temperature.

In the paper cited, Young gives values of L for ten esters of the fatty acids. Of these esters seven are included among the substances whose specific heat, in the liquid state, has been investigated by Schiff, namely, methyl and ethyl propionate, ethyl and propyl acetate, propyl formate, methyl butyrate, and methyl isobutyrate. From his measurements of specific heats in these seven esters (and many more) Schiff has concluded that their specific heat is expressed by the formula †

$$0.4416 + 0.00088 t,$$

which would make, for all of them,

$$\phi_w = 0.4635 \log_{10} T + 0.00088 T - 1.3696.$$

Using this formula along with the values of L given by Young, I have calculated ϕ_w and ϕ_s and have drawn an entropy-temperature diagram for each of these substances. The values so obtained are given in the table below, and one example of the diagrams is reproduced in fig. 5, namely the diagram for ethyl propionate, which in its general character is representative of the others. It closely resembles the diagram for benzene, and indicates a point of inversion somewhere about 40° C. The table shows that all these esters belong to the class of fluids in which the specific heat of the saturated vapour is positive throughout a certain range of temperature.

* *Loc. cit.* p. 396.

† R. Schiff, *loc. cit.* p. 340.

Esters of the Fatty Acids.

Temperature.	Entropy of the Liquid, ϕ_w .	Entropy of the Saturated Vapour, ϕ_s .						
		Methyl Propionate.	Ethyl Propionate.	Ethyl Acetate.	Propyl Acetate.	Propyl Formate.	Methyl Butyrate.	Methyl Isobutyrate.
0°	0	...	0.3571
20	0.0318
40	0.0627
60	0.0927
70	0.1075	0.3667	...	0.3623	...	0.3670
80	0.1221	0.3687	...	0.3650	...	0.3699
90	0.1366	0.3712	0.3583	0.3681	0.3615	0.3706	...	0.3468
100	0.1508	0.3726	0.3632	0.3710	0.3647	0.3723	0.3593	0.3512
120	0.1789	0.3780	0.3701	0.3757	0.3731	0.3777	0.3679	0.3586
140	0.2065	0.3842	0.3764	0.3814	0.3780	0.3850	0.3780	0.3682
160	0.2336	0.3910	0.3840	0.3858	0.3808	0.3913	0.3872	0.3770
180	0.2603	0.3972	0.3926	0.3924	0.3889	0.3971	0.3971	0.3865
200	0.2866	0.4043	0.4021	0.3980	0.4076	0.4069	0.4079	0.3966
220	0.3125	0.4081	0.4109	0.3990	0.4155	0.4131	0.4166	0.4041
240	0.3381	0.4052	0.4165	0.3911	0.4207	0.4150	0.4241	0.4084
260	0.3634	...	0.4156	...	0.4210	0.4028	0.4280	0.4113
Critical Temperature...	557°·4	972°·9	250°·1	276°·2	264°·8	281°·3	267°·5	

Fig. 5.—Ethyl Propionate.

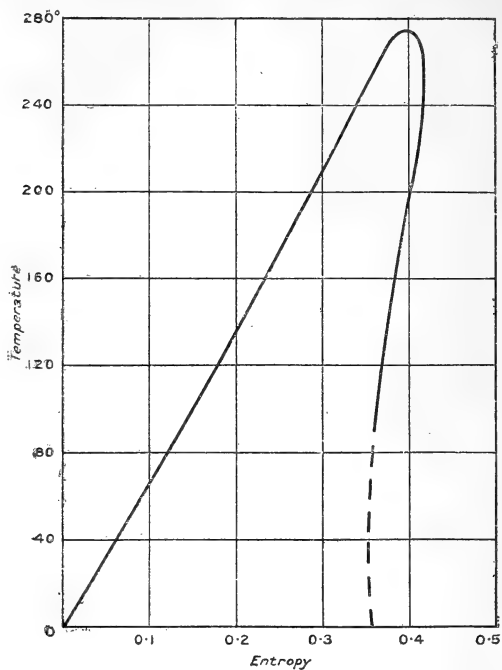

Two other substances in Young's list present points of interest. His values of L for *Carbon Tetrachloride* extend from 70° up to the critical point. Below that we have Regnault's measurements of the total heat of formation, from which L is readily found as in the case of benzene. For the specific heat we have Regnault's formula *

$$0.1980 + 0.0001812 t,$$

from which

$$\phi_w = 0.3419 \log_{10} T + 0.0001812 T - 0.8826.$$

Combining these data we obtain :—

* *Relation des Expériences*, vol. ii. p. 282.

Carbon Tetrachloride.

Temp.	ϕ_w	L/T.	ϕ_s
0°	0	0.1904	0.1904
20	0.0141	0.1736	0.1877
40	0.0275	0.1582	0.1857
60	0.0403	0.1440	0.1843
80	0.0525	0.1306	0.1831
100	0.0643	0.1185	0.1828
120	0.0757	0.1070	0.1827
140	0.0867	0.0966	0.1838
160	0.0974	0.0876	0.1850
180	0.1078	0.0781	0.1859
200	0.1178	0.0689	0.1867
220	0.1276	0.0597	0.1873
240	0.1371	0.0498	0.1869
260	0.1464	0.0376	0.1840
283.1 (critical)	0	0.17 (about)

The figures therefore indicate the existence of a very slight double bend of the fig. 3 type; but the most note-

Fig. 6.—Acetic Acid.

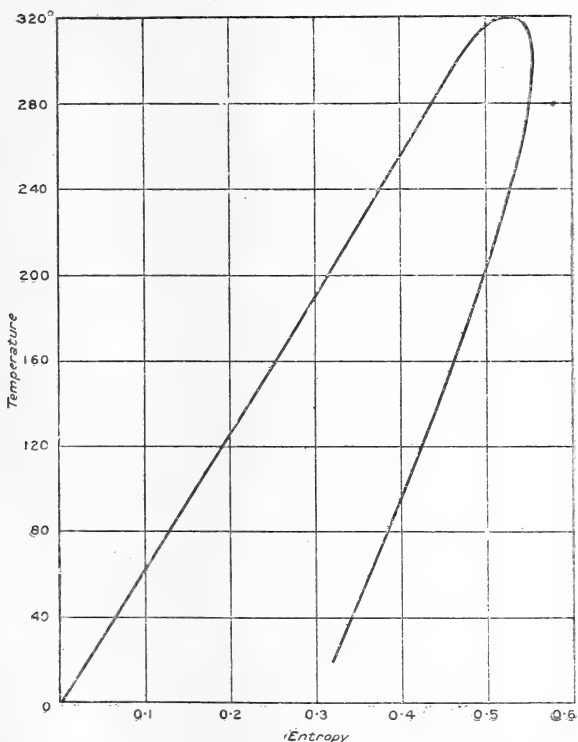

worthy feature is that the entropy of the saturated vapour is nearly constant except close to the critical point.

Lastly, there is *Acetic Acid*, which gives the remarkable diagram shown in fig. 6. This is obtained by the use of Ramsay and Young's values* of L , along with Schiff's formula † according to which the specific heat of the liquid is

$$0.4440 + 0.001418 t,$$

making

$$\phi_w = 0.1306 \log_{10} T + 0.001418 T - 0.7054.$$

The following are the calculated numbers for ϕ_w and ϕ_s . They show that in acetic acid the specific heat of the saturated vapour has an exceptionally high positive value, which it retains even at the lowest temperature to which the observations extend, namely 20° C. The slope of the curve there gives no promise of changing its sign at a lower temperature.

Acetic Acid.

Temp.	ϕ_w	L/T .	ϕ_s
0°	0
20	0.0323	0.2868	0.3191
40	0.0643	0.2779	0.3422
60	0.0963	0.2693	0.3656
80	0.1280	0.2594	0.3874
100	0.1595	0.2474	0.4069
120	0.1908	0.2401	0.4309
140	0.2220	0.2223	0.4443
160	0.2530	0.2069	0.4599
180	0.2839	0.1936	0.4775
200	0.3147	0.1808	0.4955
220	0.3454	0.1663	0.5117
240	0.3760	0.1524	0.5284
260	0.4065	0.1355	0.5420
280	0.4370	0.1148	0.5518
300	0.4674	0.0854	0.5528
321.6 (critical)	...	0	0.53 (about)

* Young, *loc. cit.* p. 443.

† Schiff, *loc. cit.* p. 322.

LXIII. *The Crystalline Structure of Zinc Oxide.* By
 W. LAWRENCE BRAGG, M.A., *Langworthy Professor of
 Physics, Manchester University*.*

ZINC oxide crystallizes in the hexagonal system. The crystals are of the dibhexagonal polar type, with an axial ratio $a:c=1:1.608$. Natural crystals of zinc oxide, or zincite, are rare, and the material used for this investigation consisted of a platy mass of zincite of irregular shape. The direction of the cleavage and etching of the surface showed that the mass was composed of crystals which were very nearly parallel in their orientation. By noting the direction of the facets produced by etching it was possible to grind surfaces on the material which were approximately parallel to the principal faces of the crystal. The basal plane (0001), the first-order prism face (10 $\bar{1}$ 0), the second-order prism face (11 $\bar{2}$ 0), and the pyramid face (10 $\bar{1}$ 1) were prepared in this way.

The reflexions from these faces of the X-rays from an anticathode of palladium were examined with the X-ray spectrometer †, and the results are shown in fig. 1.

Fig. 1.

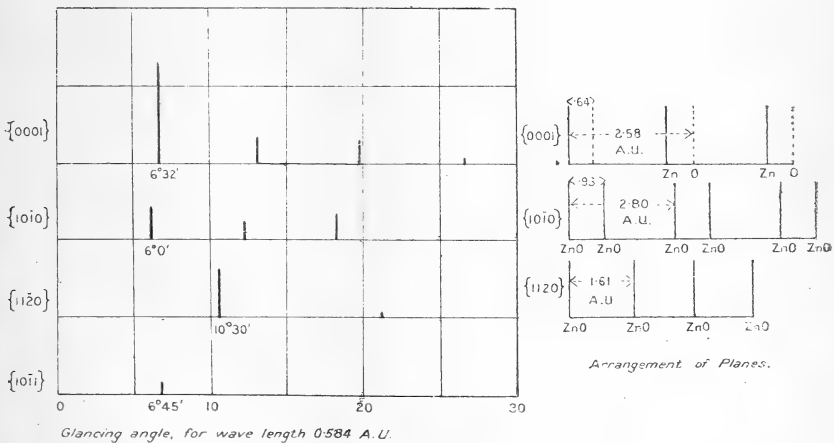

The structure assigned to the crystal by these results is shown by fig. 2, the positions of the centres of the zinc and

* Communicated by the Author.

† W. H. Bragg and W. L. Bragg, Proc. Roy. Soc. A. vol. lxxxviii. April 1913.

oxygen atoms being indicated by the small circles in the figure.

Fig. 2.

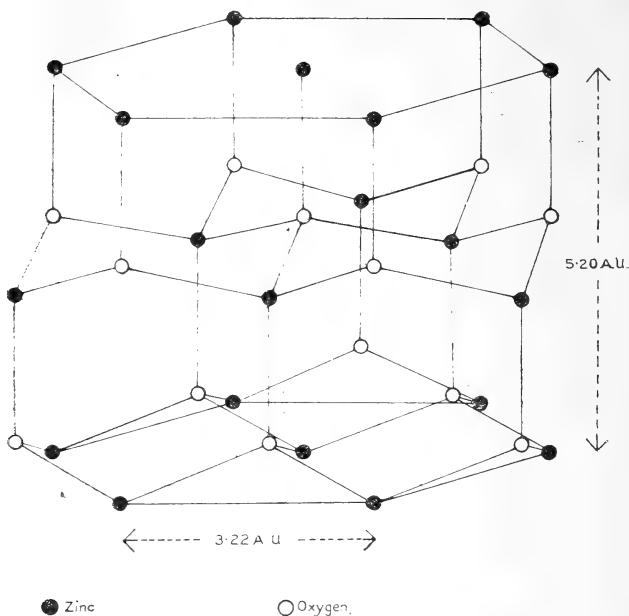

The atoms of zinc are arranged on two hexagonal space-lattices, their centres corresponding very closely with those of a set of equal spheres in hexagonal close-packing. For a close-packed hexagonal arrangement of equal spheres, the axial ratio may be calculated to be

$$a : c = 1 : 1.632.$$

The axial ratio in the case of zinc oxide is

$$a : c = 1 : 1.608.$$

The positions of the zinc atoms are identical with those of the hexagonal close-packed arrangement of spheres, if the latter be supposed to contract in the direction parallel to the hexagonal axis so as to reduce the ratio c/a from 1.632 to 1.608.

The oxygen atoms are light compared with the zinc atoms, and the spectra cannot be held to determine their positions exactly. In so far as they do this, they are in agreement with the supposition that the oxygen atoms are on two hexagonal space-lattices identical with those on which the

zinc atoms are situated, and derived from these latter by a movement of translation parallel to the c axis, which brings every oxygen atom into the centre of four zinc atoms arranged at the corners of what is very nearly a regular tetrahedron.

The dimensions of the structure are given in fig. 2. They are calculated from the axial ratio $c/a=1.608$ and the density of zinc oxide 5.78. That they agree with the dimensions measured by the angles of reflexion is shown by the following table:—

Plane.	Calculated Spacing.	Observed Spacing.
(0001)	$\frac{c}{2}=2.60$ A.U.	2.58 A.U.
(1010)	$\frac{a\sqrt{3}}{2}=2.79$ A.U.	2.80 A.U.
(1120)	$\frac{a}{2}=1.61$ A.U.	1.61 A.U.
(1011)	2.46 A.U.	2.47 A.U.

In the case of the basal plane (0001) the successive planes are arranged as shown in fig. 1, oxygen and zinc atoms being arranged on alternate planes. The oxygen planes divide the distance between the zinc planes approximately in the ratio 1:3, thus explaining the small second-order reflexion and the large third-order reflexion.

The first-order prism face shows an abnormally large third-order reflexion, corresponding to the spacing of the planes parallel to that face. The planes represent the centres of equal numbers of zinc and oxygen atoms, and are so spaced that the distances between successive planes are alternately 0.93 A.U. and 1.87 A.U., thus reinforcing the third-order reflexion.

The symmetry of the crystal structure is dihexagonal polar. The polar nature of the hexagonal axis is shown by the arrangement of the planes (0001).

Cadmium sulphide, CdS, and wurtzite, ZnS, are isomorphous. Like zincite, their symmetry is of the dihexagonal polar type, and the axial ratio is very nearly the same for the three crystals.

ZnO	$a : c = 1 : 1.608$
ZnS	$a : c = 1 : 1.635$
CdS	$a : c = 1 : 1.622$

Close packed structure ... $a : c = 1 : 1.632$

The analysis of the structure of wurtzite is of especial interest, as zinc sulphide crystallizes in another form, zinc-blende, which is cubic.

If CdS and ZnS possess the same structure as ZnO, calculation shows that the reflexion from the basal plane should occur at the following angles:—

Plane (0001)	ZnS	5°	17'
,,	,,	CdS	5° 0'

Wurtzite occurs naturally only as a fibrous crystalline mass, and a crystal sufficiently large to measure was not available. Greenockite is a rare mineral occurring as very small crystals. Dr. Gordon, of King's College, London, very kindly lent an unusually large crystal of greenockite for this investigation, and a well-defined reflexion from the basal plane was found at an angle of 5° 2', thus affording confirmation of the assumption that the structure is the same as that of zinc oxide. It is hoped to make further measurements on this crystal.

Wurtzite shows a platy structure parallel to the fibres of the crystalline mass, and when this material was mounted in the spectrometer a faint reflexion at a glancing angle of 5° 20' was obtained, indicating that the basal planes of the crystals were parallel to the fibres. The effect was so small that very little reliance can be placed on this measurement; further observations are necessary to confirm it.

It is of interest to compare these structures with that of zinc-blende. In zinc-blende the zinc atoms are arranged on a face-centred cubic lattice, of side 5.42 A.U. The oxygen atoms are on a similar lattice, derived from the former by a movement of translation which brings each oxygen atom into the centre of four zinc atoms arranged on the corners of a regular tetrahedron. The trigonal axes in zinc-blende are polar. If the structure of wurtzite is the same as that of zinc oxide, as would appear to be the case, then in the crystals both of zinc-blende and wurtzite, every atom of sulphur is surrounded by four atoms of zinc at the corners of a regular tetrahedron, and every atom of zinc by four sulphur atoms similarly arranged. The dimensions of the structures are also almost identical. In wurtzite, for example, the distance between neighbouring zinc atoms is 3.85 A.U., in zinc-blende it is 3.83 A.U. The arrangement of the planes parallel to the plane (0001) of wurtzite is the same as that of the planes (111) in zinc-blende, the axis perpendicular to the planes being in each case polar.

The experiments described in detail in this paper were for the main part carried out in 1914, and a short reference to the results was made in "X Rays and Crystal Structure."

I wish to express my gratitude to Dr. Hutchinson, of the Mineralogical Laboratory, Cambridge, and Dr. Gordon, of King's College, London, for their kindness in supplying the material used, and to Mr. W. R. James, who assisted me in making some of the observations.

LXIV. *A Fluid Analogue for the Æther.* By Dr. G. GREEN,
*Lecturer on Natural Philosophy in the University of
Glasgow**

THE purpose of the present paper is merely to illustrate by means of an analogy certain points of resemblance (especially with reference to wave-propagation) between the æther and ordinary fluids, to some of which particular attention has not hitherto been drawn. The conception of the æther as a fluid medium has already been very fully discussed † and it is known to be subject to important limitations. Nevertheless it is desirable at the present time that the relations of matter and æther should be examined in every possible aspect, and the analogy now to be considered, though in itself incomplete, may be of interest as an illustrative system, and possibly also in its bearing upon some problems of the æther still requiring solution. Recent experimental observations have compelled us to modify certain ideas regarding the physical characteristics to be associated with the æther, in proving that the æther is capable of acting as a very slightly refracting medium in strong gravitational fields. This discovery has to some extent suggested the line of comparison between æther and ordinary matter which is followed in the present paper.

One of the main functions to be fulfilled by the æther is the apparently two-fold function of conveying waves of light and of electric and magnetic force at a constant velocity and of propagating the forces of gravitation. There have been associated with the æther certain elastic qualities enabling it to transmit transversal vibrations and at the same time to transmit a stress analogous to tensional stress in elastic material; and it is natural to

* Communicated by the Author.

† See FitzGerald, Proc. Roy. Dublin Soc. vol. ix. (1899).

suppose that all these different qualities will be concerned in the propagation of waves. We are accordingly led to look for an analogue to the æther in a material medium, in which the propagation of waves is governed by two apparently dissimilar motive influences. This is of course the case with water in which the waves travel under the influence of gravity and of surface tension combined; and we shall commence by showing that in water, under certain circumstances, all waves of a particular type are propagated at a very nearly uniform velocity.

The well known expression for the velocity of a wave in water of any depth, h , is

$$U = \sqrt{\left(\frac{g}{m} + Tm\right) \tanh mh}, \quad . . . \quad (1)$$

where $2\pi/m$ represents the wave-length under consideration, and T the value of the surface tension. This expression indicates that there is a minimum velocity of wave-propagation corresponding to a certain wave-length for which the value of m is determined by the root of the equation—

$$\frac{g + Tm^2}{g - Tm^2} = \frac{\sinh 2mh}{2mh} \quad (2)$$

The wave-length which corresponds to the minimum velocity of wave-propagation we shall refer to as the critical wave-length. For very deep water, the minimum velocity is associated with a wave-length for which $m^2 = g/T$. As the depth is diminished the minimum velocity is associated with a greater and greater critical wave-length. Ultimately the critical wave-length itself is greater than the depth when the water is very shallow. It is to be noticed, however, that when the depth is diminished below a certain value, not far different from half a centimetre, equation (2) has no positive real root and there is then no minimum wave-velocity. But in those cases where the depth is moderate, and a minimum velocity of wave-propagation obtains, the value of the minimum velocity is given by

$$U' = \frac{\sinh mh}{mh} \sqrt{(g - Tm^2)h}, \quad \quad (3)$$

where m is again determined by equation (2). It is easy to verify from (3) that, when h is small, the speed of all waves whose length exceeds the critical wave-length is practically constant and equal to the limiting speed, \sqrt{gh} , of a long wave in water of depth h . We have therefore

in shallow water a medium which transmits waves whose length exceeds the critical wave-length at an almost constant velocity and also transmits a certain stress between solid bodies floating on its surface.

According to the analogy suggested above, long waves in shallow water correspond to luminous or electromagnetic waves in æther, and the forces of attraction exhibited between bodies floating on the surface of water correspond to the forces of gravity propagated through the æther. From the standpoint of this analogy, it is significant that, though gravity and surface tension are both concerned in the propagation of waves, the influence of surface tension practically disappears in the case of the longer waves, while its influence predominates in the case of the shorter waves. The suggestion this contains with respect to æther waves is that the agencies which give rise to gravitational attraction between bodies in æther are also concerned in the propagation of luminous and electromagnetic waves, though they may play only a subordinate part in their propagation. The actual law of speed for different wave-lengths given in (1) may be taken as illustrating only certain possibilities of the case for æther gravitational waves. If, however, we adhere closely to the analogy between æther gravitational waves and waves in water for which the motive influence governing the wave-motion is mainly surface tension, we would then expect to find waves in æther governed mainly by the agencies which give rise to gravitational attraction. These waves would be shorter than any hitherto observed, and the law of velocity of propagation of the waves would be—velocity inversely proportional to square-root of wave-length.

The comparison of the mode of action of gravitation with that of surface tension leads us on to an interesting similarity between the two systems compared. In the immediate neighbourhood of any body at rest or in motion on the surface of a shallow fluid, there is owing to surface tension a region within which the depth of the fluid is sensibly different from the uniform depth obtaining at some distance from any solid body. Any portion of a plane wave, in passing close to the edge of a solid body, would therefore be subjected to an alteration in its speed of propagation corresponding to the alteration in depth of the fluid. Thus the waves would suffer a certain amount of deviation from a rectilinear path. This effect produced by the presence of solid bodies upon waves in water is evidently analogous to the bending of luminous waves from their path in a strong gravitational

field, such as that found in the immediate neighbourhood of the sun, at the total Solar eclipse of May 29, 1919.

Another important suggestion contained in the analogy between the longer waves in shallow water and luminous and electromagnetic waves in the æther is—that the velocity of light in æther is according to this analogy to be regarded as a minimum wave-velocity. Just as the minimum wave-velocity in water can be determined from equations (1) and (2) above, as a determinate function of g , h , and T , so the analogy leads us to expect to find some definite relation between the velocity of light, the elastic constant or the density of the æther and the constant of gravitation. The view that the velocity of light in æther is to be regarded as a minimum is of importance also later on when we come to consider the phenomena accompanying the motion of particles through the æther at speeds approaching the velocity of light in their relation to analogous phenomena in ordinary fluids.

The similarity existing between the two media, shallow water and æther, with respect to the propagation of waves is not confined to general relations between wave-length and speed of propagation. It can readily be verified for example that the ordinary laws of reflexion and refraction are obeyed in the case of shallow-water waves travelling in fluid which is otherwise at rest. In addition, it is clear that all phenomena involving the Doppler effect would obtain in ordinary fluids. By suitable suppositions regarding the relations between matter and æther it is also possible to extend the analogy so as to include a representation of the refraction and dispersion of æther waves in passing through material bodies. Inasmuch as a sudden increase in the depth of the fluid would involve an alteration in the velocity of waves in such a way as to cause this to vary according to the wave-length—a region of greatly increased depth might be regarded as corresponding in the analogy to a dispersive medium. It would be impossible, however, to represent the various forms of dispersive media by means of a variation in the depth of the fluid alone. A much more complete representation of dispersion and refraction of luminous waves on passing from æther into matter can be obtained by assuming the matter to be represented by a portion of space permeable by the fluid containing a very large number of vibrators having periods of their own. In the number and values of the natural periods of the vibrators, and in variations of their density, and in the closeness or openness of their arrangement within the fluid,

a wide range of dispersive qualities is provided for. If a system of vibrators of the type suggested here were in steady motion through the fluid, it has been demonstrated* that there would be a certain convection of the fluid in the region occupied by the vibrators; and a convection coefficient has been obtained in agreement with that required by the theory given by H. A. Lorentz † in 1895.

We come now to consider the motion of solid bodies at various speeds through water in its bearing upon the effects observed in the case of motion of bodies at increasing speeds through the *æther*. In this connexion the analogy between the *æther* and an ordinary fluid has been very fully discussed, especially with reference to the theory advanced by Sir George Stokes in 1845 to account for aberration. It is not the intention meantime to discuss Stokes's theory except in its direct relation to the particular form of the fluid analogue for *æther* with which we are at present concerned. Stokes assumed that the Earth and the planets in their motion would set the *æther* in motion, just as any solid in translational motion within an incompressible fluid would communicate motion to the fluid. Later writers have referred to Stokes's theory as directly applicable to all solids in motion. But, from the standpoint of the present comparison between *æther* and water, it does not appear to be consistent with the analogy to suppose that all actual solids would set the *æther* in motion in the manner described. In particular it seems a more natural comparison to make between the *æther* and an ordinary fluid, if we regard all solids which freely transmit luminous and electromagnetic waves as being more or less freely permeable also by the *æther*. This would appear to exclude from the application of Stokes's theory all transparent bodies and certain dielectrics, and it would remove one of the outstanding difficulties in the way of the acceptance of Stokes's theory ‡.

An important objection to Stokes's theory has been pointed out by H. A. Lorentz §. If the *æther* be an incompressible fluid, its irrotational motion would be completely determined by the normal component velocity alone

* See R. A. Houstoun, "Fizeau's Experiment and the *Æther*," *Phil. Mag.* vol. xxxvii. p. 214 (1919).

† 'Versuch einer Theorie der Electricischen und Optischen Erscheinungen in Bewegten Körpern,' p. 101 (1895).

‡ The difficulty referred to is to account for the experimental result obtained by Rowland, Röntgen, and Eichenwald.

§ *Archives Néerl.* xxi. p. 103 (1896).

at each point of a solid in motion within it. Unless the component of velocity of fluid at each point tangential to the solid were the same as the tangential velocity of the point of the solid in contact with it, the æther in contact with any solid would in general have a motion relative to the solid. The same writer, however, showed later, in discussing a suggestion put forward by Planck, that the condition that the æther should have no motion relative to the Earth would be fulfilled if the æther in contact with the Earth were compressible in accordance with Boyle's law, and at the same time subject to gravity. It is remarkable that if these assumptions were correct there would be a condensation of æther around the heavenly bodies such as would account for the deflexion of light from its path as observed at the recent eclipse.

Whether the above suggested explanation of the difficulty is correct or not, the essential point with respect to Stokes's theory is that it accounts for aberration provided the steady irrotational motion of the æther arising from the translational motion of the Earth is very large in comparison with any other motion of the æther which may depend on the rotational motion of the Earth, and which may exist along with the irrotational motion. Arguing from the conditions presenting themselves in the analogous system which we are considering*, we can admit at least the possibility that this may be the case. In the analogy, the Sun and planets correspond to bodies in motion, rotational and translational, upon the surface of shallow water, the motion being very slow in comparison with the minimum wave-speed in the fluid. The motion of the fluid which is produced by the motion of the solids would in this case be irrotational except for a very small part depending on the motion of rotation of the solid bodies, and ultimately on the very small degree of viscosity within the fluid. An infinitesimal degree of viscosity within the fluid would give complete fulfilment of the condition that the fluid in contact with each solid would have no motion relative to the solid, while the corresponding rotational motion within the fluid would be negligible in comparison with the irrotational motion of the fluid arising from the motion of translation of the solid. It thus appears that the fluid motion in the neighbourhood of each of the moving solids fulfils exactly the conditions required to be fulfilled in a fluid æther as indicated by the

* These conditions resemble closely the conditions contemplated by Stokes in his papers—*Phil. Mag.* vol. xxix. p. 6 (1846), and vol. xxxiii. p. 343 (1848).

Michelson and Morley experiment and other experiments of the same type. The fluid analogue also fulfils the conditions to be fulfilled by a fluid æther in this other important detail—namely in that a very small degree of viscosity in the fluid has a practically insensible effect in tending to extinguish waves of any length exceeding the critical wave-length, while its influence is sensible in the case of the very short waves*.

Very few, if any, theoretical investigations have been made of the fluid motion which is produced by bodies moving uniformly on the surface of a fluid, at speeds increasing up to, but not actually attaining to, the minimum wave-speed in the fluid †. Nevertheless the general nature of the effects to be observed can readily be inferred from experience and from the theoretical results obtained for the sphere and other solids in uniform motion in an infinite liquid. As no wave-motion is possible within the fluid so long as the speed of the solid does not exceed the minimum wave-speed, the main disturbance within the fluid will clearly be a steady, or nearly steady, motion confined to the immediate neighbourhood of the moving solid. There is accordingly no difficulty in recognizing that the action of the total fluid pressure upon a solid moving within it, or on its surface, would be equivalent in effect to an increase in the inertia of the solid. If the velocity of any solid be continuously increased from very small values, it is clear that the apparent inertia of the solid would also continuously increase, as the mass of fluid set in motion by the solid became greater and greater.

When we come to consider the fluid motion arising from the motion of a solid on the surface of a fluid at a speed exactly equal to the minimum wave-speed in the fluid, we have, however, the theoretical guidance we require in the investigation by the late Lord Rayleigh just referred to. The result obtained is that, in the entire absence of friction within the fluid, the amplitude of the resulting fluid motion is infinite; and when only a small retarding force proportional to the velocity, (αv), acts at each point of the fluid, the amplitude of the fluid motion arising from the uniform motion of the solid is proportional to $(1/\sqrt{\alpha})$, an exceedingly large quantity. If a solid in steady motion at a speed equal to the minimum wave-speed were suddenly brought to rest by an obstacle, a fluid pulse of large amplitude would be reflected from the obstacle into the

* Lamb's 'Hydrodynamics,' 3rd ed. § 331.

† See, however, "Standing Waves on the Surface of Running Water," Proc. Lond. Math. Soc. vol. xv. no. 219.

surrounding region. Moreover the energy of wave-motion constituting this pulse would be associated with the critical wave-length as a predominant wave-length; that is to say, the greater part of its energy is associated with waves whose wave-lengths differ little from the critical wave-length*. It thus appears that the apparent inertia of a solid mass moving steadily in, or on the surface of, a fluid would be greater and greater for increasing values of the speed of the mass for all speeds up to the minimum wave-speed. When a uniform speed equal to the minimum wave-speed in the fluid is attained by the solid, its apparent inertia then becomes infinite. The apparent increase in the inertia of a solid with speed, is in reality due to the reaction of the fluid set in motion by the solid which would act in a direction tending to stop the motion of the solid. Whether it would also tend to produce a contraction of the solid in the direction of its motion has not yet been definitely established by analysis, though this seems to be very probable.

The above considerations clearly indicate that there is a very close general similarity between the apparent increase in the inertia of bodies moving in a fluid, and the corresponding apparent increase of inertia of electrons moving through æther at speeds increasing up to, and also equal to, the velocity of light. In addition to this general resemblance between the æther and an ordinary fluid with respect to the motion of solid bodies within each, we have, in the X-rays, evidence of the existence of wave-disturbances of very large amplitude in the æther arising from the motion through it of particles moving at the speed of light, corresponding closely to the waves of large amplitude in water arising from the motion of solid bodies in water at a speed equal to the minimum wave-speed.

The analogy which we have been examining suggests other points of comparison between the interactions of matter and æther on the one hand and the interactions of ordinary solids and fluids on the other. With respect to the physical quantities—momentum, force, energy, associated with the bodies moving in an invisible fluid such as the æther, the interpretation of the analogy is clear, or is virtually indicated in what precedes with reference to apparent increase of inertia. One additional point might, however, be mentioned in connexion with the motion of bodies in fluids. If the motion of a body on the surface of a fluid be an accelerated motion, this would evidently

* Proc. Roy. Soc. A, vol. lxxxix. pp. 583-4 (1914).

be accompanied by a change in the apparent magnitude of the force of attraction between the body and other bodies in its neighbourhood arising from surface tension. In the analogous system of the æther,—an apparent change in the gravitational force acting on a body would be observed in the case of a body moving with accelerated motion in the æther.

In conclusion it should be remarked that there does not seem to be anything suggested by the analogy which we have been considering which is directly contrary to or inconsistent with the principle of relativity. At the same time it seems to encourage the view that it may yet be possible to detect absolute motion of the Earth in æther and that it may therefore also be possible to escape from a principle involving so much indefiniteness with respect to fundamental units. In one sense therefore this analogy seems to present an avenue of escape from the principle of relativity; for if the velocity of light is really a minimum wave-velocity in æther, then in the apparent changes of inertia of electrons as the velocity of light is approached and in the behaviour of the pulses constituting X-rays, we are beginning to be able to detect velocity relative to æther.

LXV. *Radioactivity and the Gravitational Field.* By ARTHUR H. COMPTON, *Ph.D.*, *National Research Fellow in Physics* *.

IT is well known that in order to account for the age and the present temperature of the earth, the average radioactivity of its component minerals must fall off rapidly a few miles below its surface. The high density of the radioactive minerals, however, makes it appear probable that they should occur more abundantly in the earth's interior than in the surface crust. Thus it appears that substances which at the earth's surface are radioactive may have practically no radioactivity in the earth's interior. These considerations suggest that the rate or energy of radioactive disintegration may be a function of the intensity or potential of the earth's gravitational field. This suggestion appears the more plausible since both radioactivity and gravitation are essential attributes of the atomic nucleus.

It has recently been pointed out by A. Donnan † that

* Communicated by Prof. Sir E. Rutherford, F.R.S.

† A. Donnan, 'Nature,' Dec. 17, 1919.

thermodynamic reasoning predicts a change in the energy evolved in radioactive disintegration when the potential of the gravitational field is varied. The following analysis shows, however, that this change is by no means large enough to account for the lack of radioactivity of the earth's interior. The cycle considered by Professor Donnan consists of the following four steps:—

1. A system at gravitational potential Z changes from state 1 to state 2, an amount of energy Q being liberated, which results in a change of mass from m_1 to m_2 .

2. The system in state 2 is raised from potential Z to $Z + \delta Z$.

3. At potential $Z + \delta Z$ the system is changed back from state 2 to state 1.

4. The system in state 1 is lowered from potential $Z + \delta Z$ to potential Z . Being then in its original condition, the total energy evolved by the system is zero, and it possesses its original mass.

If the change δZ in the gravitational potential is small, the total work done by the system in performing this cycle is

$$Q - m_2 \delta Z - \left(Q + \frac{\partial Q}{\partial Z} \delta Z \right) + m_1 \delta Z = 0,$$

or

$$\frac{\partial Q}{\partial Z} = m_1 - m_2,$$

which is the expression obtained by Donnan. If now we consider Q as a function of Z only, we may write

$$\frac{dQ}{Q} = \frac{m_1 - m_2}{Q} dZ.$$

Putting R as the ratio between the energy evolved and the mass which disappears, we have

$$m_1 - m_2 = Q/R,$$

whence

$$dQ/Q = dZ/R.$$

The difference in the gravitational potential between the surface and the centre of the earth is about $3 \times 10^{11} \text{ cm.}^2 \text{ sec.}^{-2}$, and the ratio R is of the order of the square of the velocity of light, or $10^{21} \text{ cm.}^2 \text{ sec.}^{-2}$. Hence the decrease from this cause in the energy of radioactive disintegration, being less than one part in a billion, is wholly inadequate to account for the small amount of heat developed in the earth's interior.

This thermodynamic relation between the energy of radioactive disintegration and the gravitational potential does not, however, exclude the possibility of a connexion of an intimate character between, for example, the intensity of the gravitational field and the *rate* of radioactive disintegration. It is the latter type of relation which the present experiments have been designed to detect.

According to Einstein's generalized theory of relativity, a gravitational accelerational field is essentially the same as a field of centrifugal acceleration. We have therefore tested the effect due to a change in the gravitational field by subjecting the radioactive material to a strong centrifugal acceleration. It was obvious that the maximum centrifugal acceleration which could be attained at the edge of a rotating wheel would fall far short of the mean acceleration to which the atomic nucleus is subject due to the thermal agitation of the atoms. There was a chance, however, that a comparatively steady acceleration might have an effect different from that of the rapidly varying molecular accelerations.

The Experiments.—A small tube of radium emanation was placed in a hole near the circumference of a brass disk of 10 cm. radius. The gamma radiation from the emanation was measured when the disk was rotating slowly and when turning at approximately 250 revolutions per second. The acceleration was thus varied from about 1.5 to about 20,000 times the acceleration of gravity.

The gamma radiation was measured by a balance method. The ionization due to the gamma rays traversing a large ionization chamber was balanced against an adjustable current passing through a high resistance, a highly sensitive electrometer being used to detect any difference between the two currents. For the high resistance a Bronson resistance was at first employed. This was later discarded in favour of a resistance consisting of lampblack on sulphur. The latter resistance, though more subject to variations over long periods, has the advantage that it introduces no short period probability variations such as those due to the ionization by discrete alpha particles when the Bronson resistance is used. The probability variations in the ionization current due to the gamma rays, such as have been observed by Meyer*, Laby† and others, were very noticeable in these measurements, and were the cause of practically the whole of the differences between successive measurements.

Altogether four extended series of measurements were

* Meyer, *Phys. Zeitschr.* xi. p. 1022 (1910).

† Laby, *Nature*, lxxxvii. p. 144 (1911).

made, comparing the intensity of the radiation when the emanation was subject to small and to large accelerations. The results of these tests were as follows:—

1. An increase due to acceleration of $(.08 \pm .07)$ per cent.
2. A decrease due to acceleration of $(.17 \pm .09)$ per cent.
3. A decrease due to acceleration of $(.17 \pm .07)$ per cent.
4. An increase due to acceleration of $(.02 \pm .10)$ per cent.

The average of all these tests indicates a decrease in the intensity of the gamma radiation of $(.06 \pm .04)$ per cent. It is probable, therefore, that an acceleration of 20,000 times gravity produces no effect on the intensity of gamma radiation as large as one part in a thousand.

In order to explain the small degree of radioactivity of the earth's interior it would be necessary to assume a comparatively large change due to an increase in the gravitational acceleration. The negative result of this experiment therefore shows that we must look elsewhere for the cause of the confinement of the earth's radioactivity to its surface crust.

I wish to thank Professor Rutherford for proposing this problem to me, and for his helpful suggestions and encouragement as the work progressed.

Cavendish Laboratory,
Cambridge University.
Feb. 3, 1920.

LXVI. *The Difference between Magnetic and Electric Energies as a Pressure.* By R. HARGREAVES, M.A.*

IN any electromagnetic field the pressure on a perfectly reflecting surface is normal, and is measured by the difference between the magnetic and electric energies (per unit volume) at the surface. This theorem, the subject of the present paper, may be viewed in conjunction with an analogous theorem in Hydrodynamics which appeared in this Magazine †. There it was shown that Kelvin's kinetic potential for the motion of solids in infinite liquid, with circulation taken into account, could be got by taking a volume integral of the pressure. The analogy is at once apparent, and may be helpful in explaining the *raison d'être* of the kinetic potential in Electromagnetics. For though

* Communicated by the Author.

† "A Pressure-integral as Kinetic Potential," Sept. 1908.

magnetic and electric energies are contrasted forms, the contrast is not exactly that between potential and kinetic energy in dynamics, since the electric energy is not dependent on position alone when there is motion—*i. e.* the analogy with dynamics is imperfect.

It is remarkable that the theorem has escaped attention in its application to the simple problem of reflexion of a plane wave at a fixed plane surface. Accordingly I take this case first, then deal with a moving plane surface, and finally take a general electromagnetic field near the surface of any perfect conductor in motion.

§ 1. If z constant is the surface on which a plane wave is incident, the conditions at the surface are $X=0, Y=0$; and these involve $c=0$, since $\frac{1}{V} \frac{\partial c}{\partial t} = \frac{\partial X}{\partial y} - \frac{\partial Y}{\partial x}$. Hence the normal pressure

$$\left. \begin{aligned} Z_z &= \frac{1}{2}(a^2 + b^2 - c^2) + \frac{1}{2}(X^2 + Y^2 - Z^2) = \frac{1}{2}(a^2 + b^2 - Z^2), \\ \text{and} \\ L &= \frac{1}{2}(a^2 + b^2 + c^2) - \frac{1}{2}(X^2 + Y^2 + Z^2) = \frac{1}{2}(a^2 + b^2 - Z^2), \end{aligned} \right\} (1)$$

have the same value at the surface: moreover $X_z = -ZX - ac$ vanishes, as also Y_z , so that the pressure is purely normal.

Consider the composition of these functions with reference to the separate waves. If (X_1, Y_1, Z_1) refer to the incident wave, then

$$l_1 X_1 + m_1 Y_1 + n_1 Z_1 = 0, \quad a_1 = m_1 Z_1 - n_1 Y_1, \dots (2)$$

For the reflected wave take the argument to be $l_2 x + m_2 y - n_2 z - Vt$, so that $(l_2, m_2, n_2) = (l_1, m_1, n_1)$. At the surface then we have the relations

$$(X_2, Y_2, Z_2) = (-X_1, -Y_1, Z_1), \quad (a_2, b_2, c_2) = (a_1, b_1, -c_1). (3)$$

The value of L at the surface is that of product terms, viz.,

$$\begin{aligned} L &= a_1 a_2 + b_1 b_2 + c_1 c_2 - (X_1 X_2 + Y_1 Y_2 + Z_1 Z_2) \\ &= a_1^2 + b_1^2 - c_1^2 + X_1^2 + Y_1^2 - Z_1^2. \dots (4a) \end{aligned}$$

On the other hand product terms in Z_z vanish at the surface, since

$$\begin{aligned} X_1 X_2 + Y_1 Y_2 - Z_1 Z_2 + a_1 a_2 + b_1 b_2 - c_1 c_2 \\ = -(X_1^2 + Y_1^2 + Z_1^2) + a_1^2 + b_1^2 + c_1^2. \end{aligned}$$

The pressure is shown in the Z_z formula by the sum of

separate parts for incident and reflected waves; for the first

$$Z_z(1) = \frac{1}{2}(a_1^2 + b_1^2 - c_1^2) + \frac{1}{2}(X_1^2 + Y_1^2 - Z_1^2), \quad (4b)$$

and an equal value for the second.

To evaluate this in terms of $E_1 = \frac{1}{2}(a_1^2 + b_1^2 + c_1^2) + \frac{1}{2}(X_1^2 + Y_1^2 + Z_1^2) = X_1^2 + Y_1^2 + Z_1^2$, use

$$\begin{aligned} c_1^2 + n_1^2 Z_1^2 &= (l_1 Y_1 - m_1 X_1)^2 + (l_1 X_1 + m_1 Y_1)^2 \\ &= (X_1^2 + Y_1^2)(1 - n_1^2) = (E_1 - Z_1^2)(1 - n_1^2), \\ \text{or } c_1^2 + Z_1^2 &= E_1(1 - n_1^2), \text{ and so } Z_z(1) = n_1^2 E_1. \quad (5) \end{aligned}$$

The pressure $2E_1 n_1^2$ of both waves is given by (4a).

The flux of energy has a property like Z_z as to its product terms; for

$$X_1 b_2 - Y_1 a_2 + X_2 b_1 - Y_2 a_1 = X_1 b_1 - Y_1 a_1 - X_1 b_1 + Y_1 a_1 = 0.$$

The flux is therefore assessed as the sum for the separate waves: for the incident wave

$$\begin{aligned} V(X_1 b_1 - Y_1 a_1) \\ = V X_1(n_1 X_1 - l_1 Z_1) - V Y_1(m_1 Z_1 - n_1 Y_1) = V n_1 E_1, \end{aligned}$$

for the reflected wave $-V n_2 E_2$, with a total flux vanishing because there is no loss of energy.

§ 2. With a moving surface of reflexion there is loss of energy, and the formulæ are sensibly modified. The boundary conditions are now

$$X - wb/V = 0, \quad Y + wa/V = 0; \text{ these involve } c = 0, \quad (6)$$

as before, for at the moving surface

$$\frac{1}{V} \left(\frac{\partial}{\partial t} + w \frac{\partial}{\partial z} \right) c = \frac{\partial}{\partial y} \left(X - \frac{wb}{V} \right) - \frac{\partial}{\partial x} \left(Y + \frac{wa}{V} \right).$$

The relative flux of energy, and the modified pressure formula, are shown in the equation

$$V(Xb - Ya) - wE = w\{Z_z - w(Xb - Ya)/V\}, \quad (7)$$

valid because the difference between its members is

$$V[(X - wb/V)(b - wX/V) - (Y + wa/V)(a + wY/V)],$$

a quantity which vanishes in virtue of (6). The meaning of (7) is that the relative flux of energy is equal to the work done on the moving face by the pressure. Since

$$\begin{aligned} Z_z - w(Xb - Ya)/V &= L + X(X - wb/V) \\ &\quad + Y(Y + wa/V) - c^2, \quad (8) \end{aligned}$$

the pressure is still given by the value of L , as other terms on the right hand vanish. A component of tangential stress is now $X_z - w(Yc - Zb)/V$ or $-Z(X - wb/V) - c(a + wY/V)$, which vanishes.

To deal with the separate waves write $X_1 + X_2$ for X , and take (6) in conjunction with

$$\begin{aligned} p_1 l_1 &= p_2 l_2, & p_1(V - wn_1) &= p_2(V + wn_2), \\ p_1 m_1 &= p_2 m_2, & p_1(Vn_1 - w) &= p_2(Vn_2 + w), \end{aligned} \quad \dots \quad (9)$$

which bring the arguments $p_1(l_1x + m_1y + n_1z - Vt)$ and $p_2(l_2x + m_2y - n_2z - Vt)$ into agreement for $z - wt = \text{constant}$. Using (6) with multipliers $p_2 l_2$, $p_2 m_2$, we get $Z_1 = Z_2$; then, quoting (5),

$$\begin{aligned} E_1(1 - n_1^2) &= c_1^2 + Z_1^2 = c_2^2 + Z_2^2 = E_2(1 - n_2^2), \\ \text{and} \quad E_2 &= E_1 p_2^2 / p_1^2 \quad \dots \quad (10) \end{aligned}$$

connects the energies of incident and reflected waves. With multipliers $X_1 Y_1$, (6) yields

$$\Sigma X_1 X_2 = -E_1 p_2 / p_1 + 2V^2 Z_1^2 / (V^2 - w^2). \quad \dots \quad (11)$$

Then $L = \Sigma a_1 a_2 - \Sigma X_1 X_2$

$$\begin{aligned} &= (l_1 l_2 + m_1 m_2 - n_1 n_2 - 1) \Sigma X_1 X_2 - (l_2 X_1 + m_2 Y_1 \\ &\quad - n_2 Z_1)(l_1 X_2 + m_1 Y_2 + n_1 Z_2) \\ &= \{ -E_1 p_2 / p_1 + 2V Z_1^2 / (V^2 - w^2) \} \{ -2(Vn_1 - w)^2 \\ &\quad \times p_1 / p_2 (V^2 - w^2) \} + (p_1 n_1 + p_2 n_2)^2 Z_1^2 / p_1 p_2. \end{aligned}$$

Writing $p_1 n_1 + p_2 n_2 = V(p_1 - p_2) / w$ from (9), the Z_1 section vanishes through $p_2(V^2 - w^2) = p_1(V^2 + w^2 - 2Vwn_1)$, and finally

$$L = 2E_1(Vn_1 - w)^2 / (V^2 - w^2). \quad \dots \quad (12)$$

If the calculation of pressure is made through the Z_z formula (modified), the demonstration of the vanishing of product terms is the troublesome part. It follows from

$$\left. \begin{aligned} X_2 - wb_2/V + X_1(1 - wn_1/V) + wl_1 Z_1/V &= 0, \\ a_2 + wY_2/V + Y_1(n_1 - w/V) - m_1 Z_1 &= 0, \end{aligned} \right\} \quad (13)$$

and associated formulæ. The parts of the pressure are given by square terms, viz, $E_1 n_1(n_1 - w/V)$ and $E_2 n_2(n_2 + w/V)$, with ratio $p_1 n_1 : p_2 n_2$.

Flux of energy and work done by pressure are shown very simply by interpreting

$$E_1(Vn_1 - w)(1 - wn_1/V) = E_2(Vn_2 + w)(1 + wn_2/V), \quad (14)$$

which is an immediate consequence of (10) and (9), as difference of two fluxes giving work done by pressure.

§ 3. To deal with a conductor in a general electromagnetic field, the properties of the ideal conductor in virtue of which its interior is an electromagnetic blank need consideration. For this purpose the field equations are integrated through a layer in which a rapid transition is made from finite to zero values, and the volume of integration has a cross-section dS with thickness small in comparison with the linear dimensions of dS . Such integration gives

$$\int \frac{\partial f'}{\partial v} d\tau = \int \frac{\partial f'}{\partial v} dv dS = f dS, \quad \text{and} \quad \int \frac{\partial f'}{\partial x} d\tau = lf dS, \quad (15a)$$

l a direction-cosine of the normal, and f a value just outside the surface.

To deal with $\frac{\partial f'}{\partial t}$ we note that in respect to $\frac{df'}{dt}$ or $\frac{\partial f'}{\partial t} + u \frac{\partial f'}{\partial x} + v \frac{\partial f'}{\partial y} + w \frac{\partial f'}{\partial z}$ rapid change is obviated because the motion of an element is followed, and accordingly a zero value is given for the integral of $\frac{df'}{dt}$ in consequence of the small thickness of the layer. Thus

$$\begin{aligned} \int \frac{\partial f'}{\partial t} d\tau &= - \int \left(u \frac{\partial f'}{\partial x} + v \frac{\partial f'}{\partial y} + w \frac{\partial f'}{\partial z} \right) d\tau = - (lu + mv + nw) dS \\ &= -v_v dS, \text{ say.} \end{aligned} \quad (15b)$$

Applying these to the volume-integrals of $\rho = \Sigma \frac{\partial X}{\partial x}$. $\frac{1}{V} \frac{\partial X}{\partial t} + \frac{\rho u_e}{V} = \frac{\partial c}{\partial y} - \frac{\partial b}{\partial z}$, $\frac{1}{V} \frac{\partial a}{\partial t} = \frac{\partial Y}{\partial Z} - \frac{\partial Z}{\partial y}$, we have results:

$$\sigma = lX + mY + nZ, \quad \dots \quad (16)$$

$$-v_v X/V + \sigma u_e/V = mc - nb, \quad \dots \quad (17)$$

$$av_v/V = mZ - nY. \dots \quad (18)$$

It is not assumed that the velocity ($u_e v_e w_e$) attributed to charge at the surface agrees with the velocity (uvw) of the material surface. But (16) and (17) demand the condition

$\Sigma lu_e = v_v = \Sigma lu$, or agreement of normal components, a condition which also follows from integrating $\frac{\partial \rho}{\partial t} + \frac{\partial}{\partial x'}(\rho v_e) + \dots = 0$ as above. The group (16) (17) (18) yields

$$X(1 - v_v^2/V^2) = \sigma(l + u_e v_v/V^2), \quad a(1 - v_v^2/V^2) = \sigma(nr_e - mw_e)/V. \quad (19)$$

We have therefore expressions for surface values in terms of σ and $(u_e v_e w_e)$. The formulæ for which we have immediate use are :

$$\xi \equiv X + \frac{v_e c - w_e b}{V} = \sigma l(1 - \Sigma u_e^2/V^2)/(1 - v_v^2/V^2), \quad (20)$$

$$\Sigma a^2 - \Sigma X^2 = -\sigma^2(1 - \Sigma u_e^2/V^2)/(1 - v_v^2/V^2), \quad (21)$$

$$a + (w_e Y - v_e Z_e)/V = 0, \quad (22)$$

$$\Sigma a^2 = \Sigma u_e(Yc - Zb)/V. \quad (23)$$

From (20) and (21) we derive

$$\frac{l}{2}(\Sigma a^2 - \Sigma X^2) = -\sigma \xi / 2. \quad (24)$$

According to the well-known method of getting the force due to the transition layer, the right-hand member represents a component of the inward force. The force is therefore a pressure $\frac{1}{2}(\Sigma a^2 - \Sigma X^2)$ normal to the surface. This pressure is negative, as for the statical problem, with modifying factors due to the motion.

The relation (22) is quoted as leading immediately to (23), from which

$$E + L = \Sigma u_e(Yc - Zb)/V. \quad (25)$$

If the value of L in (21) is differentiated with regard to u_e , the result is found to agree with the value of $(Yc - Zb)/V$ as obtained from (19). Thus

$$\frac{\partial L}{\partial u_e} = (Yc - Zb)/V, \quad \text{and} \quad E = u_e \frac{\partial L}{\partial u_e} + v_e \frac{\partial L}{\partial v_e} + w_e \frac{\partial L}{\partial w_e} - L; \quad (26)$$

and in respect to these surface values per unit volume we have the normal relation connecting energy with kinetic potential.

LXVII. *The Diffraction of Waves by a Semi-infinite Screen with a Straight Edge.* By W. G. BICKLEY, B.Sc., Assistant Lecturer in Mathematics, Battersea Polytechnic*.

§ 1. SINCE Sommerfeld gave the first exact mathematical solution of the problem of the diffraction of waves by a semi-infinite screen with a straight edge, several other writers have attempted to obtain the same result by simpler analysis. Some have achieved "simplicity" by introducing assumptions not easily justified *a priori*, while others have used methods which are tantamount to assuming the known form of the solution. It is hoped that the following is free from these defects. It is an extension of the method used by Prof. Lamb † for perpendicular incidence, to the case of oblique incidence.

§ 2. The problem is, in the first instance, two-dimensional. The trace of the screen will be taken as the positive half of the x axis. The incident waves will be considered to

Fig. 1.

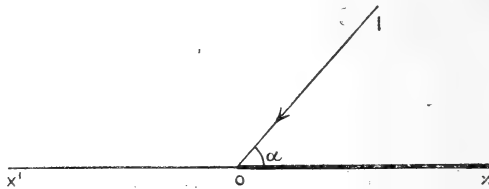

advance in a direction parallel to IO (fig. 1), and the angle IOX will be denoted by α . Then the incident waves will be given by

$$\phi_i = e^{-ik(x \cos \alpha + y \sin \alpha + ct)}, \quad (\nabla^2 + k^2)\phi_i = 0, \quad (1)$$

where c is the wave velocity, and $k = 2\pi/(\text{wave-length})$.

It will be shown that the boundary conditions can all be satisfied by expressions representing transmitted and reflected waves,

$$\phi_t = u e^{-ik(x \cos \alpha + y \sin \alpha + ct)}$$

$$\text{and } \phi_r = v e^{-ik(x \cos \alpha - y \sin \alpha + ct)} \quad \text{respectively,}$$

u and v being functions of x and y alone.

* Communicated by the Author.

† P. L. M. S. (2) vol. iv.; 'Hydrodynamics' (4th ed.) p. 535.

Transferring to parabolic coordinates, ξ, η , given by $x + iy = (\xi + i\eta)^2$, the equation $(\nabla_1^2 + k^2)\phi = 0$ gives

$$\frac{\partial^2 u}{\partial \xi^2} + \frac{\partial^2 u}{\partial \eta^2} - 4ik \left\{ (\xi \cos \alpha + \eta \sin \alpha) \frac{\partial u}{\partial \xi} + (\xi \sin \alpha - \eta \cos \alpha) \frac{\partial u}{\partial \eta} \right\} = 0. \quad (2)$$

This equation is found to have a solution

$$u = f(a\xi + b\eta) \quad \text{if} \quad a = \cos \frac{\alpha}{2}, \quad b = \sin \frac{\alpha}{2},$$

in which case the equation to determine f becomes

$$f'' - 4ik \left(\xi \cos \frac{\alpha}{2} + \eta \sin \frac{\alpha}{2} \right) f' = 0, \quad \dots \quad (3)$$

$$\therefore f' = A + B \int^{\xi \cos \frac{\alpha}{2} + \eta \sin \frac{\alpha}{2}} e^{2ik\zeta^2} d\zeta = u. \quad \dots \quad (4)$$

In the same way we find

$$v = C + D \int^{\xi \cos \frac{\alpha}{2} - \eta \sin \frac{\alpha}{2}} e^{2ik\zeta^2} d\zeta. \quad \dots \quad (5)$$

Therefore for the whole potential we have

$$\phi = e^{-ik\beta} \left\{ A + B \int_0^{\omega_1} e^{2ik\zeta^2} d\zeta \right\} + e^{-ik\gamma} \left\{ C + D \int_0^{\omega_2} e^{2ik\zeta^2} d\zeta \right\} \quad \dots \quad (6)$$

(ϕ_i included in A), where for brevity we have written

$$\left. \begin{aligned} x \cos \alpha + y \sin \alpha + ct &= \beta, & x \cos \alpha - y \sin \alpha + ct &= \gamma, \\ \xi \cos \frac{\alpha}{2} + \eta \sin \frac{\alpha}{2} &= \omega_1, & \xi \cos \frac{\alpha}{2} - \eta \sin \frac{\alpha}{2} &= \omega_2, \end{aligned} \right\} \quad (7)$$

and the lower limit zero has been introduced, for definiteness, into the integrals.

§ 3. It now remains to satisfy the boundary and other

conditions by finding suitable values of the constants A, B, C, and D. For points far to the left (x negative), η is great compared with ξ . Here $\phi \rightarrow \phi_i$, so that, using the first terms of the asymptotic expansions of the integrals, we get

$$1 = A + \frac{1}{2}B\sqrt{\frac{\pi}{2k}}e^{i\frac{\pi}{4}}, \quad 0 = C - \frac{1}{2}D\sqrt{\frac{\pi}{2k}}e^{i\frac{\pi}{4}}. \quad (8)$$

For the boundary conditions on the plane, where $\eta=0$, we may have two cases :

Case I. $\phi=0$. Then

$$A + C = 0, \quad B + D = 0, \quad \dots \dots \dots (9)$$

giving, with (8) above,

$$A = -C = \frac{1}{2}, \quad B = -D = \sqrt{\frac{2k}{\pi}}e^{-i\frac{\pi}{4}} \quad (10)$$

Case II. $\frac{\partial\phi}{\partial y}=0$. Then

$$A - C = 0, \quad B - D = 0, \quad \dots \dots \dots (9')$$

giving, with (8),

$$A = C = \frac{1}{2}, \quad B = D = \sqrt{\frac{2k}{\pi}}e^{-i\frac{\pi}{4}}. \quad (10')$$

So both cases may be included in

$$\begin{aligned} \phi = \frac{1}{2} \left[e^{-ik\beta} \left\{ 1 + 2\sqrt{\frac{2k}{\pi i}} \int_0^{\omega_1} e^{2ik\zeta^2} d\zeta \right\} \right. \\ \left. \mp e^{-ik\gamma} \left\{ 1 + 2\sqrt{\frac{2k}{\pi i}} \int_0^{\omega_2} e^{2ik\zeta^2} d\zeta \right\} \right]; \quad (11) \end{aligned}$$

or, since

$$\int_{-\infty}^0 e^{2ik\zeta^2} d\zeta = \frac{1}{2}\sqrt{\frac{\pi i}{2k}} \dots \dots \dots (12)$$

$$\phi = \sqrt{\frac{2k}{\pi i}} \left\{ \int_{-\infty}^{\omega_1} e^{2ik\zeta^2} d\zeta \mp \int_{-\infty}^{\omega_2} e^{2ik\zeta^2} d\zeta \right\}. \quad (13)$$

Now

$$\left(\xi \cos \frac{\alpha}{2} + \eta \sin \frac{\alpha}{2}\right)^2 = \frac{1}{2}(r + x \cos \alpha + y \sin \alpha),$$

i. e. $\omega_1^2 = \frac{1}{2}r \cos^2 \frac{1}{2}(\theta - \alpha)$ where $x + iy = re^{i\theta}$;

and similarly

$$\omega_2^2 = \frac{1}{2}r \cos^2 \frac{1}{2}(\theta + \alpha).$$

Using these results and also writing $2k\xi^2 = u^2$, we get, finally

$$\phi = \sqrt{\frac{1}{\pi i}} \left\{ \int_0^{\sqrt{2kr} \cos \frac{1}{2}(\theta + \alpha)} e^{iu^2} du \mp \int_0^{\sqrt{2kr} \cos \frac{1}{2}(\theta - \alpha)} e^{iu^2} du \right\}, \quad (14)$$

giving the well-known solution for the diffraction of an harmonic wave train.

§ 4. To deal with the diffraction of a disturbance of arbitrary wave form, it will be convenient to transform the integrals so that the limits are constants. Using (12), we have

$$\sqrt{\frac{2k}{\pi i}} \int_0^{\omega_1} e^{2ik\xi^2} d\xi = \frac{4k}{i\pi} \int_0^{\omega_1} e^{2ik\xi^2} d\xi \int_0^\infty e^{2iku^2} du. \quad (15)$$

Now write $u = \xi \tan \psi$, and we get

$$\frac{4k}{i\pi} \int_0^{\omega_1} d\xi \cdot \int_0^{\frac{\pi}{2}} e^{2ik\xi^2 \sec^2 \psi} \xi \sec^2 \psi d\psi. \quad (\omega_1 + ve).. \quad (16)$$

Changing the order of integration, this becomes

$$\frac{4k}{\pi i} \int_0^{\frac{\pi}{2}} d\psi \int_0^{\omega_1} e^{2ik(\xi \sec \psi)^2} \cdot \frac{1}{2} d(\xi \sec \psi)^2 \quad (17)$$

$$= -\frac{1}{\pi} \int_0^{\frac{\pi}{2}} (e^{2ik\omega_1^2 \sec^2 \psi} - 1) d\psi \quad (18)$$

$$= \frac{1}{2} - \frac{1}{\pi} \int_0^{\frac{\pi}{2}} e^{2ik\omega_1^2 \sec^2 \psi} d\psi. \quad (19)$$

If ω_1 is negative, the upper limit of integration becomes $-\frac{\pi}{2}$, which is equivalent to changing the sign throughout (16)-(19). After this is applied to (14) the solution

becomes discontinuous in form (though, of course, continuous in value) as we cross the lines $\omega_1=0$, $\omega_2=0$; *i. e.*, the lines $\theta=\pi+\alpha$, $\theta=\pi-\alpha$. These lines, with the diffracting plane, divide space into three regions, A, B, and C (fig. 2).

Fig. 2.

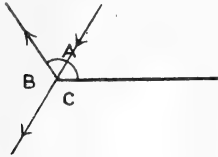

A, ω_1 and ω_2 both positive.
 B, ω_1 positive, ω_2 negative.
 C, ω_1 and ω_2 both negative.

§ 5. Now for an arbitrary incident wave we may write

$$\begin{aligned} \phi_i &= f(\beta) \\ &= \frac{1}{\pi} \int_{-\infty}^{\infty} f(\lambda) d\lambda \int_0^{\infty} e^{-ik(\beta-\lambda)} dk, \quad \dots \quad (20) \end{aligned}$$

provided the form of f is such that Fourier's Double Integral may be applied. The solution for the region A then becomes

$$\begin{aligned} \phi &= \frac{1}{\pi} \int_{-\infty}^{\infty} f(\lambda) d\lambda \int_0^{\infty} e^{-ik(\beta-\lambda)} \left\{ 1 - \frac{1}{\pi} \int_0^{\frac{\pi}{2}} e^{2ik\omega_1^2 \sec^2 \psi} d\psi \right\} dk \\ &\quad \mp \text{similar term in } \gamma \text{ and } \omega_2 \quad \dots \quad (21) \\ &= f(\beta) - \frac{1}{\pi^2} \int_0^{\frac{\pi}{2}} d\psi \int_{-\infty}^{\infty} f(\lambda) d\lambda \int_0^{\infty} e^{-ik(\beta-2\omega_1^2 \sec^2 \psi-\lambda)} dk \mp \dots \\ &= f(\beta) - \frac{1}{\pi} \int_0^{\frac{\pi}{2}} f(\beta-2\omega_1^2 \sec^2 \psi) d\psi \\ &\quad \mp f(\gamma) \left\{ -\frac{1}{\pi} \int_0^{\frac{\pi}{2}} f(\gamma-2\omega_1^2 \sec^2 \psi) d\psi \right\} \\ &= f(\beta) - g(\beta, \omega_1) \mp \{ f(\gamma) - g(\gamma, \omega_2) \}. \quad \dots \quad (22a) \end{aligned}$$

Similarly for region B,

$$\phi = f(\beta) - g(\beta, \omega_1) \mp g(\gamma, \omega_2); \quad \dots \quad (22b)$$

and for C,

$$\phi = g(\beta, \omega_1) \mp g(\gamma, \omega_2). \quad \dots \quad (22c)$$

The extension of the method and results to the case where the incident waves travel in a direction not perpendicular to the diffracting edge is easy.

LXVIII. *On the Mathematical Relations of the Magnetic Field.*

By G. H. LIVENS*.

IT has already † been noticed that the usual conception of the mechanical relations of the magnetic field, which is based on the assumption that the magnetic force is the fundamental vector, is somewhat misleading, if not entirely erroneous, and that in order to obtain a more consistent theory of these relations it is necessary to invert the usual order of things and take the magnetic induction as the fundamental force vector and the magnetic force as the induced vector. The object of the present note is to present in a concise form the results obtained by following through the usual arguments but starting with the more consistent fundamental conception.

In all physical theories it is usual to describe the relation between the inducing force and the induced effect by saying that the latter is an explicit function of the former. The inversion of such a description, which would give the inducing force as an explicit function of the induced effect, may not necessarily be incorrect, but it is at least inexpedient, as it is very liable, as in the present case, to lead to a serious misapprehension of the physical processes involved.

The mathematical relations of the magnetic field are always expressed in terms of three vectors: (i.) the *magnetic force* H , which is defined at any point of the body as the vectorial ratio to a small magnetic pole of the force on it, if placed there; (ii.) the *magnetic polarization intensity* I , which is the effective resultant bi-polar moment per unit volume of the medium at each place; and (iii.) the *magnetic induction vector* B , which in the elementary theory is best regarded as a composite vector induced by the force H , and such that

$$B = H + 4\pi I.$$

In the more consistent form of these relations the magnetic induction B is taken as the fundamental force vector and the magnetic force H as the induced vector, and then it is better to write

$$H = B - 4\pi I.$$

* Communicated by the Author.

† The complete development of the usual argument, with complete references, will be found in my book 'The Theory of Electricity' (C. U. Press, 1918).

It appears, then, that the vector H is in reality the mechanically effective part of the total magnetic force from which the local part in the polarization has been rejected, and it will therefore be derived from a potential under the usual appropriate conditions.

If the magnetization I is partly rigid (I_0) and partly induced (I_i) by the total force B , and if the induction follows a linear isotropic law, we should write

$$I_i = \kappa B;$$

and then

$$H = \mu B - 4\pi I_0,$$

wherein

$$\mu = 1 - 4\pi\kappa.$$

The new "permeability" coefficient μ here introduced, which expresses the permeability of the medium to mechanically effective magnetic force, is practically equivalent to the reciprocal of the ordinary permeability, and it is actually equal to this reciprocal when there is no permanent magnetism in the medium concerned*. This inversion will naturally lead to a revision of our physical ideas on magnetic induction; for it is now the induction of mechanical and not electromotive force that is under review.

In paramagnetic media κ is positive and less than $\frac{1}{4}\pi$, so that $\mu < 1$, and it is very small for the strongly ferromagnetic media near their saturation point. Free space is thus the most permeable paramagnetic substance, and the ferromagnetic media are almost impermeable. In diamagnetic media κ is negative, so that $\mu > 1$; so that here the permeability is still larger than it is in free space.

Let us pursue these relations further. The energy required to establish the permanent polarity of intensity I_0 at each point of space is

$$-\int dv \int^{I_0} (B dI_0),$$

the volume integral being extended throughout all space. The usual argument proves that in the statical case

$$-\int dv \int^{I_0} (B dI_0) = -\frac{1}{8\pi} \int B^2 dv + \int dv \int^{I_i} (B dI).$$

* The fact that the relation between the permeability as usually defined and that here employed is a function of the permanent magnetism must not be regarded as detrimental to the present suggestion. It may be due entirely to the older definition.

The second term on the right represents the internal elastic energy stored in the media on account of the magnetic polarity induced in them. The first part therefore represents the true magnetic potential energy of the field, and on a tentative theory we could regard it as distributed throughout the field with the density

$$-\frac{1}{8\pi} B^2$$

at any place. In the case of the linear isotropic law of induction, we have

$$H = \mu B - 4\pi I_0, \quad I_i = \kappa B;$$

so that

$$\delta I_i = \kappa \delta B,$$

and thus

$$\int^{I_i} (B dI_i) = \frac{\kappa B^2}{2}.$$

The total work done in the field is thus

$$\begin{aligned} \int dv \left[-\frac{B^2}{8\pi} + \frac{\kappa B^2}{2} \right] \\ = -\int \frac{\mu B^2}{8\pi} dv. \end{aligned}$$

These relations are somewhat simpler than those obtained on the only consistent form of the older theory, as the permeability is again restored to the numerator of the expression for the energy and in addition the unknown local terms are entirely absent.

When the field is static and the magnetic force proper possesses a potential function, the characteristic equation satisfied by this function is slightly different from that usually given. The induction vector B is always circuital, so that

$$\operatorname{div} B = \frac{\partial B_x}{\partial x} + \frac{\partial B_y}{\partial y} + \frac{\partial B_z}{\partial z} = 0,$$

and when the mechanical force H is derived from the potential ϕ we have

$$B = -\operatorname{grad} \phi + 4\pi I,$$

and, further, if the polarization is induced according to a linear isotropic law,

$$\mu B = -\text{grad } \phi + 4\pi I_0.$$

Thus finally,

$$\text{div} \left(\frac{1}{\mu} \text{grad } \phi \right) = \frac{4\pi \text{div } I_0}{\mu}$$

is the characteristic equation satisfied by the potential ϕ . In homogeneous media this is equivalent to

$$\nabla^2 \phi = 4\pi \text{div } I_0.$$

The surface condition at a bounding interface, corresponding to this equation, involves the continuity of

$$B_n = \frac{1}{\mu} \left(-\frac{\partial \phi}{\partial n} + 4\pi I_{0n} \right).$$

It used to be assumed that a complete analogy exists between the electrostatic and magnetostatic fields, the electric force, complete electric displacement, and electric polarization corresponding to the magnetic force, magnetic induction, and polarization respectively; but it has already been pointed out that no such complete analogy exists. With the suggested modification in the conception of the permeability the analogy again presents itself as a possibility, but it is by no means perfect, although it is more complete than is otherwise possible. There is, of course, no reason why the two sets of relations should be analogous, as the two cases are quite distinct, and the similarity in the expressions for the energy is obtained only when the one is treated as potential energy and the other as kinetic energy. From another point of view it appears that a most unfortunate mistake has been committed in starting with magnetism in a statical theory with a potential function. The more correct procedure is to begin with the magnetic induction as the true æthereal magnetic force and then to separate out from this vector the mechanically effective part, the magnetic force proper, which is derived from a potential function under the appropriate circumstances. By proceeding in the other way we have been led to assume, among other things already indicated in sufficient detail, that the magnetic force is the proper vector to use in such expressions as the complete electromagnetic force on a moving charge element, and when we have then found that in ferromagnetic media

such phenomena as the Hall effect or the various magneto-optical effects turn out to be always proportional not to the magnetic force but to the induction (or polarization, the two are practically the same in such cases), we have concluded that the behaviour of such media in this connexion is anomalous when, as a matter of fact, it is perfectly regular and provides one of the most powerful arguments in favour of our present contention.

Finally, we may notice the way in which the present permeability coefficient μ enters into the fundamental equation for wave propagation in the electromagnetic field. The fundamental equations in such cases are :

$$-\frac{1}{c} \frac{dB}{dt} = \text{curl } \mathbf{E}, \quad \frac{1}{c} \frac{dD}{dt} = \text{curl } \mathbf{H},$$

where

$$\mathbf{H} = \mu \mathbf{B}, \quad \mathbf{D} = \epsilon \mathbf{E}.$$

These lead in the usual way to the wave equation

$$\nabla^2 \phi = \frac{\epsilon}{\mu c^2} \frac{d^2 \phi}{dt^2},$$

which is satisfied by each component of the two vectors defining the field. The velocity of propagation is now

$$c \sqrt{\frac{\mu}{\epsilon}},$$

so that the magnetic permeability acts counter to the dielectric capacity, an increase in the one being negated by a corresponding increase in the other. But we must remember that the larger values of μ correspond to free space or diamagnetic media and that a "strongly magnetic" medium in the ordinary sense has a small permeability coefficient according to the present definition—or in other words, in strongly magnetic media the mechanical effectiveness of the complete force (the induction) is practically destroyed by the induced polarization which produces a counterbalancing local force.

The University, Manchester,
Jan. 20th, 1920.

LXIX. *On the Cadmium-Vapour Arc Lamp.*

To the Editors of the Philosophical Magazine.

GENTLEMEN,—

IN the March number of the *Philosophical Magazine* Mr. F. Bates contributes a paper on a new cadmium-vapour arc lamp, in which a similar lamp described by me about four years ago (*Proc. Phys. Soc.* xxviii. p. 94, 1916) is subjected to adverse criticism. It is stated that “the impurities introduced into the lamp” by my method of filling “effectively prevent obtaining a relatively pure intense cadmium spectrum.” It is not clear what is meant by this statement. The only impurity which I suggest introducing is zirconia, and zirconia sufficiently pure not to affect the spectrum of a cadmium-vapour arc is neither difficult to obtain nor to prepare. If the impurities are “introduced” in the process of filtering the metal in a vacuum, the fault obviously lies with the operator and not with the method. If, however, what is meant, is that metallic impurities such as zinc are not removed, this is obviously true, but holds also for the method of distillation recommended by Bates. The only satisfactory method of avoiding such impurities is to start from pure cadmium.

It is further stated that the zirconia does not sufficiently prevent adhesion of the metal to the glass, and that “if the lamp does not crack upon the first solidification” . . . “upon cooling a second time the lamp was invariably cracked.” In reply to this, I must point out that I do not remember a single case in which a lamp which I have filled myself has failed from this cause. I have also obtained evidence from two independent users of my lamps. One user states “I have had one of your lamps in continuous use since 9/6/16 . . . It is still working,—it has been in very frequent use, upon some occasions for 2 or 3 hours on end; the glass has now become somewhat opaque to the shorter wave-length radiation. Other lamps that we have used have not had the same length of life as the one I have used myself, but the breakdowns have not been due to the cause stated by Mr. Bates.”

The second user states that his lamp has been in use for about three years. “It has been heated up at least 500 times, and has burnt for over 600 hours.”

It is obviously not possible for me to state positively what were the reasons for Mr. Bates’s failures. Insufficient thickness of the quartz-glass or too coarse zirconia might be

suggested, but the balance of internal evidence in the paper points to faulty pumping as the cause. In filling lamps on a Toepler pump, I always leave the lamp evacuated at the pump in connexion with a large P_2O_5 tube for at least 24 hours before running in the metal in order to be sure of the removal of water vapour. I also usually cast the cadmium into sticks by suction into a heated glass tube fitted with a tap in order to be sure of the absence of blow-holes. The process of filtration, if properly carried out, is quite sufficient to free the molten metal from solid extraneous matter such as oxide, and I should certainly have considered the operation faultily performed if I had ever noticed traces of oxide in the lamp such as Mr. Bates reports he occasionally observes. The peeling off of "thin sections of the quartz from the walls," reported by Mr. Bates, certainly points to the formation of a cadmium-glass due to oxide as the result of water vapour, and not to the action of adhering metal.

I am, Gentlemen,

The Sir John Cass Technical
Institute, London.
March 20th, 1920.

Yours faithfully,

HENRY J. S. SAND.

LXX. *Mass, Energy, and Radiation.*

By J. J. THOMSON, O.M., P.R.S.*

THE object of this paper is to endeavour to supply a method of representing in terms of physical conceptions the processes occurring in physical phenomena. It is an attempt to help those who like to supplement a purely analytical treatment of physical problems by one which enables them to visualize physical processes as the working of a model; who like in short to reason by means of images as well as by symbols.

The ideas on which the method is based were suggested by the consideration, from the electrical point of view, of the origin of the mass of an electron. From this point of view this mass is distributed throughout the region surrounding the electron, and for an electron at rest the mass per unit volume at any point in this region is proportional to the square of the electric force at the point. The electrostatic potential energy per unit volume at this point is also proportional to the square of the electric force and is thus proportional to the mass. In fact (see 'Electricity and Matter,' J. J. Thomson, Chap. 2) the electrostatic potential

* Communicated by the Author.

energy is equal to the kinetic energy which the mass would possess if it moved with the velocity of light.

This result suggests that the potential energy in the electrostatic field is really the kinetic energy possessed by the mass which is distributed throughout the field, the mass being regarded as an aggregate of equal particles each one of which moves with the velocity of light. In a stationary electric field we may suppose that these particles revolve with this velocity round the lines of electric force, much as the electrons from a hot wire can be made to revolve, though at a slower speed, round lines of magnetic force.

It seems natural to generalize this result and to suppose that all mass, that of atoms as well as that of electrons, is distributed through space with a density determined by the electric field at the place where the mass is supposed to exist; and that energy of every kind, kinetic, potential, thermal, chemical or radiant, is of one and the same type, being the kinetic energy possessed by the particles which are supposed to constitute mass, these it is assumed always move with the velocity of light.

On this view there is no such thing as the *transformation* of energy, if by that we mean a discontinuous change from something of one kind into something of another; on our view the transformation of energy is merely the flow of the mass particles from one place to another. Thus for example, on this view when a body gains kinetic energy, it is not because any of its mass particles are moving faster; it is because the mass of the body has been increased and the increase in the mass implies a proportional increase in the energy.

It will perhaps make it clearer if we follow out in detail this process in a special case—we will take that of a moving electron. When an electron is moving relatively to the bodies around it, the lines of electric force which start from it are no longer uniformly distributed in all directions, those running in directions at right angles to the direction of motion of the electron get more concentrated, and those running parallel to this direction more diffuse. The total number of lines starting from the electron is unaltered by the motion and depends only upon the charge on the electron. Since the mass per unit volume at any place in the neighbourhood of the electron is proportional to the square of the number of lines of force passing through unit area at that place, the amount of mass between two spheres with their centres at the electron and whose radii differ by unity, will be proportional to $\int N^2 dS$, where dS is an element of the area

of surface of one of the spheres, and N the number of lines of force passing through unit area of the sphere. Since the charge is given, $\int N dS$ is fixed, and when this is so, $\int N^2 dS$ will be least when N is uniformly distributed over S , and for other cases the excess over the minimum value will increase with the amount by which the lines of force are concentrated in definite directions. The greater the velocity of the electron the greater is this concentration and therefore the greater the value of $\int N^2 dS$, *i. e.* the greater the value of the mass in the region close to the electron. Thus the moving electron has more mass in its immediate neighbourhood than an electron at rest, and as each unit of mass possesses, since the mass is moving with the velocity of light, a definite amount of energy, the energy of the moving electron will be greater than that of an electron at rest. This increase in energy is what is usually called the Kinetic Energy of the moving electron. It is necessary to say a few words about the definition and measurement of kinetic energy. When, as in ordinary dynamics, the kinetic energy of a body is defined by the expression $\frac{1}{2}mv^2$, it depends essentially upon the axes with respect to which the velocity is measured, the kinetic energy of the same body may be increasing when measured with reference to one set of axes and decreasing when measured with reference to another. The *changes*, however, of the total kinetic energy in a self-contained system, *i. e.* one which is not acted upon by any external forces, will, if action and reaction are equal and opposite, be independent of the axes used. What may be called the localization of energy, *i. e.* the assignment of a certain amount of energy to each member of a dynamical system, is a problem which, as far as rigid dynamics goes, has an unlimited number of solutions; any one of these solutions will give the same changes in the configuration of the system as any other, so that the localization of energy could not be deduced without ambiguity from observations of the configuration of the system.

On the method considered in this paper, the energy associated with an electron, for example, could be determined independently of any axes of reference if we had the power of counting the individual mass particles in its vicinity. We know, however, of no physical phenomenon which will enable us to do this, all that with our present knowledge of physics we are able to do is to compare the number of mass particles in one region with that in another, and this will

make the measurement of the mass of an electron, for example, depend upon the position of our measuring instruments. We may illustrate this point in the following way. Suppose we have a region A in which all the atoms and electrons were initially at rest relatively to each other. Now suppose that under electrostatic attraction an electron gets set in motion. From our point of view this means that some of the mass particles which initially were remote from the electron have come much closer to it; this will produce an increase in its mass, and from the equations of electro-dynamics we can calculate the ratio of the increased mass to the mass of the electron when it started from rest; we can also, even if every constituent atom or electron of the system gets set in motion under the electrostatic attraction and the mass of each is in consequence increased, calculate the ratio of the increased mass of each constituent to its original mass.

Suppose, however, that the whole region A gets set in motion as a rigid body by the action of an external system B; while the velocity of A is increasing the mass particles will be streaming into it, and while this is going on it is possible that the relative masses of the constituents of A may be affected. But when the velocity of A has become steady and there is no longer any influx of mass particles into it from the outside, the particles which have come into it while this state was being reached will distribute themselves so that the number of new particles in any region is proportional to the number that were present before the influx. Thus the relative masses of two constituents of A, say an electron and an atom, will be unaltered. Thus an observer in A will be unable to detect any effect due to a uniform motion of translation of this region, for though the mass of one of the constituents, as measured by the number of mass particles associated with it, may be altered, the mass of the unit by which that of the constituents is measured will be altered in the same proportion, so that the alteration will not be detected. The argument is the same as that which applies to any changes which the motion may produce in the shape or size of the constituents of the region A; these escape detection by an observer in A because his units are altered in the same proportion as the quantities measured. If, however, we had any method of counting the mass particles within the region A, an observer in this region ought to be able to detect an effect due to changes in the velocity of translation.

Again, if an observer in a region C which did not

participate in the motion of A had the means of comparing the mass of an electron in his region with that of one in A, he would find that the ratio depended on the velocity of translation of A.

Following the ideas suggested by these illustrations we get what I think is a consistent scheme for visualizing physical processes, if we assume the existence :—

1. Of particles all of the same kind and with the same mass. These particles all move with the velocity of light. Since the mass particles are moving with the velocity of light they would on the Lorentzian transformation have this velocity whatever might be the axes to which their motion was referred. Any force on a particle due either to other particles or to the electric field is always at right angles to the direction of motion of the particle. Thus, though a particle may be deflected its velocity remains unaltered.

The mass of one of these particles must, as we shall see, be exceedingly small compared with that of an electron.

All mass, whether of electrons or atoms or radiant energy, arises from the presence of these particles, and inasmuch as each particle possesses an invariable amount of energy, wherever there is mass there is an amount of energy proportional to it.

The distribution of these particles and their movement from one place to another is determined by the distribution of the lines of electric force. For we assume that in addition to the mass particles we have in the universe :

2. Lines of electric force spreading through space. These lines may be closed or they may begin or end at definite points. These points are the seats of what we call electrical charges, the electron being at one end of a line of force and a unit of positive electricity at the other. Each electron and each unit of positive electricity forms the end of an invariable number of lines of electric force. The connexion between the distribution of the mass particles and the lines of force is given by the rule that the mass per unit volume at any point P is proportional to

$$\left\{ f^2 + g^2 + h^2 + \frac{1}{c^2} (\alpha^2 + \beta^2 + \gamma^2) \right\},$$

which is also proportional to the energy per unit volume. f, g, h are the number of lines of force passing through a unit area at P at right angles to the axes of x, y, z respectively, α, β, γ are the components of the magnetic force. c is the velocity of light through a vacuum.

We regard magnetic force as due to the motion of the lines of electric force past the observer who is measuring the magnetic force. The relation between the electric and magnetic force when all the lines of electric force at P are moving with the same velocity is given by the equations

$$\alpha = 4\pi(gw - hv) ; \beta = 4\pi(hu - fw) ; \gamma = 4\pi(fv - gu) ;$$

when u, v, w are the components of the velocity of the lines of electric force relative to axes fixed with reference to the observer of the magnetic force.

From this equation combined with the expressions for the energy per unit volume, we see that P, Q, R, the components of the momentum per unit volume at P are given by the equations

$$P = \frac{1}{4\pi}(Z\beta - Y\gamma) ; Q = \frac{1}{4\pi}(X\gamma - Z\alpha) ; R = \frac{1}{4\pi}(Y\alpha - X\beta) ;$$

where X, Y, Z are the components of the electric force.

We can also, by the principle of varying action, deduce from the expression for the value of the energy the Maxwellian expressions for the stresses in the electric and magnetic fields which reproduce the mechanical forces existing in those fields.

From the expression for the energy in the electric field, we see that the mass particles are concentrated in the places where the electric field is strongest. Thus when the electric charges are electrons or positively charged units of exceedingly small dimensions—when, in consequence, the electric force is exceedingly strong close to the charge—by far the greater part of the mass will be quite close to the charge. Thus, for example, if the radius of an electron is 10^{-13} cm., only one thousandth part of its mass will be at a distance from the electron greater than 10^{-10} cm. Thus, though the mass particles are present wherever there is an electric field an enormous majority of them cluster close round the electrons and positive charges.

The mass particles perform the functions both of æther and matter. They perform the function of matter by endowing the electrons and positive charges found in the atoms of the chemical elements with mass, and when they are moving through space and carrying energy with them with the velocity of light they are performing functions usually ascribed to the æther.

By themselves the particles are not the whole, either of matter or of æther, for lines of electric force are an integral part both of æther and matter. We only get matter when we

have lines of electric force anchored on to electrons or the units of positive electricity; we only get radiation when we have along with the mass particles, closed lines of electric force. The distribution and movement of the lines of electric force determine the distribution and movement of the mass particles.

Comparing the physical universe with a living organism we may regard the mass particles as the flesh, the lines of electric force as the nervous system. Mass and energy are contributed by the mass particles, but the distribution, localization, and movement of both mass and energy are determined by the lines of electric force.

The mass particles in a steady electrostatic field, though moving with the velocity of light, are constrained to follow closed paths round the lines of electric force. This produces a tension along the lines of electric force, and these are only prevented from breaking away by being anchored to the electrons and positive charges, and so being obliged to drag about with them wherever they may go the masses condensed about these charges.

In a steady electrostatic field all the lines of electric force have their ends either on electrons or positive charges, none of these lines form closed curves. When, however, the electric field is changing, either by the motion of the positive and negative charges or otherwise, the lines of electric force may get looped, and some of them may form closed curves. These closed curves are not anchored to electrical charges, there is nothing to prevent the mass particles from dragging them away; thus the mass particles will travel out through space with the velocity of light through a vacuum, dragging after them the closed lines of electric force. This, on the view we are considering, is the way in which radiation is supposed to originate. Since both the energy and mass are due to the mass particles, we see that, on this view, radiation involves a transference of mass proportional to the transference of energy. The speed with which the radiation travels is the speed of the mass particles, this speed is invariable and equal to the velocity of light through a vacuum: it is independent of the medium through which the particles are travelling; the velocity of light, however, depends upon the medium, and we have to show that an invariable velocity of the mass particles carrying the energy is consistent with the variation in the velocity of light with the medium through which it is travelling. When a wave of light passes through a refracting medium the electrons in the medium are set in vibration and give out secondary waves; the effect

of these secondary waves is to make the apparent velocity of the light through the medium depend upon the number of electrons in that medium, though all the constituents which make up the resultant wave travel with the velocity of light through a vacuum.

A detailed analytical investigation of this effect will be given in another paper, but the general principles on which the results depend may be illustrated by considering the special case of a pulse of electric force travelling through a slab of refracting matter bounded by planes at right angles to the direction of propagation of the pulse. Let us suppose that the electric force in the pulse is parallel to the axis of x and that the pulse is travelling parallel to z and bounded by two parallel planes at right angles to z . Let the thickness of the pulse be $2d$, let the electric force in the pulse before it strikes the slab be constant in the front half d and equal to X , while in the rear half it is also constant but equal to $-X$. Let us consider the effect produced by this pulse when it strikes the slab of electrons. When the force X strikes the electrons it will accelerate them, and in consequence they will emit secondary waves in which the electric force is in the opposite direction to X .

Fig. 1.

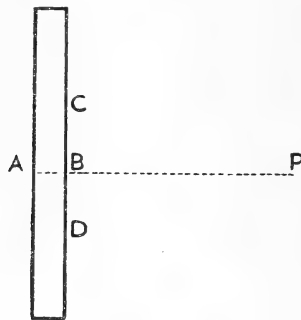

Let AB be the slab containing the electrons and suppose the front of the pulse has reached P ; the only secondary radiation which has had time to reach P is that coming from the electrons at B , the part of the slab nearest to P . When a little later a part of the pulse a little in the rear of the front reaches P , the secondary radiation carrying a negative X will have had time to come up from outlying places like C and D , and will diminish the electric field in this part of the pulse. Now consider what will happen when the

positive half of the pulse has just passed P and the negative half is just arriving. At first the secondaries which arrive at P will be those excited by the front and positive half of the pulse, and the force on them will be in the negative direction, *i. e.* in the same direction as that in the part of the primary pulse which is now arriving at P, and thus the secondaries will increase the magnitude of the electric force in the pulse. After a time the secondary radiation excited by the negative part of the pulse will begin to come up; the force on this will be in the positive direction, and will diminish the intensity of the force in the primary pulse. The secondary radiation from outlying regions will continue to arrive at P after the primary pulse has passed, so that the primary pulse will have developed a tail. Before passing through the slab the distribution of electric force in the pulse would be represented by a graph like α (fig. 2), while after passing through the slab it will be represented by β .

Fig. 2.

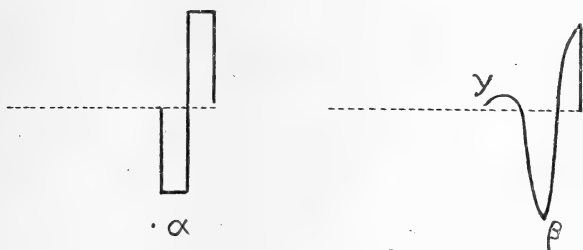

We see that the result of passing through the slab has been to diminish the energy in the front half of the pulse, to increase it in the rear half, and to develop a positive tail γ . Now let this modified pulse go through a second slab; the energy in the front half will be still further diminished, the energy in the rear half and in the tail γ will be increased, and another tail of negative force δ will be developed. This process will go on as the pulse passes through other slabs until the energy in the front part is reduced to insignificance and the second half of the pulse will be the active front; this will in its turn be worn down by the same process and the tail γ will take its place, this will be succeeded by the tail δ , and so on. In this way the virtual front of the pulse is continually falling behind the place which the pulse would have reached if it had not been passing through the slabs of electrons, and the amount by which it lags behind will depend on the density of the electrons

in the slab. Thus the velocity of the pulse through the medium containing the electrons will differ from that through empty space and will depend upon the nature of the medium, in spite of the fact that all the radiations which make up the pulse travel with the velocity of light through a vacuum. Hence we see that the constancy of the velocity of the mass particles which carry the energy and mass of light is consistent with light travelling with quite a different velocity when passing through a refracting medium.

On the view we are discussing the radiation as it were carries its æther along with it. The medium which carries the radiation is not something uniformly distributed through space but fragments torn from matter, carrying along with them lines of electric force as an integral part of the radiation.

Though this theory of radiation may be described as an emission one, yet since the velocity of the mass particles is invariable the velocity of light will not be affected by the motion of the source, or when the light is reflected, by the speed of rotation of the mirror. Experiments recently made by Majorana are in accordance with this result.

Since on the view we are discussing energy is made up of a number of equal units, the transference of energy from one body to another must take place by definite steps, and no transference is possible unless the amount to be transferred exceeds a finite amount. This involves that the dynamics of processes involving very small transfereces of energy must differ fundamentally from ordinary dynamics.

We are not yet in the position to calculate the mass of one of these mass particles, but it is certain that it must be an exceedingly small fraction of that of an electron. For the energy of an electron is about 10^{-7} erg, which can be represented by the fall of the atomic charge of electricity through about 6×10^4 volts. Now the average energy of a molecule of a gas at 0° C. corresponds to the fall of the atomic charge through a potential difference of about $\frac{1}{30}$ of a volt. Hence if the mass of a mass particle is ω times the mass of an electron, the smallest amount of energy which could be transferred from one body to another would be about $1.8 \times 10^6 \times \omega$ times the mean energy of a gas molecule at the temperature of 0° C. Now suppose a gas is raised from absolute zero to a higher temperature, if each molecule of the gas receives the minimum amount of energy possible, the temperature of the gas would be raised to

$$1.8 \times 10^6 \times \omega \times 273 \text{ absolute;}$$

when the temperature is less than this only a fraction of the molecules will acquire any additional energy from the rise in temperature. When a large number of molecules have acquired no additional energy at all, it would seem improbable that any large number should have acquired the extra energy corresponding to additional degrees of freedom, for example, for a diatomic molecule to have acquired the energy due to its rotation round the centre of mass as well as that corresponding to energy of translation, but unless it did this the specific heats of diatomic gases at temperatures less than $1.8 \times 10^6 \times \omega \times 273$ absolute, would approximate to those of monatomic gases; this consideration shows that ω must be less than 10^{-8} . Again, we know from Michelson's experiments on the green line of mercury that the source of this line can give out more than 400,000 vibrations without abrupt change of phase; from Planck's rule, the energy in this radiation is that due to the fall of the atomic charge through a potential difference of 2.5 volts, *i. e.* is about $1/(2.4 \times 10^4)$ of the energy of an electron. If there is only one mass particle per wave-length of the radiation, there will be more than 4×10^5 mass particles in this amount of energy, so that the energy of one of these particles will be less than $1/(2.4 \times 10^4 \times 4 \times 10^5)$ of that of any electron. Since the ratio of the masses is the same as that of the energies we conclude that at least 10^{10} and probably many more mass particles are required to supply the mass of an electron.

If energy is indivisible beyond a certain limit, then the inverse square law of electrical attraction cannot hold at all distances. For when this law holds, the energy outside a sphere of radius r with its centre at an electron, bears to the energy of the electron the ratio a/r , where a is the radius of the electron; hence if a/r is less than ω the energy outside the sphere will be less than the energy possessed by one mass particle. Thus since the particles are indivisible there would be no particles and no force when r is greater than a/ω , so that the law of electric force cannot be the inverse square law over more than a certain finite distance.

LXXI. *On the β -Recoil.* By ANIELA MUSZKAT,
Radiological Laboratory, Warsaw *.

THE experimental evidence concerning the β -recoil radiation, as resulting from former publications on this subject, is in some points insufficient. Makower † and Russ established the existence of the phenomenon, but there are some doubts concerning the exceedingly small recoil efficiency observed, and the impurity of the recoil product.

Makower and Russ have tried to explain their results by supposing that the active deposit forms agglomerations on the surface of the activated bodies, these agglomerations exercising a strong absorption on the recoiling atoms. This hypothesis is not improbable in itself. The mechanism of the deposition of active matter may resemble the condensation of vapour on a cold surface, in which case there are small droplets formed instead of an uniform layer. However, if the quoted authors are right, then the deficiency ought to depend upon the mean surface density, being greater for the less active surfaces. As this does not occur, one must search for another explanation.

Mr. Wertenstein suggested to me that the absorption of the recoiling atoms may be due to two different causes: (1) an adsorption of a gas layer on the activated surface, the electric transport of the gaseous ions during the activation contributing greatly to this adsorption; (2) the penetration of the active deposit by diffusion into the mass of the activated body. The only possible way of eliminating these presumed causes of error seems to be in obtaining a layer of active matter by distillation *in vacuo*, and examining the recoil from this layer immediately after the distillation. In the present work I adopted a method based on this idea.

A platinum wire, made active with RaB + C in the usual way, was placed very near the surface to be coated with distilled RaB. By the use of a ground-glass piece, this surface ‡ could rotate through 180° and in this way direct its recoil stream on a receiver. The apparatus I used at first was very simple, but an unexpected difficulty compelled me to make it far more complicated. It was hoped that the "cold disk" would act as a perfect screen to the distilling matter, the atoms of RaB travelling *in vacuo* on straight lines and being retained—as I thought—by the disk, after they

* Communicated by Dr. L. Silberstein.

† Phil. Mag. vol. xix. p. 100 (1910).

‡ Called in this paper for the sake of brevity, "the cold disk."

had struck it. Experience showed, however, that the whole apparatus, in spite of the high vacuum obtained, became filled with the distilling RaB + C, which was present probably in a gaseous form, and the receiver was contaminated with active matter before being exposed to the recoil stream. Diaphragms of different forms proved useless. This shows that at ordinary temperature a metallic surface does not possess the faculty of retaining an atom of RaB or RaC after a single shock. Similar facts were observed by Knudsen * in the case of the condensation of mercury and other metallic vapours on glass walls. No doubt, the results could be improved by cooling the surface to a very low temperature, but it would be a very troublesome operation, and so I tried to avoid this difficulty by disposing the receiver in a part of the vessel that could be separated hermetically from the other parts of the apparatus during the distillation, and then set in communication with them during the recoil experiment.

For this purpose a device was used similar to that adopted by Mr. Wertenstein for his exposure vessel †. The part of the apparatus A (*cf.* fig.) containing the active wire and the cold disk had at its top a support on which reposed the bottom of the little cylindric vessel B, containing the receiver D. The two vessels had concentric openings of the same diameter (12 mm.), so that by displacing the upper vessel a perfect separation of A and B was obtained. The "cold disk" M was fixed on a cylinder rotating on a horizontal axis by means of the ground-cock S_2 . The wire Pt, 0.1 mm. thick, was fixed on a ground-cock S_1 , which also fitted well in the exposure vessel. It was stretched in the form of a loop between two thick platinum wires which passed through an ebonite plug. These wires enabled me to bring the thin wire to the high potential required for activating it in the exposure vessel and also to heat it by an electric current for distillation purposes, when in the recoil apparatus.

The tube r connected the apparatus to the Gaede molecular pump and to a thermic manometer, described by Mr. Wertenstein ‡.

The method of conducting the experiment consisted in heating at first thoroughly the wire *in vacuo* in order to clean the platinum and to remove the occluded gases. The wire was then made active by placing it for about $1\frac{1}{2}$ hours in the exposing vessel, containing several millicuries of radium

* *Ann. d. Physik*, 1916, 1. p. 472.

† L. Wertenstein, Thèse, Paris, 1913.

‡ L. Wertenstein, "Sur quelques procédés de la technique du vide." *C. R. de la Société Scientifique de Varsovie*, 1917.

emanation. After the activation, the wire was heated in a special apparatus *in vacuo* to remove the occluded emanation. The γ -activity of the wire was then measured. Finally, after RaA had died off, the wire was introduced into the recoil vessel.

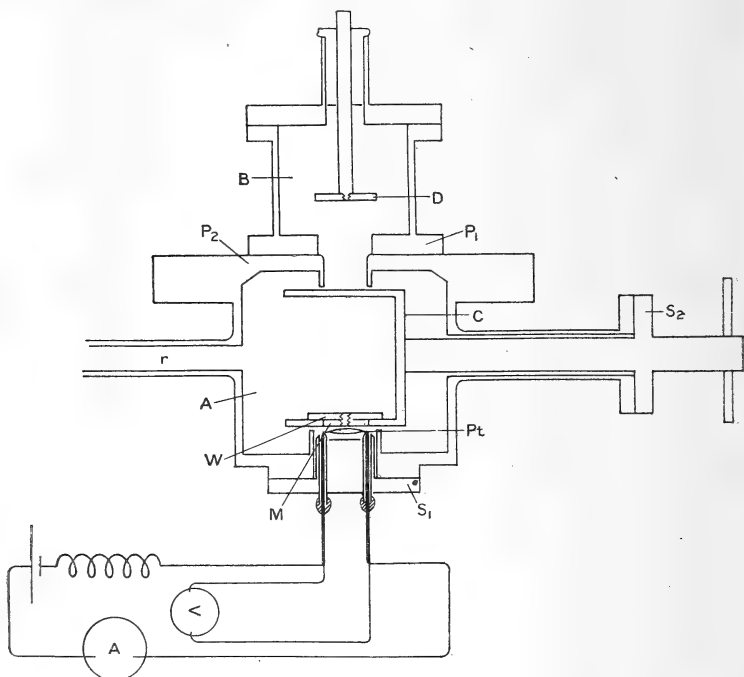

the upper part occupying the central position. The pump was set in movement, until the highest obtainable vacuum (about 0.6 dyne/cm.^2) was reached. At this moment the upper vessel was displaced and an electric current sent through the platinum wire, heating it to a mean temperature of 426°C. , as measured by the variation of its resistance, controlled by means of an amper- and voltmeter. The current lasted for 1 minute, the cold disk (10 mm. in diameter) being maintained 1 mm. above the wire. It is worthy of notice that the temperature of the wire plays an important rôle in the subsequent recoil phenomena. If it is too low, the quantity of distilled matter is too small. On the other hand, it is useless to raise the temperature considerably above 426° , for although the disk B becomes more active, the efficiency of the recoil is diminished and falls to a very low value when the temperature is above 800° . This shows, as

I think, that even at these temperatures a slight volatilization of platinum takes place, being quite sufficient to cover the RaB atoms with an impenetrable layer.

After the current is cut off, the disk M is turned to the receiver by a rotation of 180° and the upper vessel is placed in the central position. The exposure to the recoil lasts for five minutes. The air is then introduced into the apparatus and the two disks M and D are removed. Their activities are measured, the measurements being continued at regular intervals during an hour. From the analysis of the disintegration curves I obtained the amount of RaB present on the cold disk at the beginning of the recoil experiment and the quantity of RaC on the receiver at the end of it. If B be the former quantity, C the latter*, ω the solid angle subtended by the receiver (equal to $0.0336 \cdot 4\pi$), then the efficiency E is given by

$$E = \frac{4\pi}{\omega} \cdot \frac{C}{B} \cdot \frac{c-b}{b(e^{-5b} - e^{-5c})}.$$

It must be noticed that I obtained in all cases on the receiver almost pure RaC. The cold disk contained RaB and RaC in proportions approaching those of the radioactive equilibrium between the two products, its activity amounted only to a small percentage of the activity of the active wire, thus showing the great dispersion, already mentioned, of the distilling matter.

I found that the efficiency depended on the nature of the cold disk. It was equal to 0.2 for an ordinary brass disk, to 0.3 for the same disk after it was thoroughly polished, to 0.4 for an aluminium disk, and to 0.5 for a platinum one. We see that in all cases the efficiency is of the order of unity, *i. e.*, that the conditions of my work are far more favourable to the study of the β -recoil than the conditions used in previous work on this subject. The rôle of the nature of the surface can easily be understood if one considers that the main obstacle to the expulsion of RaC is due to the penetration of the radioactive matter into the metal and probably also to chemical actions between this matter and the substance of the disk. That RaB penetrates into the metal can be proved by the fact that the efficiency of the recoil diminishes with time. In one case, when the recoil experiment was conducted 20 minutes after the distillation, the efficiency was reduced to half its value.

The electric field, when established between the disk M

* The quantities calculated from the curves are not B and C, but, as usual, Bb and Cc.

and the receiver, does not influence the phenomenon, proving that the β -recoil atoms are uncharged, as was already stated by Makower and Russ.

It seems to result from my experiments that there is a limit to β -recoil efficiency, this limit being approximately equal to 0.5. The probable explanation of the existence of such a limit may be given by considering the thermal velocities of the expelled RaC atoms in connexion with their recoil velocity, as calculated from the mean velocity of the β -rays of RaB. If v_R be the recoil velocity, v_t the mean velocity of thermal agitation of RaC at ordinary temperature, then

$$v_R = 5 \cdot 10^4 \text{ cm./sec.}; \quad v_t = 1.64 \cdot 10^4 \text{ cm./sec.}; \quad v_R = 3v_t.$$

The two components being quite independent of one another, it results that the effective velocity of the recoiling atoms oscillates between largely differing limits, being respectively equal to $4v_t$ and $2v_t$. We can speak of the equivalent temperature of the recoiling RaC-atom, meaning by it a temperature at which this atom would possess a mean thermal velocity equal to its effective velocity. Taking 290° abs. as the temperature of the experiment, we find that the equivalent temperature oscillates between :

$$16.290^\circ \text{ abs.} = 4640^\circ \text{ abs. and } 4.290^\circ \text{ abs.} = 1160^\circ \text{ abs.} = 887^\circ \text{ C.}$$

The lower limit being of the same order of magnitude as the temperature of volatilization of radioactive matter, one can easily imagine that the corresponding kinetic energy may not be sufficient to remove the RaC from the "cold disk." We see in this way a reason for the β -recoil impulse being in some unfavourable cases not strong enough to tear off the radioactive matter from the surface of the activated body.

Warsaw, June 1919.

The Radiological Laboratory of the
Scientific Society of Warsaw.

LXXII. *Note on the X-ray Spectra of the Elements.* By
R. WHIDDINGTON, M.A., D.Sc., *Cavendish Professor of
Physics in the University of Leeds* *.

SOON after Barkla's discovery of the L series of characteristic X-radiations, I put forward an empirical formula of the type $v = C.w + D$ which approximately represented the K and L series of radiations of the elements †.

* Communicated by the Author.

† 'Nature,' Nov. 30th, 1911; see also Proc. Roy. Soc. 1912, vol. lxxxvi. ser. A, p. 378.

Since at that time methods of wave-length measurement had not been developed, it was suggested that the quality of X-rays should be defined by this formula in terms of the speed (v) of the electron carrying the same amount of energy as the X-ray under definition. These speeds had been measured for a number of elements between aluminium and silver, from which it had been concluded that for the K series $v = w \times 10^8$ cm./sec., and for the L series $v = \left(\frac{w}{2} - 25\right) 10^8$ cm./sec., where w = the atomic weight of the element.

With the advent of crystal spectrometry and the accurate measurement of a large number of the X-ray spectra, Moseley* in two well-known papers showed that atomic number was more fundamental than atomic weight and proposed the relation $\nu = A(N - b)^2$, where ν is the frequency of the characteristic radiation (strong α line in the K series, strong α line in the L series), N is the atomic number of the element, and A and b are the series constants.

It is one object of this note to point out that the relation $v = C.w + D$ becomes Moseley's relation if we put

$$w = 2N \dagger \quad \text{and} \quad \frac{1}{2}mv^2 = h\nu,$$

which is the usual quantum relation.

For then

$$v^2 = \frac{2h\nu}{m} = (2C.N + D)^2,$$

$$\text{or} \quad \nu = \frac{m}{2h} (2C.N + D)^2,$$

$$\nu = a(N + d)^2,$$

where $a = \frac{2mC^2}{h}$ and $d = \frac{D}{2C}$, which is Moseley's relation.

Reverting to $v = C.w + D$, which is now revived in the form $v = CN + D$, the following table shows the values of v for the K series α line from tungsten to sodium, approximately calculated from $\frac{1}{2}mv^2 = h\nu \ddagger$.

* Phil. Mag. 1913, vol. xxvi. p. 1024, and 1914, vol. xxvii. p. 712.

† See Bohr, Phil. Mag. 1913, vol. xxvi. p. 499.

‡ The values of λ were taken from Tables given by Uhler, Phys. Rev. vol. ix. No. 4 (1917).

TABLE I. (K series.)

Element.	N.	$\lambda \times 10^8$.	$v \times 10^{-8}$.	$2(N-2)$.	$v \times 10^{-8}$ * (determined experimentally).
W	74	0.210	145	144	—
Nd	60	0.333	115	116	—
Sn	50	0.489	95.1	96	—
Zr	40	0.791	75.0	76	—
Se	34	1.107	63.4	64	73.8
Zn	30	1.435	55.6	56	63.2
Cr	24	2.286	44.0	44	50.9
Ca	20	3.357	36.3	36	—
Na	11	11.951	18.5	18	—

It will be seen from columns 4 and 5 that $v = 2(N-2)10^8$ cm./sec. for these calculated values of v .

Column 6 gives the values of v determined experimentally for selenium, zinc, and chromium †. It appears that the experimental values of v in these three cases are about 16 per cent. greater than the calculated values—a result in general agreement with Webster's ‡ more recent experiments.

Table II. is a repeat of Table I. for the L series from U to As, the 6th column being omitted owing to lack of data.

TABLE II. (L series.)

Element.	N.	$\lambda \times 10^8$.	$v \times 10^{-8}$.	$(N-15)$.
U	92	0.720	78.4	77
Hg	80	1.049	65.0	65
Yb	70	1.474	54.9	55
Nd.....	60	2.167	45.3	45
Sn.....	50	3.381	36.2	35
Zn.....	40	5.851	27.5	25
As.....	33	9.419	20.7	18

It will be seen from a comparison of columns 4 and 5 that for the L series $v = (N-15)10^8$ cm./sec. very approximately. The agreement is not nearly so close as for the K series.

Summary.

The speed of electron (v) carrying the same energy as the α lines in the K and L spectra of the elements is shown to be fairly well represented by the formula $v = C.N + D$, where N is the atomic number of the element, and C and D are constants determined by the series.

For the K series $v = 2(N-2)10^8$ cm./sec.,
and for the L series $v = (N-15)10^8$ cm./sec.

* See Kaye's 'X-Rays,' p. 133, 3rd edition (1918).

† Whiddington, Proc. Roy. Soc. 1911.

‡ Webster, Phys. Rev. 1916, vol. vii. p. 612. It appears that this 16 per cent. represents the difference between the α and γ components.

LXXIII. *Notices respecting New Books.*

Catalysis in Theory and Practice. By ERIC K. RIDEAL, Ph.D., and HUGH S. TAYLOR, D.Sc. Pp. xv + 496. London: Macmillan and Co., Ltd., 1919. 17s. net.

THIS book comes in the fulness of time. Catalytic processes have played an important part in the development of chemical science for the last hundred years. The extent of the application of such processes in recent years is very remarkable.

It is a pity that no satisfactory explanation of this action is yet forthcoming. This is possibly, in part, owing to the wide scope of the term catalysis. Whenever a chemical change is accelerated (or the reverse) by the introduction of a foreign substance the process is spoken of as catalytic (positive or negative, as the case may be). Now, in the multifarious cases that arise, it is not likely that the process is identical in kind; hence a corresponding multiplicity of explanations is required. It is true that the authors attempt to restrict the field, and to lay down the requirement that the chemical composition of the catalytic agents is unchanged on completion of the reaction process. In some cases, however, of negative catalysis the retarding agents are not present at the beginning, and increase as time goes on; these hardly seem to fit in with the definition given. However, the definition covers what is denoted by the term positive catalysis very well.

The authors do not commit themselves to any one theory, but outline several theories, each of which has something to be said for it. Concerning the thoria-ceria mantle which is still very much a conundrum, no explicit reference is made to Rubens's theory that the poor general emissivity of thoria enables a high temperature to be reached, at which the selective luminous radiation of ceria is extremely high (though not higher than that of a black body at the aforesaid high temperature). If this is right, the mantle is not an example of catalysis at all.

Amongst the modern processes the hydrogenation of oils is of tremendous importance, due to the increase produced in our food-supply. Also during the war the necessity for ensuring a supply of nitrates for explosives rendered imperative the creation of a fresh supply: just as in Germany the same imperative necessity had presented itself before a war could be undertaken; and in both cases the utilization of the nitrogen from the air involved the use of catalytic processes. These the authors are specially competent to deal with.

We cannot here examine the book in detail. The writers deal in a masterly way with the problem. We conclude by quoting the final words of their own preface: "Will the catalytic agencies be found which shall accelerate the velocity of atomic decay and render available the enormous stores of intra-atomic energy? Such is the fitting problem for the years that lie ahead."

Ten British Physicists. By ALEXANDER MACFARLANE.

Chapman & Hall. Price 7s. 6d. net.

THE ten scientists whose lives are dealt with in the book before us

Phil. Mag. S. 6. Vol. 39. No. 234. June 1920. 2 Z

are: J. Clerk Maxwell, W. J. M. Rankine, P. G. Tait, Lord Kelvin, Charles Babbage, William Whewell, Sir George Gabriel Stokes, Sir George Biddell Airy, J. C. Adams, and Sir John Herschel. The list does not, of course, include some of the most distinguished physicists of the nineteenth century, which is the period referred to on the title-page, and of those admitted most people would, perhaps, scarcely count Whewell, Babbage, Adams, or even Herschel, though he carried out well-known experiments on fluorescence, as physicists. This is, however, a mere matter of title, and the lives of the thinkers just mentioned are by no means the least interesting in the volume. Babbage, in particular, has sunk into ill-deserved oblivion: although his unfortunate temperament prevented him turning to full advantage his boundless ingenuity and great mathematical powers, his work on calculating machines was fundamental and has been of the utmost value to his successors. Probably, too, our present notation in the calculus owes something for its establishment to Babbage's "Analytical Society," which advocated "the principles of pure *d*-ism in opposition to the *dot*-age of the University." Dr. Macfarlane's short and sympathetic study tells us something of a stormy life, which is interesting to most readers. In the account of Rankine we are reminded of the hypothesis of molecular vortices which the great engineer, so well-known for his work in thermodynamics, put forward with so much confidence, and of his poetical abilities. It is noteworthy that Whewell, Clerk Maxwell, and John Herschel were also accomplished versifiers. On the whole, these lines make very pleasant reading. They are, of course, short, and, being founded on lectures given to a mixed audience, do not devote much space to attempting to estimate in detail the value of the scientific achievements of the various men, or their precise place in scientific thought. The man who has read, for instance, Campbell's 'Life of Maxwell' will not find here anything new about that physicist. But the essays give a very readable impression of the life and personal character of the selected ten, and of the class of problems which they were engaged in solving. There is plenty of room for brief biographies of this kind, and the book should appeal to a large circle of readers.

LXXIV. *Proceedings of Learned Societies.*

GEOLOGICAL SOCIETY.

[Continued from p. 384.]

November 19th, 1919.—Mr. G. W. Lamplugh, F.R.S., President, in the Chair.

THE following communication was read:—

'The Pleistocene Deposits around Cambridge.' By Prof. John Edward Marr, Sc.D., F.R.S., V.P.G.S.

This paper deals with the deposits in the immediate vicinity of Cambridge, and contains new records of sections, fossils, and implements. It is pointed out that, owing to alternating periods of erosion and aggradation, relative height above sea-level is not a

trustworthy index of antiquity, and modifications of the classification proposed by W. Penning and A. J. Jukes-Browne are indicated.

The author suggests the following chronological sequence, in descending order:—

	<i>Feet.</i>
(1) Barnwell Station Beds.....	20
(2) Newer Downing Site Beds.....	35
(3) Newer Barnwell Village Beds.....	45
(4) Huntingdon Road Clays.....	70
(5) Observatory Beds.....	85
(6) <i>Corbicula</i> Gravels (Barnwell village, etc.) ...	30

The figures on the left give the approximate height above sea-level.

It is believed that Nos. 6 and 5 were formed during a period of aggradation, and 4-1 during one of subsequent erosion with minor aggradation; but it cannot be conclusively proved that 6 and 3 are of different ages, although the deposition of the beds 6 below those of series 3, where they occur together, and the occurrence of *Hippopotamus* and *Belgrandia marginata* with *Corbicula* suggest an early date for these *Corbicula*-bearing beds.

Taking the beds in the order of reputed age, the following observations are noted:—

Chellean implements have been found at low levels at Barnwell and Chesterton, and may belong to the beds 1. The Observatory Beds have yielded abundant implements of Chellean, Acheulean, and early Mousterian types, the last-named apparently in deposits later than those containing the two first-named. Unfortunately mollusca and mammalia are very rare in these beds. The Huntingdon Road Clays require much further work, as only poor exposures have hitherto been found, and it is not clear that they are newer than the Observatory Beds.

The beds referred to the Newer Barnwell Village Series contain abundant remains of the mammoth, woolly rhinoceros, and fairly numerous horse-bones. Implements associated with them suggest an Upper Palæolithic age.

The Newer Downing Site Beds have yielded a cold molluscan fauna. They are probably somewhat earlier than the Barnwell Station Series, which has furnished a similar molluscan fauna, and also an Arctic flora, the plants of which were identified by the late Mr. Clement Reid. Reindeer occurs in these beds.

The paper is chiefly a record of facts, but it is intended to be preliminary to a detailed survey of the Pleistocene deposits of the Great Ouse Basin, which are so important as throwing light upon the relationship of the Palæolithic beds to the glacial accumulations, and also to the marine beds of March and the Nar Valley.

Appendix I, on the Non-Marine Mollusca, is supplied by Alfred Santer Kennard, F.G.S. and B. Barham Woodward, F.L.S., F.G.S.

Lists are given of the non-marine mollusca from the various sections, with their degrees of frequency. These lists are based on examination of old collections and on a large amount of new material. Notes are appended on some of the species, and conclusions as to the ages of the Cambridge gravels are given, based on the molluscan evidence.

Appendix II, on the Implements, is supplied by Miles C. Burkitt, M.A.

INDEX to VOL. XXXIX.

- A**BERRATION, on Stokes's theory of, 161.
- Acoustical experiments, on a mechanical violin-player for, 535.
- Adeney (Prof. W. E.) on the rate of solution of atmospheric nitrogen and oxygen by water, 385.
- Æther, on the recent eclipse results and Stokes-Planck's, 161; on a possible structure for the, 170; on a fluid analogue for the, 651.
- Air, on the magnetic susceptibility of, 318; on the scattering of light by, 423.
- Alloys, on the effect of centrifuging certain, 376.
- Anderson (Prof. A.) on Fresnel's convection coefficient, 148; on the spheroidal electron, 175; on the advance of the perihelion of a planet and the path of a ray of light in the gravitational field of the sun, 626.
- Anemometer, on the hot-wire, 505.
- Arc lamp, on a cadmium vapour, 353, 678.
- Argon, on the mass-spectrum of, 620.
- Aston (Dr. F. W.) on the constitution of atmospheric neon, 449; on the mass spectra of chemical elements, 611.
- Baly (Prof. E. C. C.) on light absorption and fluorescence, 565.
- Basu (M. N.) on the equation of state, 456.
- Bates (F.) on a new cadmium vapour arc lamp, 353.
- Beams, on the buckling of deep, 194.
- Becker (H. G.) on the rate of solution of atmospheric nitrogen and oxygen by water, 385.
- Bell (E. T.) on parametric solutions for a fundamental equation in the general theory of relativity, 285.
- Beta-recoil, on the, 690.
- Bickley (W. G.) on the diffraction of waves by a semi-infinite screen with a straight edge, 668.
- Books, new:—Hunter's *The Earth's Axes and Triangulation*, 239; Jeans' *Problems of Cosmogony and Stellar Dynamics*, 377; Wood's *Researches in Physical Optics*, 379; Karpinski, Benedict, and Calhoun's *Unified Mathematics*, 380; Lamb's *Elementary Course of Infinitesimal Calculus*, 381; Whitehead's *Enquiry concerning the Principles of Natural Knowledge*, 629; Shaw's *Manual of Meteorology*, 631; Stewart's *Stereochemistry*, 632; Rideal and Taylor's *Catalysis in Theory and Practice*, 697; Macfarlane's *Ten British Physicists*, 697.
- Bragg (Prof. W. L.) on the crystalline structure of zinc oxide, 647.
- Buckling of deep beams, on the, 194.
- Cadmium vapour arc lamp, on a, 353, 678.
- Campbell (Dr. N.) on the adjustment of observations, 177.
- Carbon, on the excitation of the spectra of, by thermoelectronic currents, 241; on the mass-spectrum of, 619.
- dioxide, on the magnetic susceptibility of, 322; on the specific heat of, 551.
- Carrington (H.) on the buckling of deep beams, 220.
- Carslaw (Prof. H. S.) on Bromwich's method of solving problems in the conduction of heat, 603.
- Centrifuge, on the separation of lead into isotopes by the, 372; on the action of the, on certain alloys, 376.

- Charged particles, on the dynamical motions of, 537.
- Chemical constants, on the determination of, 1; on the significance of, 21.
- elements, on the mass-spectra of, 611.
- reactions, on the quantum theory and, 26.
- Chlorine, on the mass-spectrum of, 620.
- Coal-gas and air, on the radiation emitted in explosions of, 66, 84.
- Compton (A. H.) on radioactivity and the gravitational field, 659.
- Conduction of heat, on problems in the, 603.
- Contrasts, on the photographic rendering of, 151.
- Convection coefficient, on Fresnel's, 148.
- Cook (G.) on the inertia of a sphere moving in a fluid, 350.
- Copper, on the spectrum of, 457.
- Darwin (C. G.) on the dynamical motions of charged particles, 537.
- Das (Prof. A. B.) on the quantum theory of electric discharge, 233.
- David (Major W. T.) on the radiation emitted in gaseous explosions, 66, 84; on the specific heat of carbon dioxide and steam, 551.
- Davies (Miss A. C.) on critical velocities for electrons in helium, 592.
- Dey (A.) on the sounds of splashes, 145.
- Diffraction of waves by a screen with a straight edge, on the, 668.
- Dynamical motions of charged particles, on the, 537.
- Egerton (Capt. A. C.) on the determination of chemical constants, 1.
- Electric current, on the equivalent shell of a, 134; on the contributions to the, from the polarization and magnetization electrons, 404.
- discharge, on the quantum theory of, 223.
- energy, on the difference between magnetic and, as a pressure, 662.
- Electrical circuit, on the period and decrement of an oscillatory, 553.
- conductivity, on the relation between illumination and, in selenium, 482.
- Electrical oscillations, on the measurement of the frequency of, 289.
- Electrons, on spheroidal, 175; on the contributions to the electric current from the polarization and magnetization, 404; on the dynamical motions of, 537; on critical velocities for, in helium, 592.
- Elements, on the X-ray spectra of the, 694.
- Energy, on mass, radiation, and, 679.
- Entropy-temperature diagrams of certain fluids, on the, 633.
- Equation of state, on the, 456.
- Everett (Miss A.) on a simple property of a refracted ray, 223.
- Ewing (Sir J. A.) on the specific heat of saturated vapour and the entropy-temperature diagrams of certain fluids, 633.
- Explosions, on the radiation emitted in, 66, 84.
- Flint (H. T.) on applications of quaternions to the theory of relativity, 439.
- Fluids, on the inertia of spheres moving in, 350; on the entropy-temperature diagrams of certain, 633.
- Fluorescence, on light absorption and, 565.
- Fokker (Dr. A. D.) on the contributions to the electric current from the polarization and magnetization electrons, 404.
- Gaseous explosions, on the radiation emitted in, 66, 84.
- Gases, on the relation of the chemical constant to the behaviour of, at low temperatures, 21; on the magnetic susceptibilities of, 305; on the velocity of, in pipes, 505.
- Geological Society, proceedings of the, 383, 698.
- Gravitation, on, 488.
- Gravitational field, on the propagation of light in a, 586; on the path of a ray of light in the, of the sun, 626; on radioactivity and the, 659.
- Green (Dr. G.) on a fluid analogue for the aether, 651.
- Hackh (Prof. I. W. D.) on a table of the radioactive elements, 155.

- Hammick (D. L.) on latent heat and surface energy, 32.
- Hargreaves (R.) on the difference between magnetic and electric energies as a pressure, 662.
- Heat, on latent, and surface energy, 32, 238; on the, radiated from a cylindrical wall, 359; on problems in the conduction of, 603.
- Helium, on critical velocities for electrons in, 592.
- Hemsalech (G. A.) on the excitation of the spectra of carbon, titanium, and vanadium by thermelectronic currents, 241.
- Hicks (Prof. W. M.) on the spectrum of copper, 457.
- Horton (Prof. F.) on critical velocities for electrons in helium, 592.
- Hot-wire anemometer, on the, 505.
- Hydrogen and air, on the radiation emitted in explosions of, 84; on the magnetic susceptibility of, 305; on the mass-spectrum of, 621.
- Illumination, on the relation between electrical conductivity and, in selenium, 482.
- Inertia of a sphere moving in a fluid, on the, 350.
- Jackson (L. C.) on variably coupled vibrations, 294.
- Jeffreys (Dr. H.) on turbulence in the ocean, 578.
- Joly (Prof. J.) on the separation of lead into isotopes by centrifuging, 372; on the effect of centrifuging certain alloys while in the liquid state, 376.
- Jones (I.) on the period and decrement of an oscillatory electric current, 553.
- Jones (L. A.) on the measurement of the visibility of objects, 96.
- Krypton, on the mass-spectrum of, 623.
- Kunz (Prof. J.) on the scattering of light by dielectric spheres, 416.
- Latent heat and surface energy, on, 32, 238.
- Lead, on the separation of, into isotopes, 372.
- Lewis (Prof. W. C. McC.) on the application of the quantum theory to chemical reactions, 26.
- Light, on the scattering of, by dielectric spheres, 416; on the scattering of, by air, 423; on the propagation of, in a gravitational field, 586; on the path of a ray of, in the gravitation field of the sun, 626.
- absorption and fluorescence, on, 565.
- Lindemann (Prof. F. A.) on the significance of the chemical constant, 21.
- Livens (G. H.) on the mathematical relations of the magnetic field, 673.
- Lodge (Sir O. J.) on a possible structure for the æther, 170.
- Magnetic and electric energies, on the difference between, as a pressure, 662.
- field, on the mathematical relations of the, 673.
- induction of a circular current, on the, 134.
- susceptibilities of hydrogen and other gases, on the, 305.
- Majorana (Prof. Q.) on gravitation, 488.
- Mallik (Prof. D. N.) on the quantum theory of electric discharge, 233.
- Marr (Prof. J. E.) on the Pleistocene deposits around Cambridge, 699.
- Mass, energy, and radiation, on, 679.
- Mass-spectra of chemical elements, on the, 611.
- Mercury, on the mass-spectrum of, 623.
- Morton (Prof. W. B.) on the construction of a parabolic trajectory, 157.
- Muszkat (Miss A.) on the beta-recoil, 690.
- Neon, on the constitution of atmospheric, 449; on the mass-spectrum of, 619.
- Nitrogen, on the magnetic susceptibility of, 327; on the rate of solution of, by water, 385; on the mass-spectrum of, 621.
- Observations, on the adjustment of, 177.
- Ocean, on turbulence in the, 578.
- Oscillations, on the measurement of high-frequency, 289.
- Owen (S. P.) on radiation from a cylindrical wall, 359.

- Oxygen, on the magnetic susceptibility of, 320; on the rate of solution of, by water, 385; on the mass-spectrum of, 519.
- Parabolic trajectory, on the construction of a, 157.
- Pendulums, on coupled, 294.
- Perihelion of a planet, on the advance of the, 626.
- Photographic rendering of contrasts, on the, 151.
- Physical phenomena, on the processes occurring in, 679.
- Pipes, on the velocity of gases in, 505.
- Poole (J. H. J.) on the separation of lead into isotopes by centrifuging, 372; on the effect of centrifuging certain alloys while in the liquid state, 376.
- Prescott (Dr. J.) on the buckling of deep beams, 194.
- Quantum theory and chemical reactions, on the, 26; of spectrum emission, on the, 46; of electric discharge, on the, 223.
- Quaternions, applications of, to the theory of relativity, 439.
- Radiation emitted in gaseous explosions, on the, 66, 84; from a cylindrical wall, on, 359; on mass, energy, and, 679; on the beta-recoil, 690.
- Radioactive elements, on a table of the, 155.
- Radioactivity and the gravitational field, on, 659.
- Raman (Prof. C. V.) on the sounds of splashes, 145; on a mechanical violin-player, 535.
- Rankine (Prof. A. O.) on the relation between illumination and conductivity in selenium, 482; on the propagation of light in a gravitational field, 586.
- Ray (S.) on the equivalent shell of a circular current, 134.
- Rayleigh (the late Lord) on resonant reflexion of sound from a perforated wall, 225.
- Refracted ray, on a simple property of a, 223.
- Relativity, on parametric solutions for a fundamental equation in the theory of, 285; on an alternative view of, 433; applications of quaternions to the theory of, 439.
- Renwick (F. F.) on the photographic rendering of contrasts, 151.
- Resonant reflexion of sound, on the, 225.
- Rudorf (Dr. G.) on latent heat and surface energy, 238.
- Saha (S. N.) on the equation of state, 456.
- Sand (Dr. H. J. S.) on the cadmium vapour arc lamp, 678.
- Selenium, on the relation between illumination and electric conductivity in, 482.
- Silberstein (Dr. L.) on the quantum theory of spectrum emission, 46; on the recent eclipse results and Stokes-Planck's æther, 161; on the measurement of time, 366; on the propagation of light in a gravitational field, 586.
- Silver-lead alloys, on the effect of centrifuging, 376.
- Sky, on the blue colour of the, 423.
- Slate (Prof. F.) on an alternative view of relativity, 433.
- Soné (T.) on the magnetic susceptibilities of hydrogen and other gases, 305.
- Sound, on resonant reflexion of, from a perforated wall, 225.
- Specific heat of gases, on the, 551; of saturated vapour, on the, 633.
- Spectra, on the excitation of the, of carbon, titanium, and vanadium by thermoelectronic currents, 241; on the mass-, of chemical elements, 611; on the X-ray, of the elements, 694.
- Spectrum emission, on the quantum theory of, 46.
- of copper, on the, 457.
- Spheres, on the inertia of, moving in a fluid, 350; on the scattering of light by dielectric, 416.
- Splashes, on the sounds of, 145.
- Steam, on the specific heat of, 551.
- Sun, on the path of a ray of light in the gravitation field of the, 626.
- Surface energy, on latent heat and, 32, 238.
- Thermoelectronic currents, on the excitation of the spectra of carbon, titanium, and vanadium by, 241.
- Thomas (H. H.) on the geology of Palestine, 383.
- Thomas (J. S. G.) on the hot-wire anemometer, 505.

- Thomson (Sir J. J.) on mass, energy, and radiation, 679.
- Time, on the measurement of, 366.
- Titanium, on the excitation of the spectrum of, by thermelectronic currents, 241.
- Tobin (T. C.) on the construction of a parabolic trajectory, 157.
- Turbulence in the ocean, on, 578.
- Tykocinski-Tykociner (J.) on the Mandelstan method of measurement of frequency of electrical oscillations, 289.
- Vanadium, on the excitation of the spectrum of, by thermelectronic currents, 241.
- Vapour, on the specific heat of saturated, 633.
- Vapour-pressure formula, on the integration constant of the, 1, 21.
- Vibrations, on variably coupled, 294.
- Violin-player, on a mechanical, 535.
- Visibility, on an instrument for the measurement of, 96.
- Water, on the rate of solution of nitrogen and oxygen by, 385; on the molecular rotational frequencies of, 565.
- Waves, on the diffraction of, by a screen with a straight edge, 668.
- Whiddington (Prof. R.) on the X-ray spectra of the elements, 694.
- Wood (Prof. R. W.) on light scattering by air and the blue colour of the sky, 423.
- X-ray spectra of the elements, on the, 694.
- Xenon, on the mass-spectrum of, 623.
- Zinc oxide, on the crystalline structure of, 647.

END OF THE THIRTY-NINTH VOLUME.

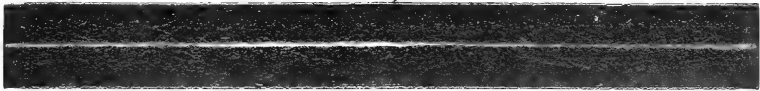

1

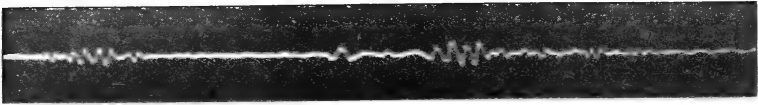

2

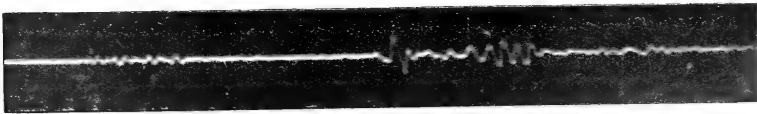

3

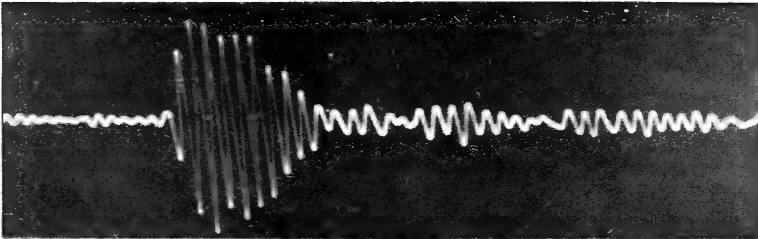

4



5

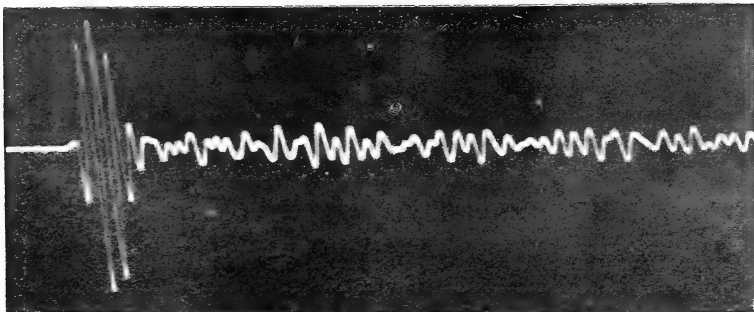

6

Records of the Sounds of Splashes.

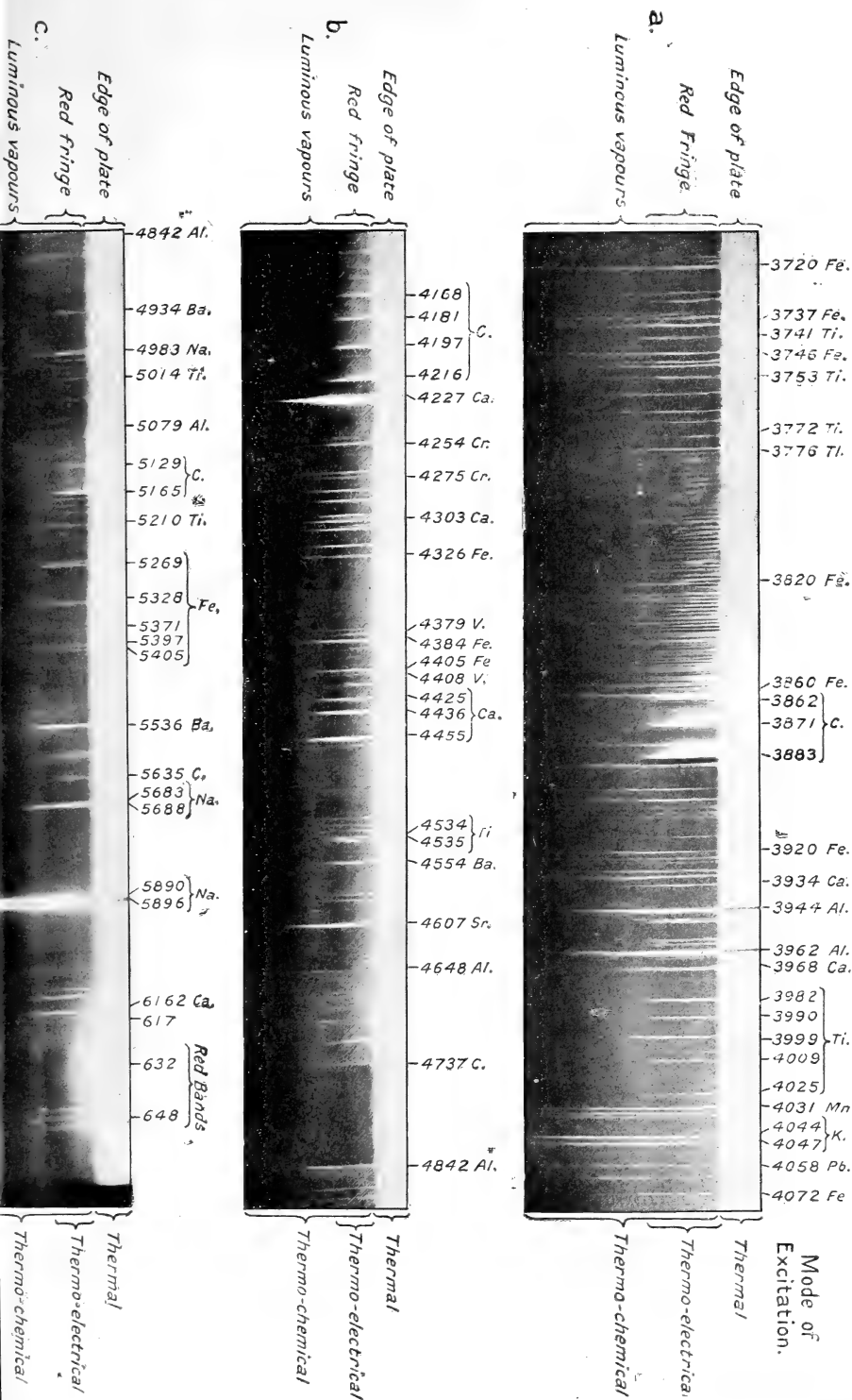

Spectrum of Red Fringe and Luminous Vapours.

Influence of feeble magnetic fields on Visibility of Red Fringe Emission.

Plate temperature : 2700° C. Drop of potential along plate : 5.8 volts.
 Intensity of magnetic field : 175 C.G.S. units. cm.

a. Without magnetic field

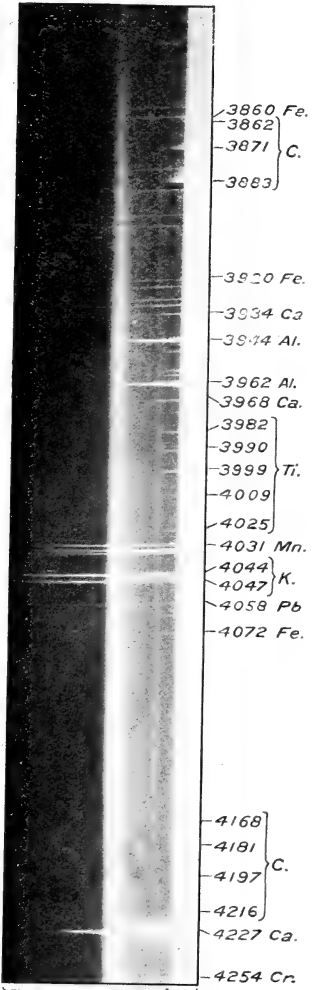

Edge of plate
 Red fringe
 Bluish vapour
 Luminous vapours

b. Magnetic force acting downwards

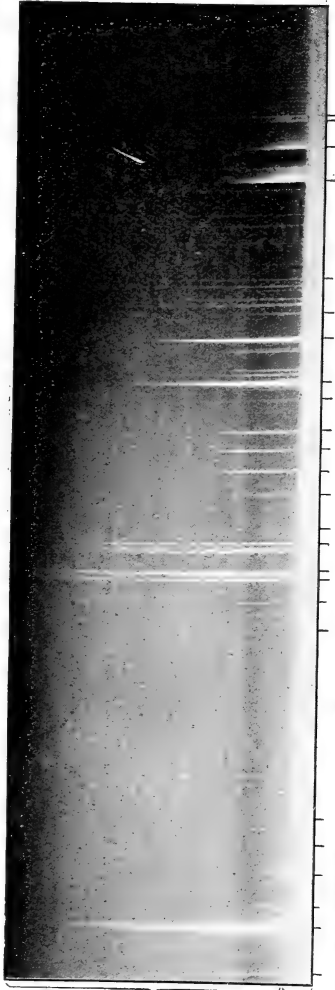

Edge of plate
 Red fringe
 Luminous vapours & spiral patches

c. Magnetic force acting upwards

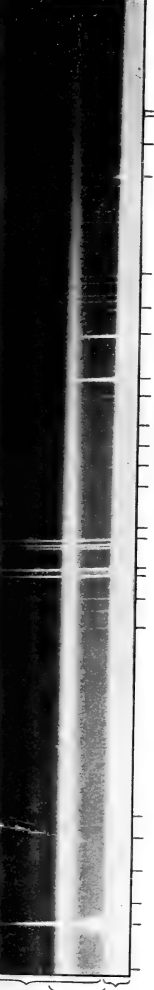

Edge of plate
 Bluish vapour
 Luminous vapours



Compression and Expansion of Red Fringe Emission by Magnetic Fields.

Plate temperature : 3000° C. Drop of potential along plate : 7 $\frac{\text{volts}}{\text{cm.}}$

Intensity of magnetic field : 590 C.G.S. units.

a. Magnetic force acting upwards

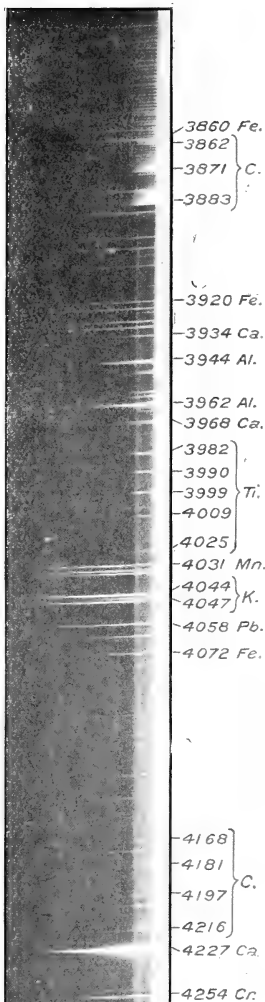

} Edge of plate
} Red fringe
Luminous vapours

b. Magnetic force acting downwards

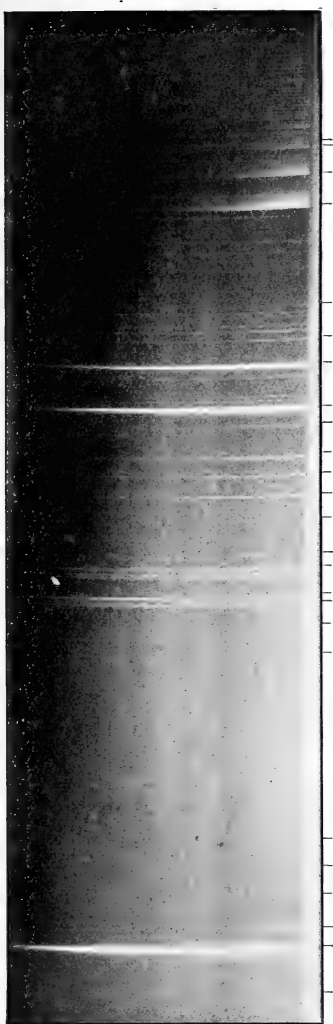

} Edge of plate
} Red fringe,
} Luminous vapours
} & spiral paths

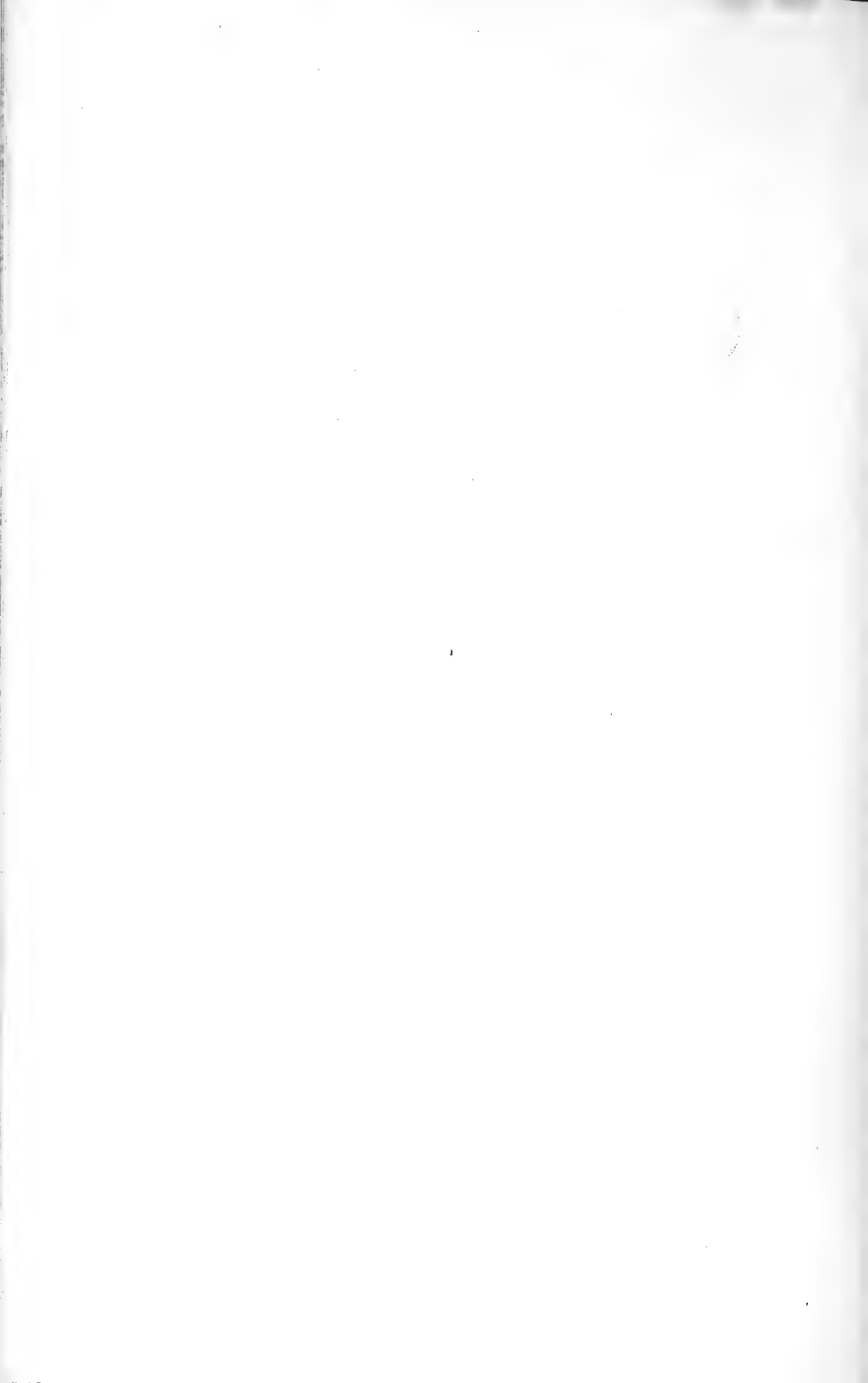

Appearance of Red Fringe Emission above Plate under impulsion of an upwards acting Magnetic Force.

Plate temperature : 3000° C. Drop of potential along plate : $7 \frac{\text{volts}}{\text{cm.}}$
 Intensity of magnetic field : 1300 C.G.S. units.

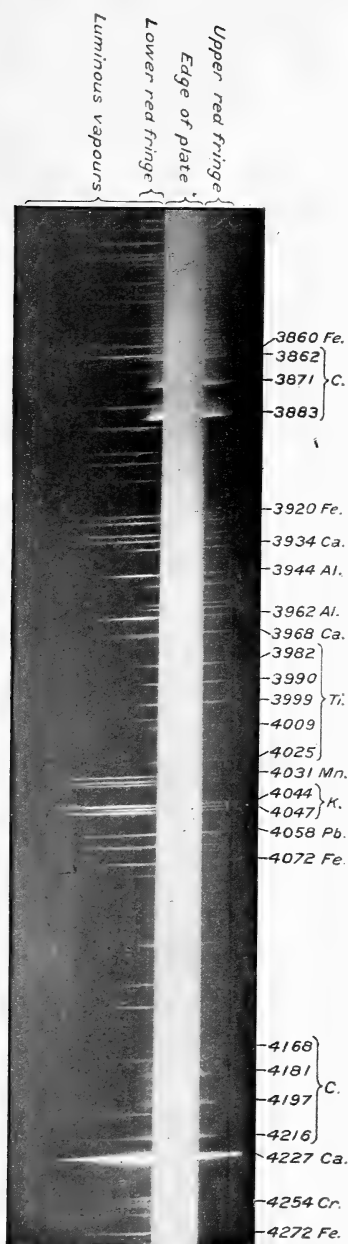



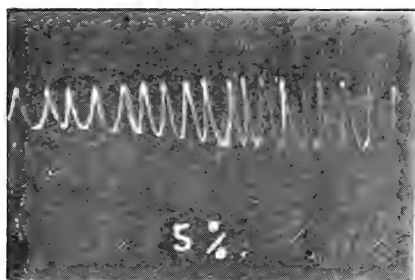

1

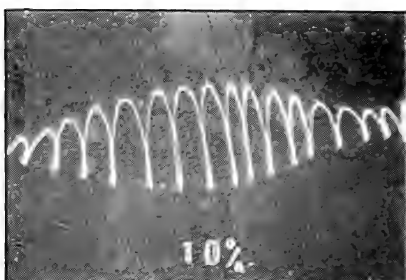

2

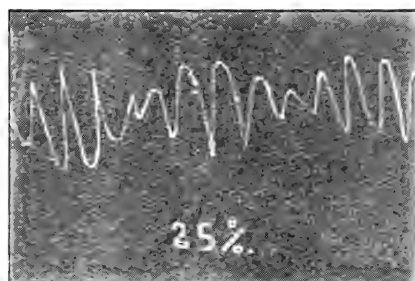

5

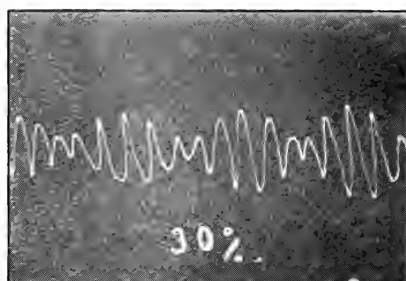

6

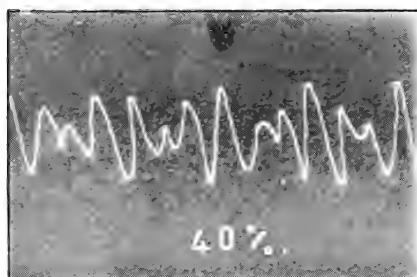

9

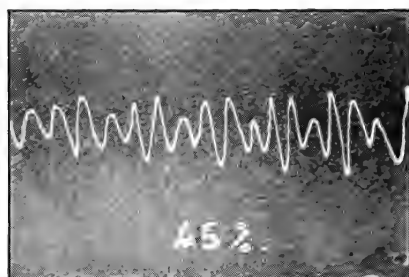

10

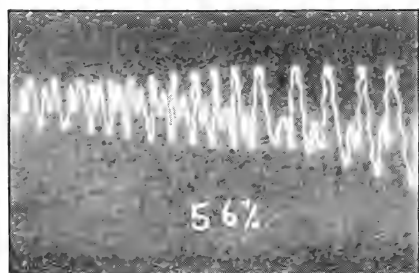

13

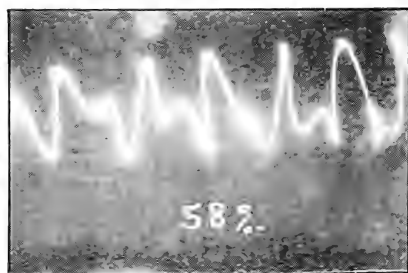

14

Upper Bob struck.

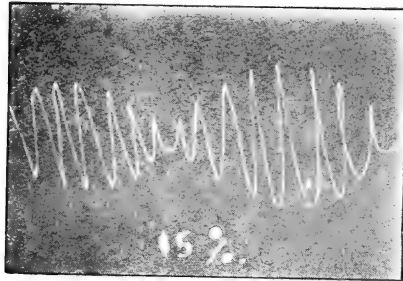

3

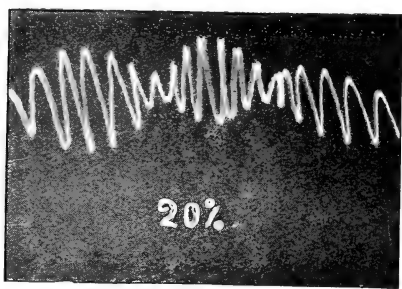

4

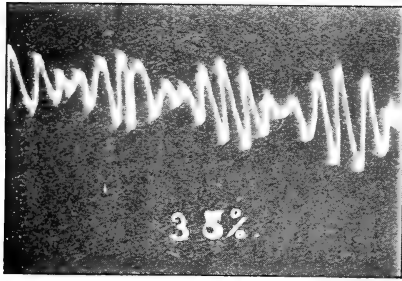

7



8

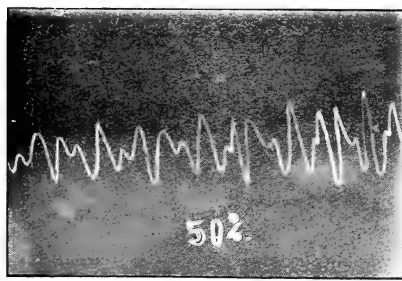

11

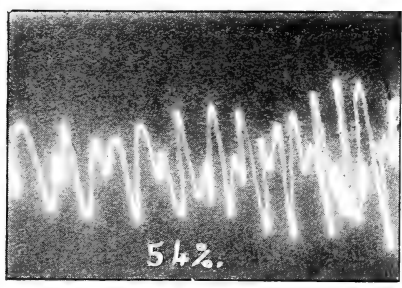

12

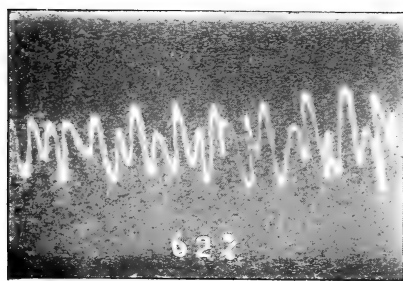

15



16

Traces of Lower Bob when Upper Bob struck.

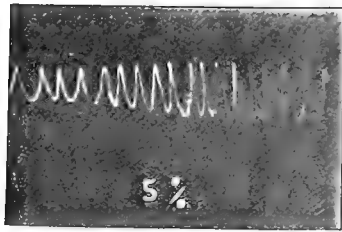

5%

1

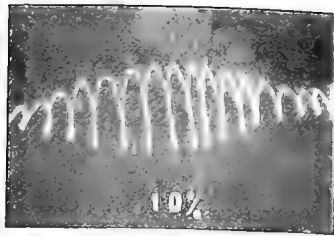

10%

2

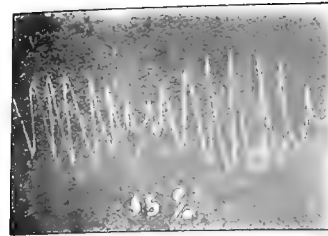

15%

3



20%

4

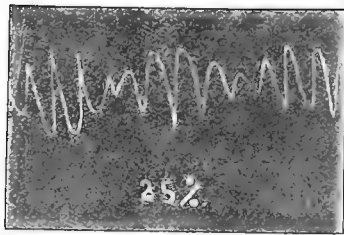

25%

5

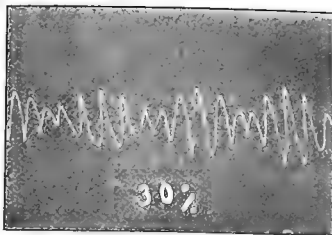

30%

6

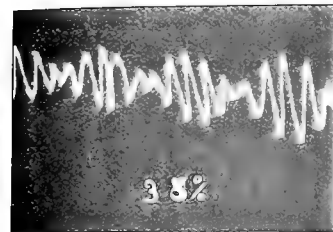

35%

7



38%

8

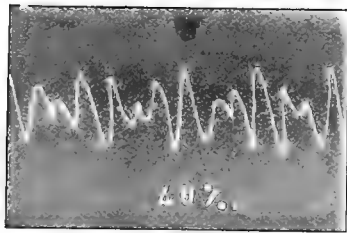

40%

9

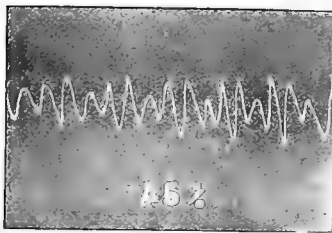

45%

10

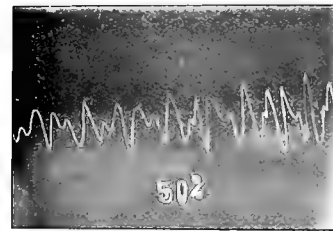

50%

11

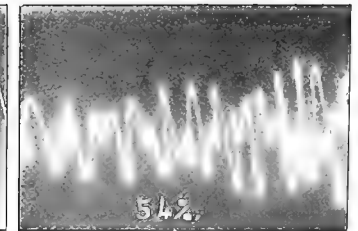

54%

12

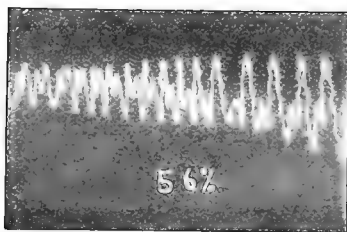

56%

13

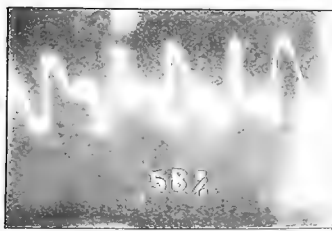

58%

14

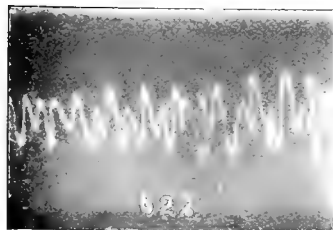

62%

15

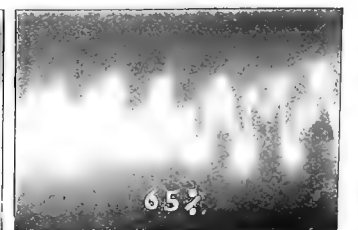

65%

16



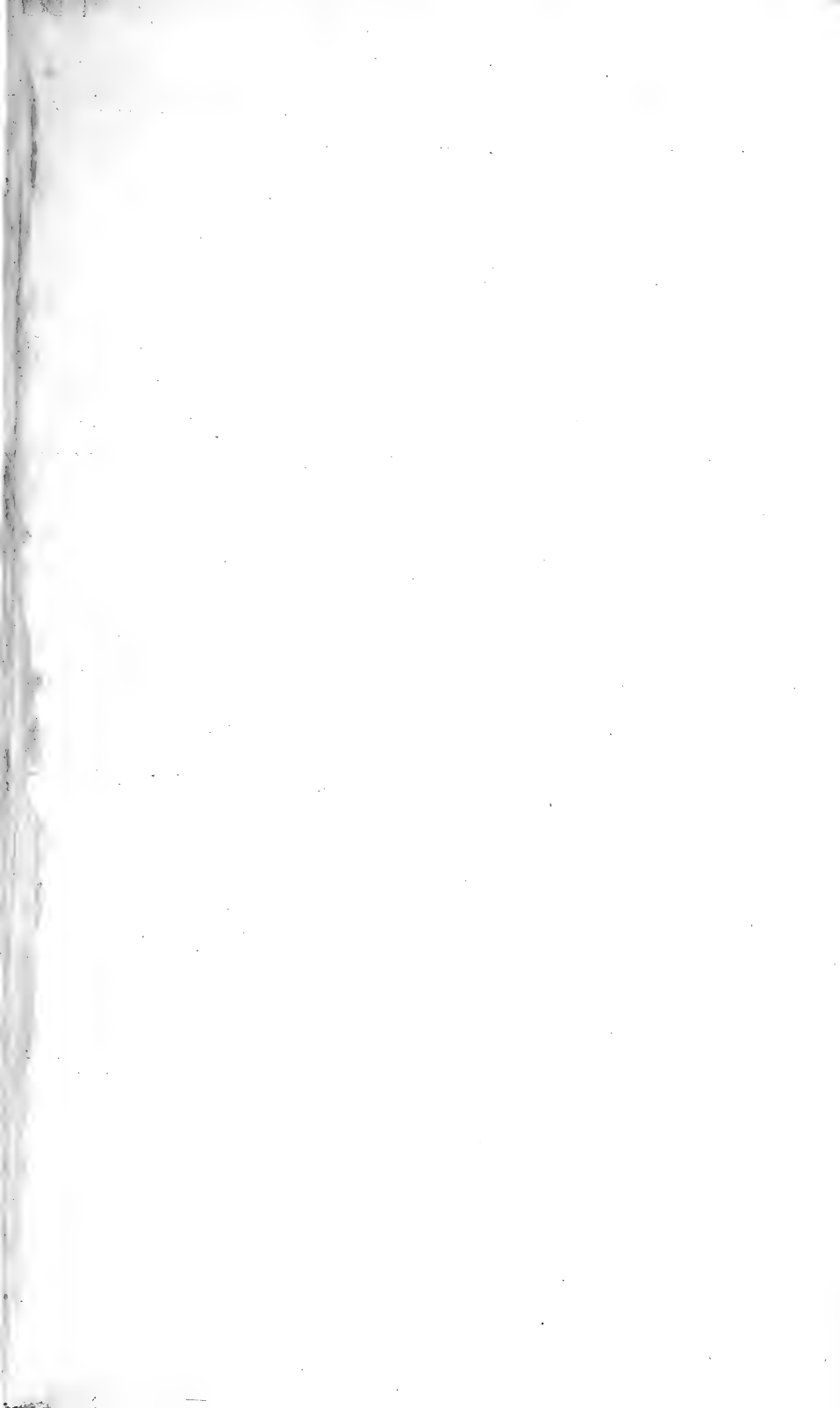

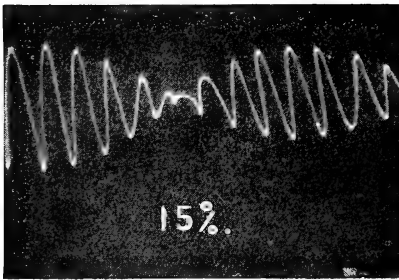

17

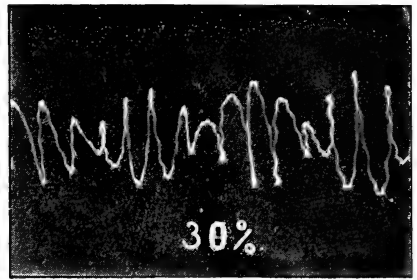

18

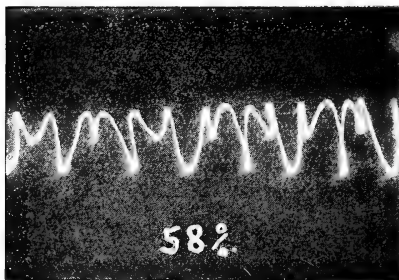

21

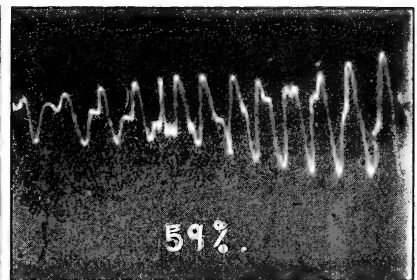

22

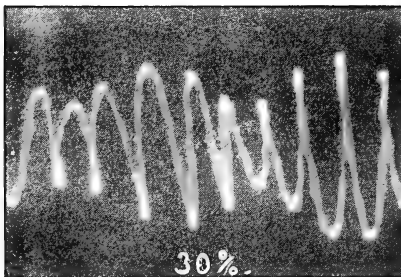

25

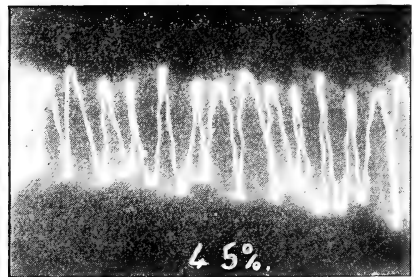

26

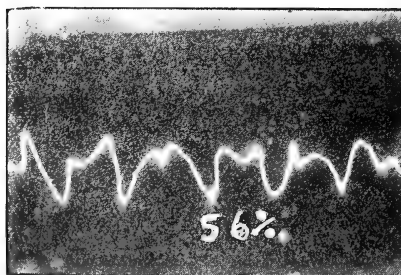

29

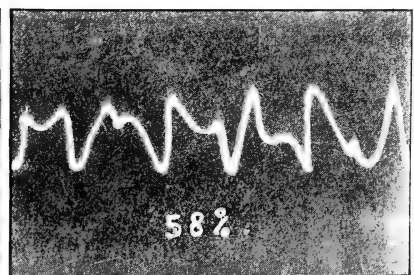

30

per Bob displaced.

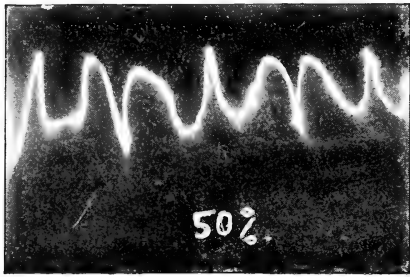

19

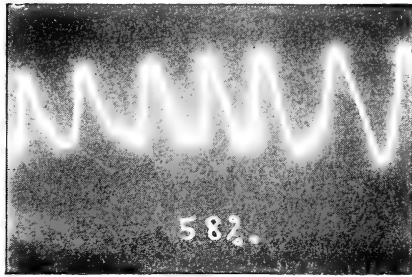

20

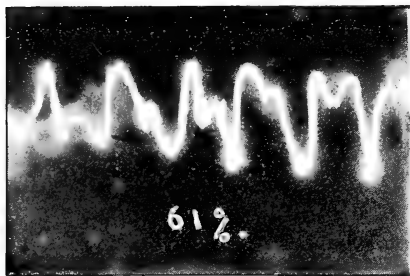

23

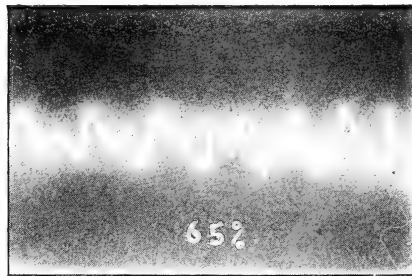

24

ver Bob displaced.

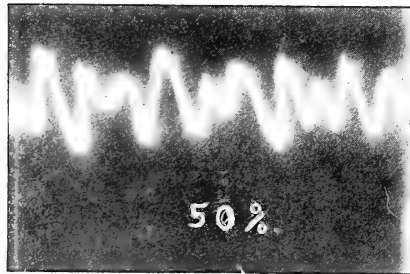

27

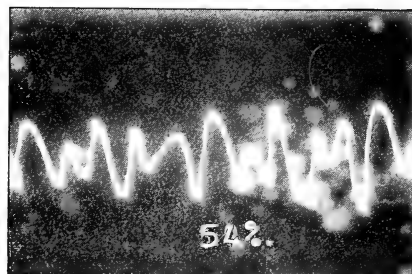

28

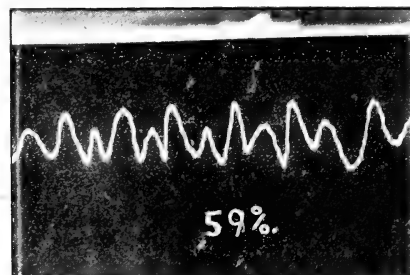

31

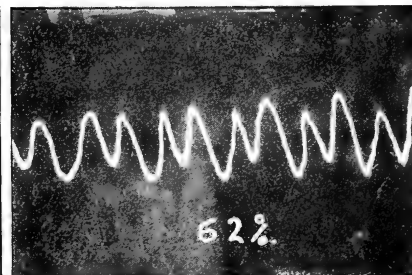

32



Traces of Lower Bob when Upper Bob displaced.

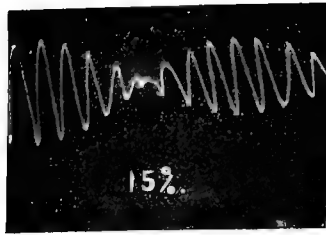

17

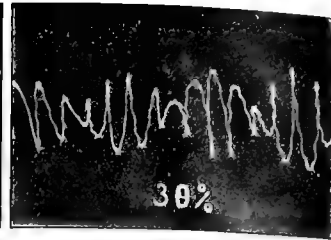

18



21



22



19



20

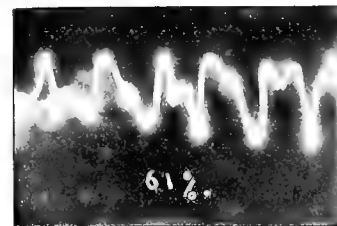

23

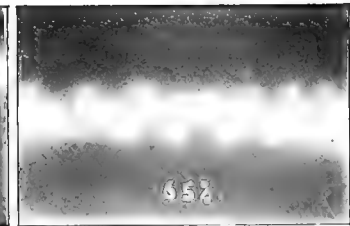

24

Traces of Lower Bob when Lower Bob displaced.

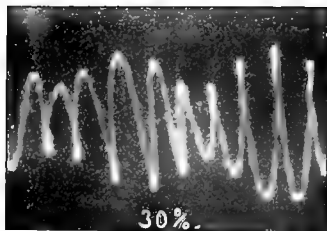

25

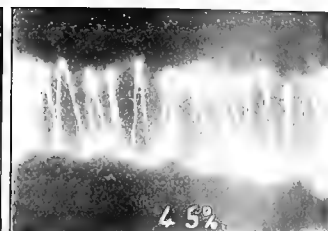

26

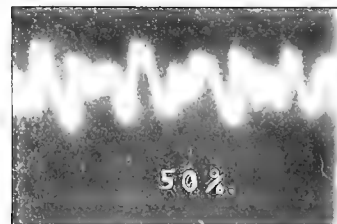

27

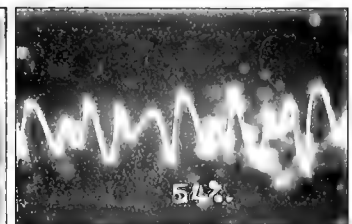

28

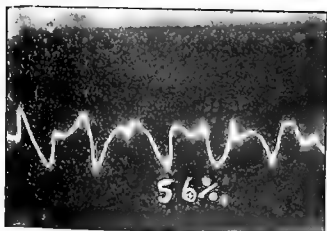

29

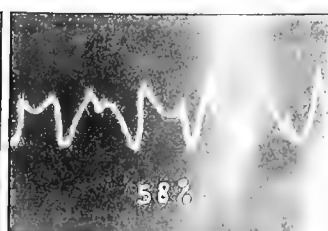

30

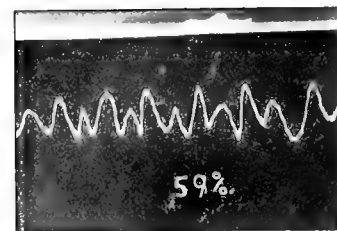

31

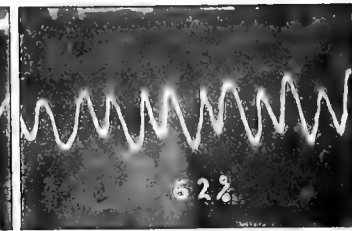

32

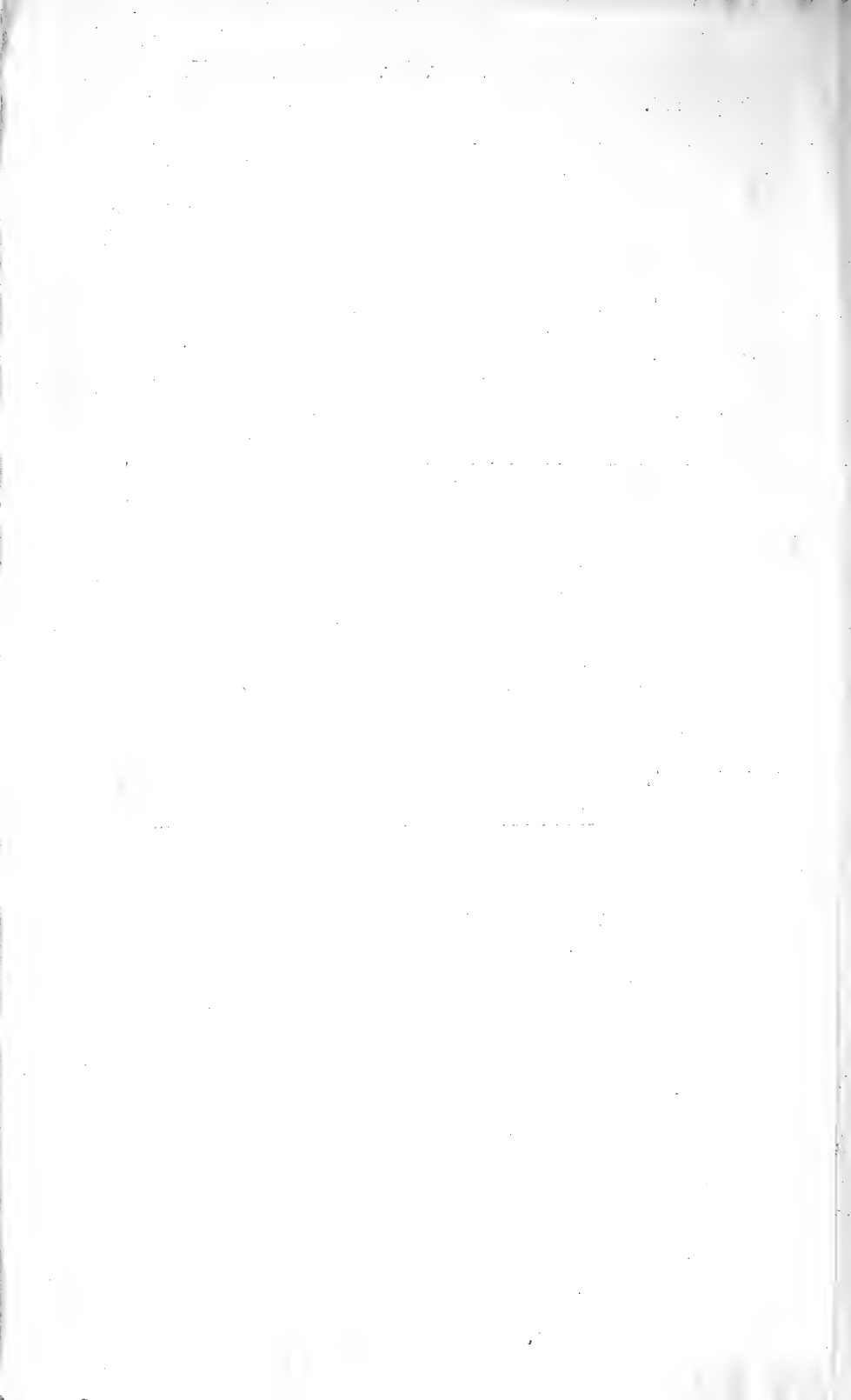

CO Ne^β Ne^α

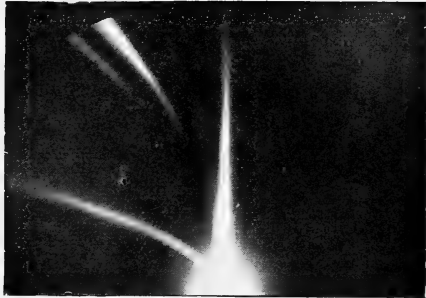

CO Ne^β Ne^α

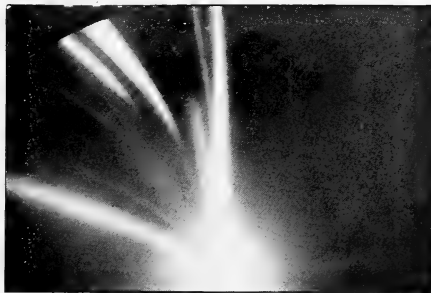







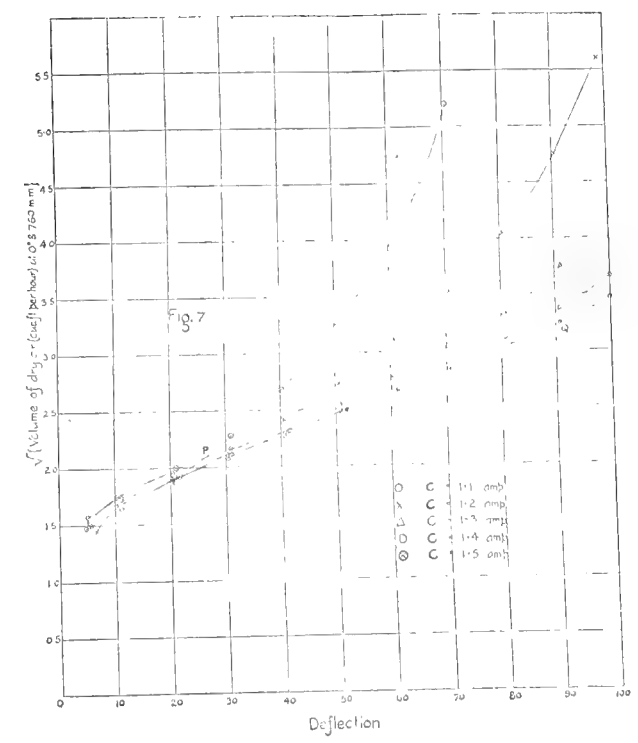
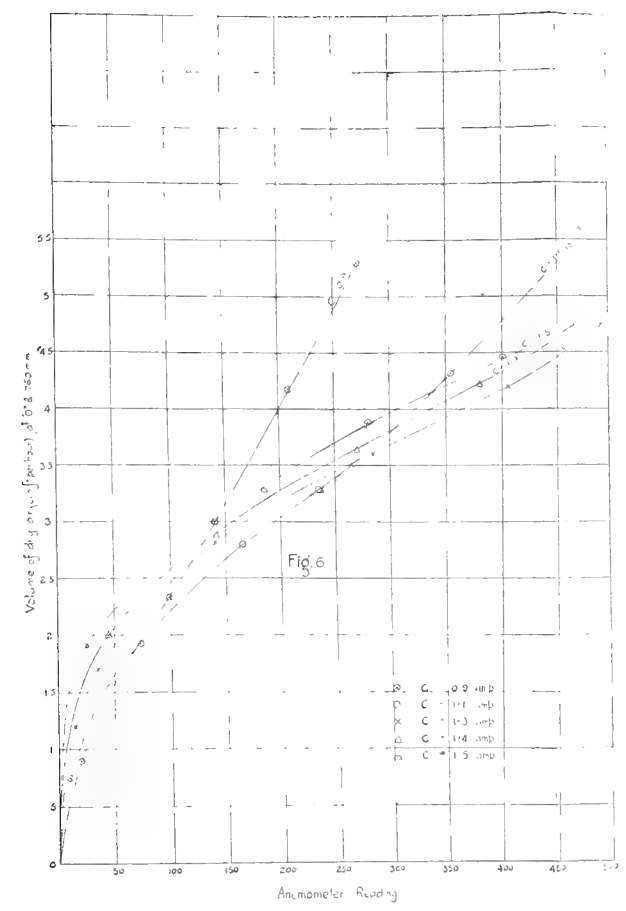
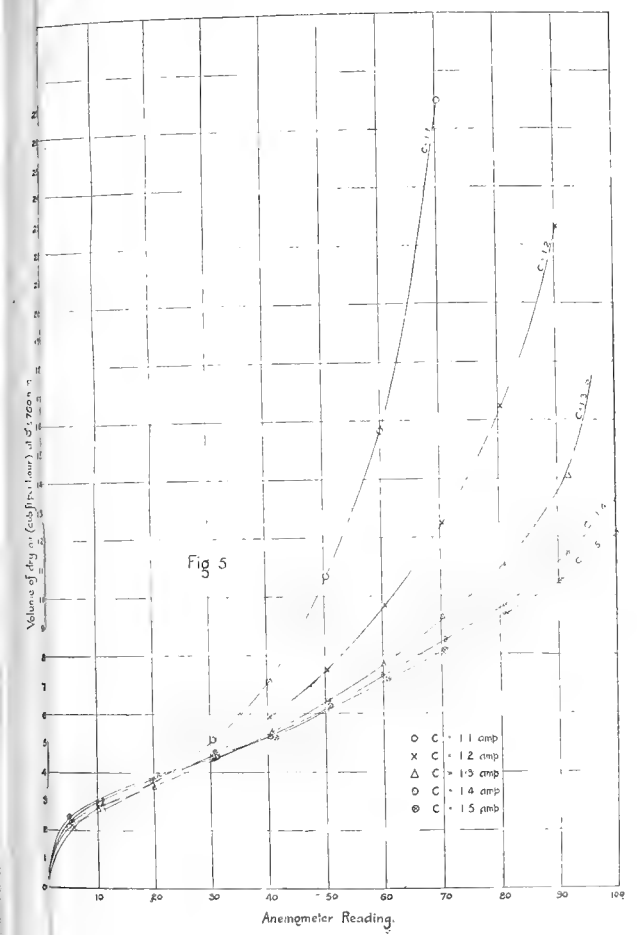



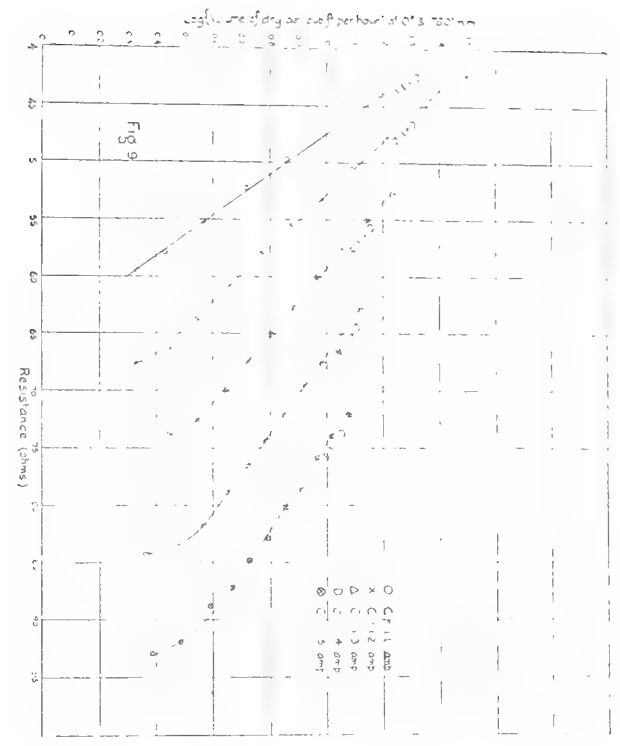
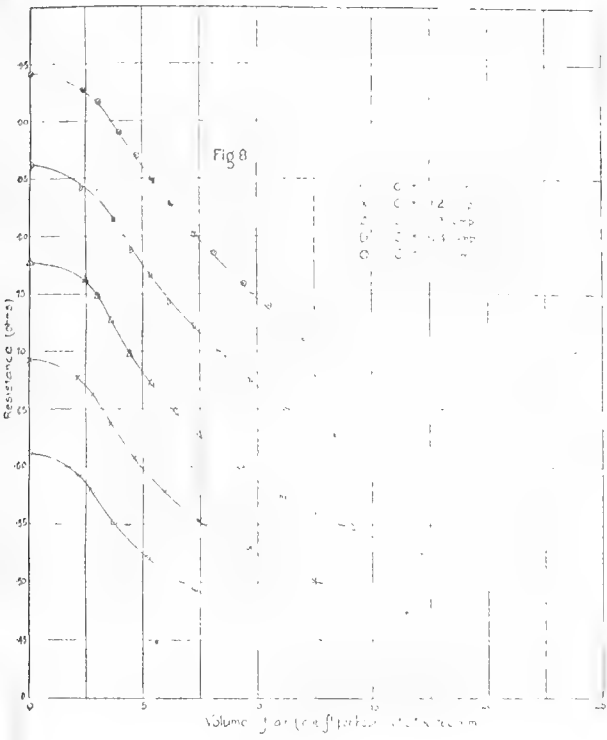

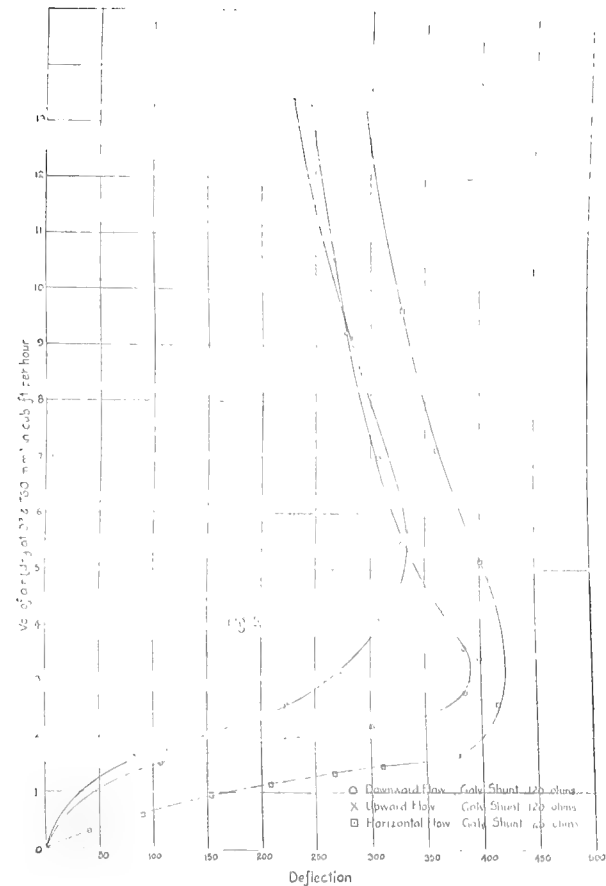
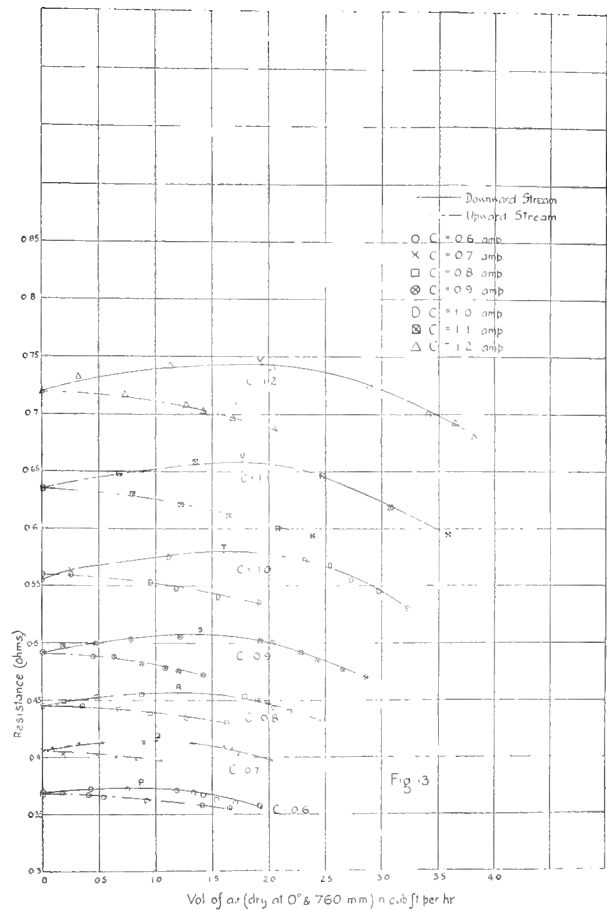
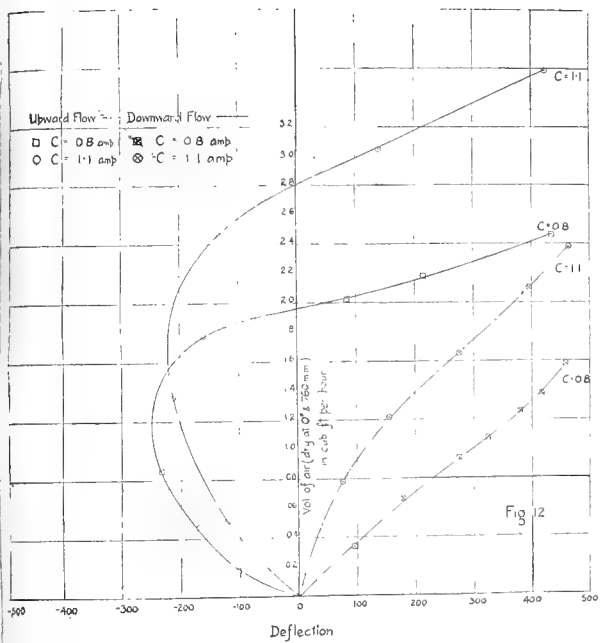

Ratio: Resistance of exposed arm
Resistance of shielded arm

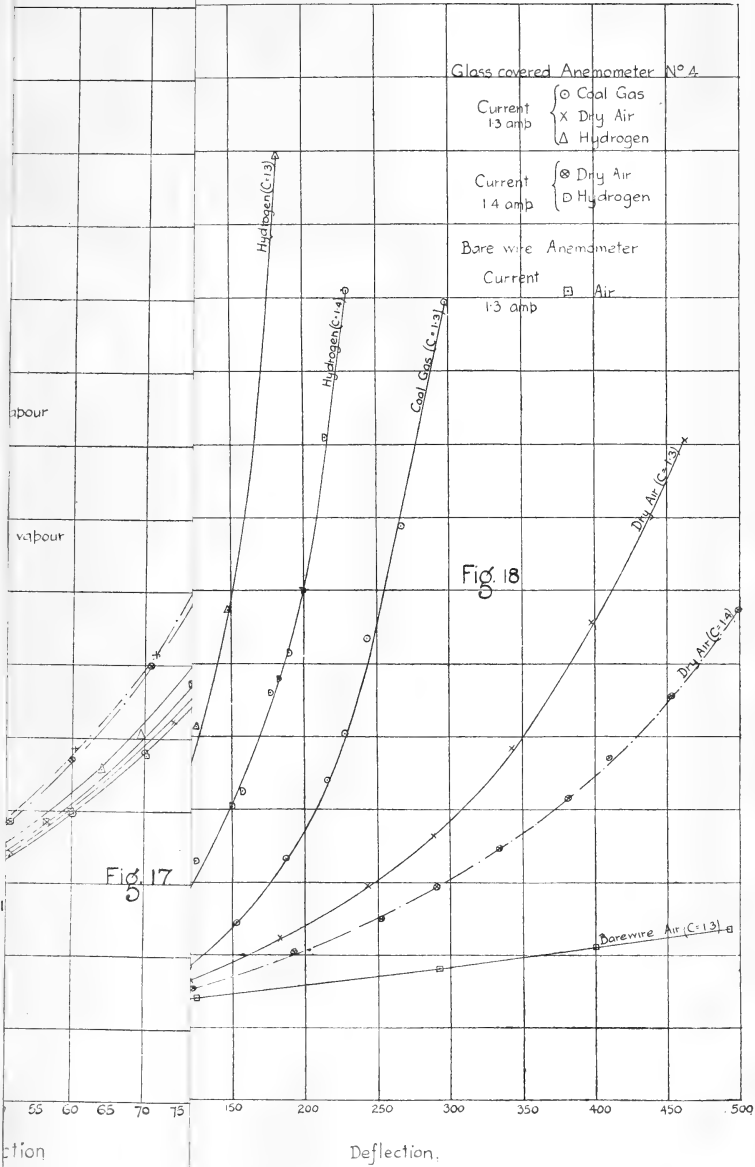

about
vapour

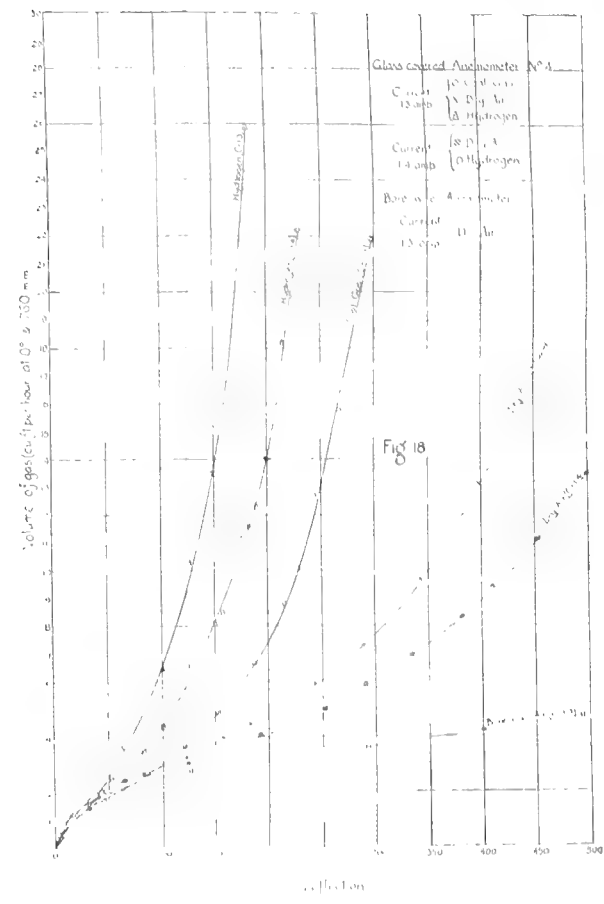
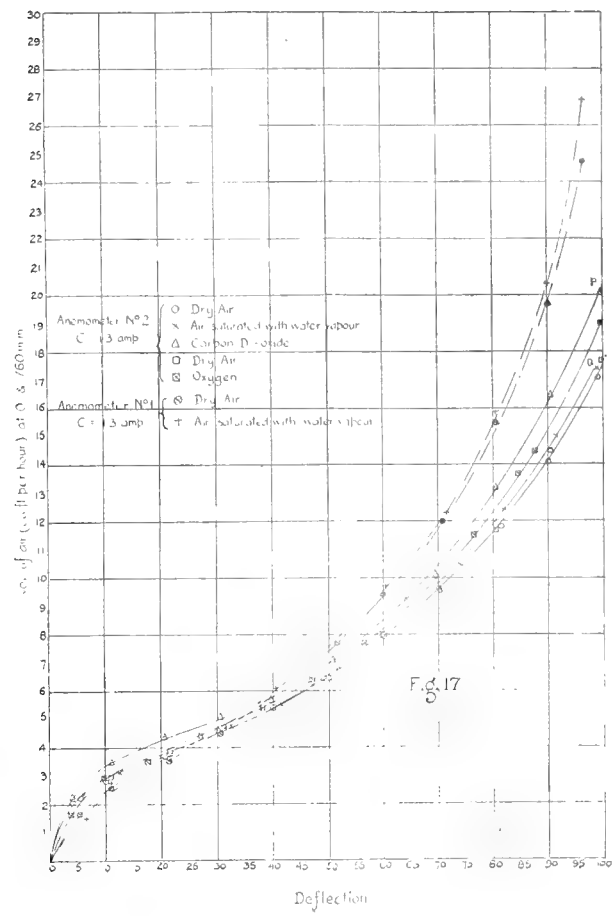
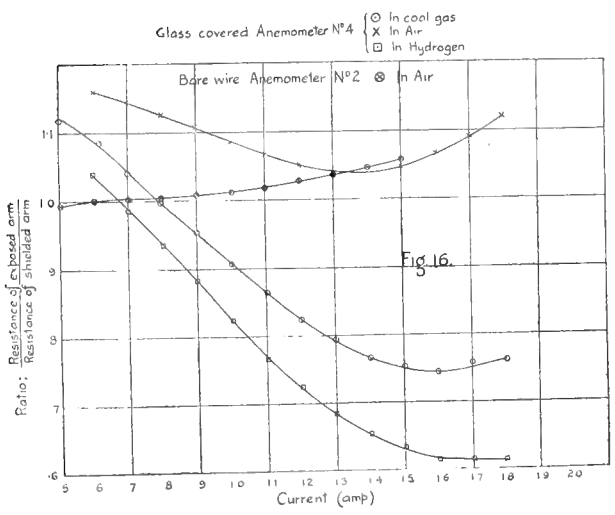
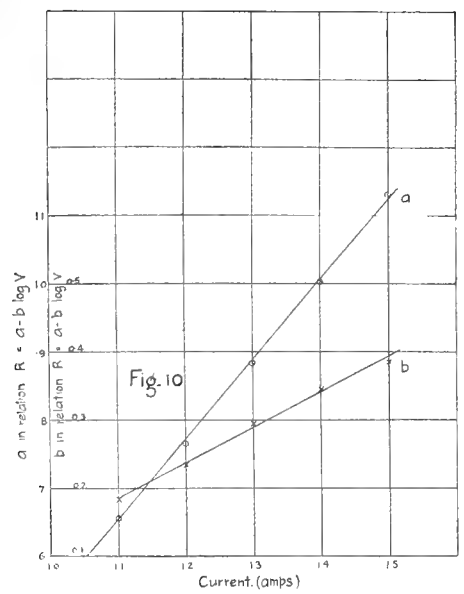

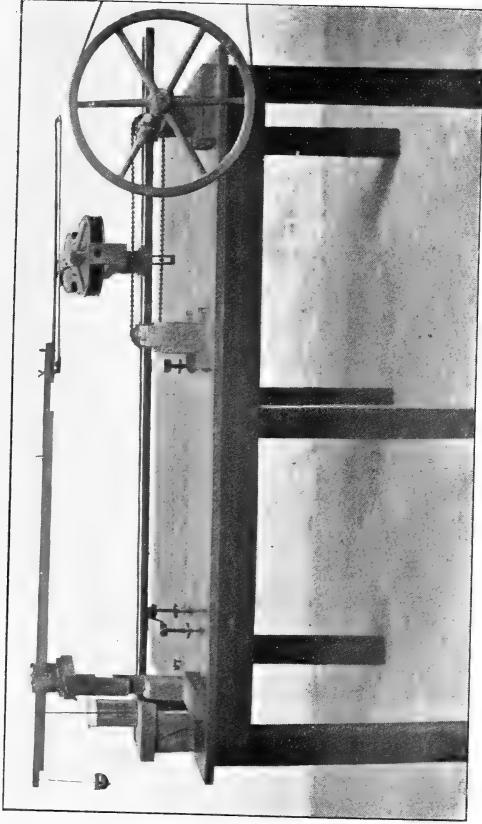

A Mechanical Violin-Player for Acoustical Experiments.



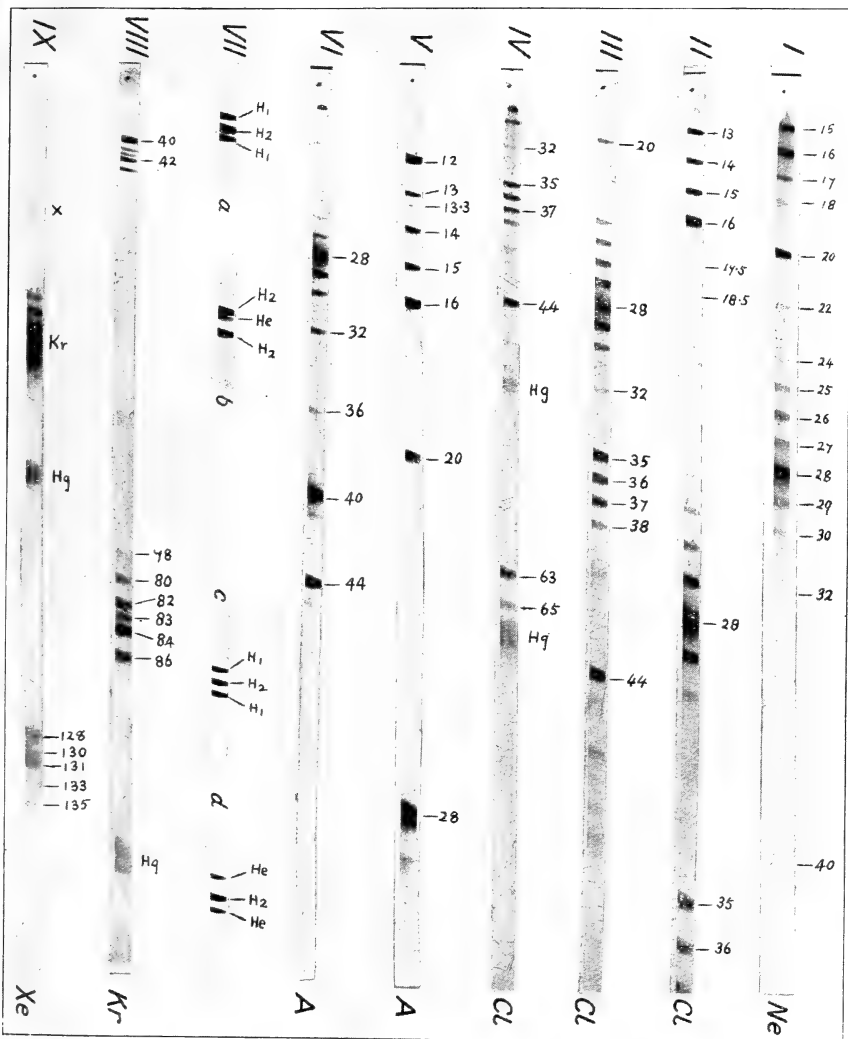



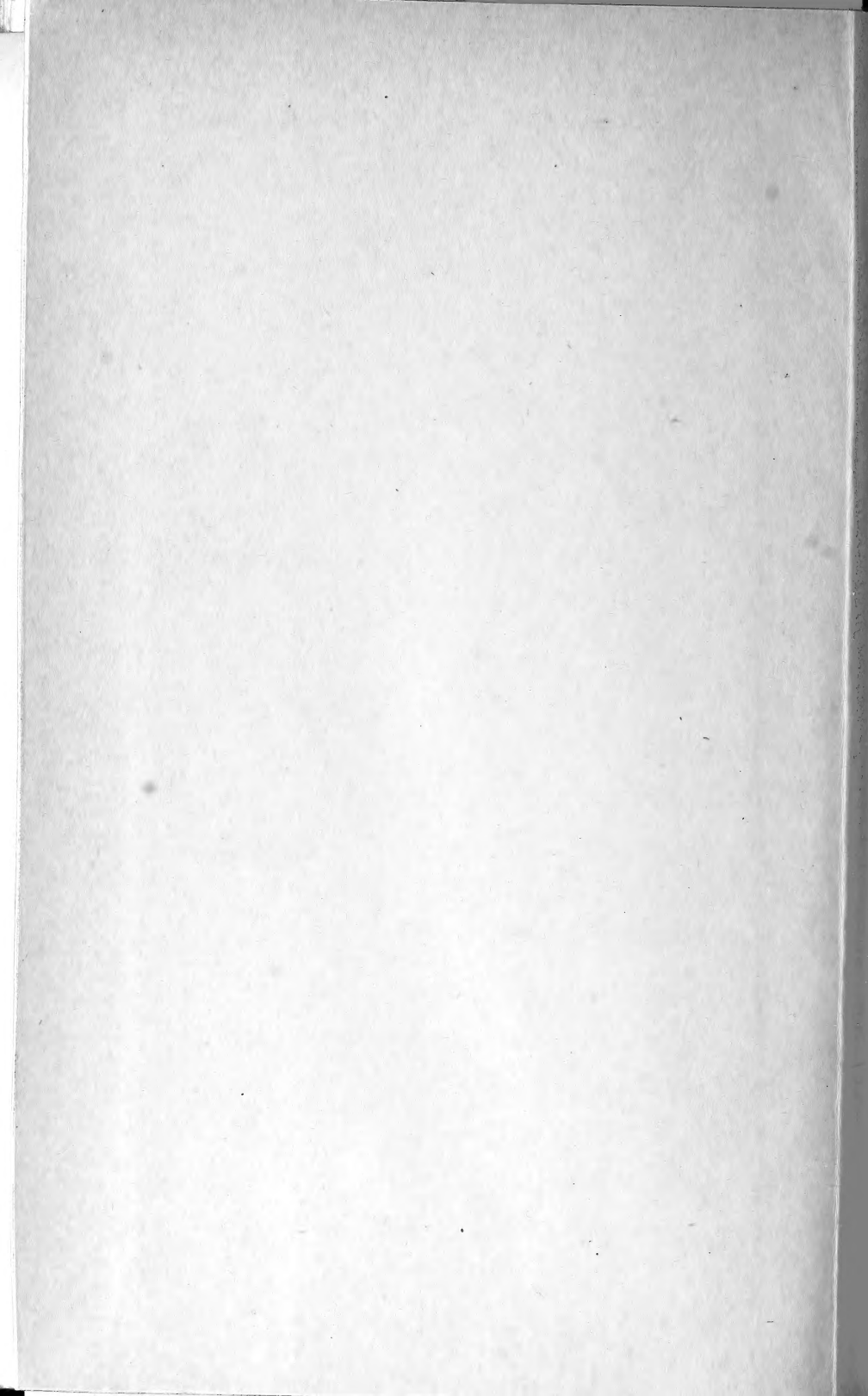



SMITHSONIAN INSTITUTION LIBRARIES



3 9088 01202 5052